

03PTMBPN0406BR-V1

PRESSURE TREATED MATCHBOARD PENT BAR 4X6.

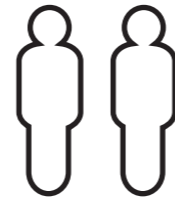

x2

All buildings should be erected by two adults



2mm Drill bit

For ease of assembly, you **MUST** pilot drill all screw holes and ensure all screw heads are countersunk.



For ease of assembly, you will need a tape measure to check dimensions of components and fixings.



Winter = High Moisture = Expansion
Summer = Low Moisture = Contraction



CAUTION

Every effort has been made during the manufacturing process to eliminate the prospect of splinters on rough surfaces of the timber. You are strongly advised to wear gloves when working with or handling rough sawn timber.

****Protim Aquatan T5 (621)****

Your building has been dip treated with Aquatan.

Aquatan is a water-based concentrate which is diluted with water, the building has been treated by the correct application of Aquatan solution and then allowed to dry.

Aquatan is a decorative finish to colour the wood, which is applied industrially to timber fence panels and garden buildings.

Aquatan undiluted contains: boric acid, sodium hydroxide 32% solution, aqueous mixture of sodium dioctyl sulphosuccinat and alcohols: 2, 4, 6-trichlorophenol.

REGISTER FOR YOUR
15 YEAR
ANTI-ROT
GUARANTEE TODAY

In all instances for assistance with your product or to register your anti rot guarantee, please contact us via our customer portal



www.mgplogistics.co.uk

Mercia Garden Products Limited, Sutton On Trent, Newark, Nottinghamshire, NG23 6QN

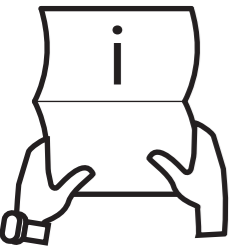

BEFORE YOU START PLEASE READ THE INSTRUCTIONS CAREFULLY

- Check the pack and make sure you have all the items listed in the parts list provided.
- When you are ready to start, make sure you have the right tools at hand (not supplied - see the equipment list on next page).
- Ensure there is plenty of space and a clean dry area for assembly.
- Ensure you have enough time to build the product to ensure the building is water tight.

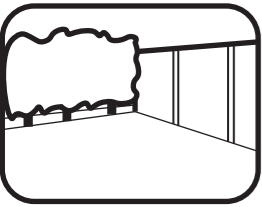

LOCATION FOR YOUR GARDEN BUILDING

A minimum of 600mm should be left around the perimeter of your garden building to allow access for maintenance, annual treatment and to allow air flow around the building.

Where possible you should avoid placing your garden building underneath large trees to prevent the tree causing damage to the building.

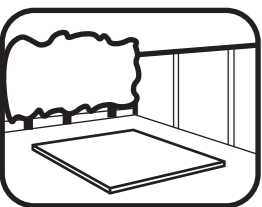

BUILDING A BASE

When thinking about where the building and where the base is going to be constructed: Ensure that there will be access to all sides for maintenance work and annual treatment.

Ensure the base is level and is built on firm ground, to prevent movement. Refer to the contents page for the base dimensions. The base should be slightly smaller than the external measurement of the building, i.e. The cladding should overlap the base, creating a run off for water. It is also recommended that the floor be at least 25mm above the surrounding ground level to avoid flooding.

TYPES OF BASE

- Concrete 75mm laid on top of 75mm hard-core.
- Slabs laid on 50mm of sharp sand.
- Wooden base - Levelled / on posts / ground screws.

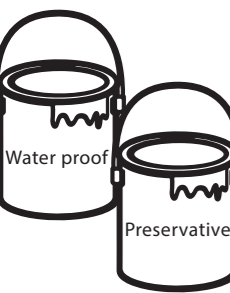

TREATMENT

Once your garden building has been installed it will need to be treated within 14 days (weather permitting) and annually to prevent the timber from deteriorating and to waterproof it. This is required to maintain the anti-rot guarantee.

Dip Treated buildings - Require a preservative treatment to protect against rot and decay and a waterproof treatment to prevent water ingress

Pressure Treated buildings - Require a waterproof treatment to prevent water ingress

Log Cabins/Insulated Garden Rooms - Are supplied untreated and require a preservative and waterproofing treatment.

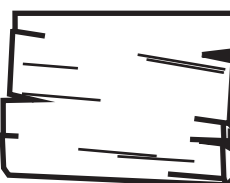

TIMBER

As with all natural materials, timber can be affected during various weather conditions. For the duration of heavy or extended periods of rain, swelling of the wood panels may occur. Warping of the wood may also occur during excessive dry spells due to an interior moisture loss. Unfortunately, these processes cannot be avoided but can be helped. It is suggested that the outdoor building is sprayed with water during extended periods of warm sunshine and sheltered as much as possible during rain or snow.

Whilst all products manufactured are made to the highest standards of safety and in the case of children's products independently tested to EN71 level, we cannot accept responsibility for your safety whilst erecting or using this product.

Screws & Nails

Measure overall length

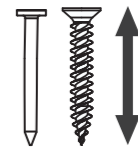

Bolts

Measure under the head

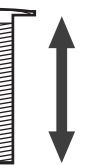

TO DO LIST

- Find a suitable location to build (*see front cover for further information*).
- Build a base (*see front cover for further information*).
- Check the base is flat, level, clear of debris and has 60cm clearance on all sides.
- Check you have the required equipment / tools.
- Check you have all the product items listed (*if you have missing or damaged parts please scan the QR code below to visit our online customer portal*).
- Install the product as per the step by step instructions within this pack.
- Prepare the product ready for treatment (this may include sanding).
- Apply a preserving and a waterproofing treatment within 14 days (*weather permitting*) of installation (*pressure treated products do not require a preserver*).
- Register for your anti rot guarantee (*scan the QR below*).
- Tidy the build area and dispose of any remaining parts responsibly.
- Maintain your building (*see the manufacturers recommendations at the back of this pack*).

EQUIPMENT LIST

- Hammer
- Flat Head Screwdriver
- Drill
- Drill Bit Set
- Phillips and Slotted Bit Sets
- Tape Measure
- Hand Saw
- Spirit Level
- Ladders/Steps
- Stanley Knife/Cutting Tool
- Sand Paper
- Gloves
- Silicone (For Windows Only)
- Sealant Application Gun
- Wood Filler (Optional)
- Timber Preservative Treatment (*not pressure treated products*)
- Timber Water Proofing Treatment
- Treatment Mixing Stick
- Paint Brush/Sprayer/Roller

NEED EXTRA SUPPORT

If you are unsure that your base preparation will be suitable, please contact us via our customer portal to discuss this further.

Alternatively, you can visit our website or MGP Logistics Online Portal for some further sheducation.

Website:

<https://www.merciagardenproducts.co.uk/sheducation>

MGP Logistics Online Portal:

<https://www.mgplogistics.co.uk/>

Here you will find plenty of useful information that'll help with most pre-installation and maintenance queries.

**ANY QUESTIONS?**

Scan the QR code to contact us via our customer portal.

NOTES

03PTMBPN0406BR-V1

Overall Dimensions:
 Width = 1966mm
 Depth = 1434mm
 Height = 2129mm

Base Dimensions:
 Width = 1824mm
 Depth = 1269mm

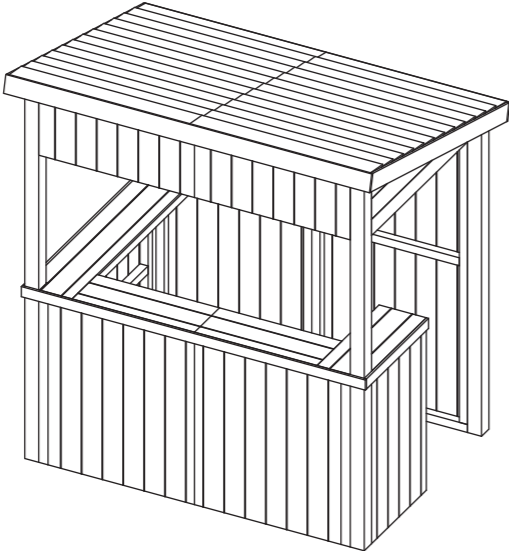

Building Contents:

Tip: Labelling your parts, using a pencil and masking tape, may help you to identify them easier when you need them.



1

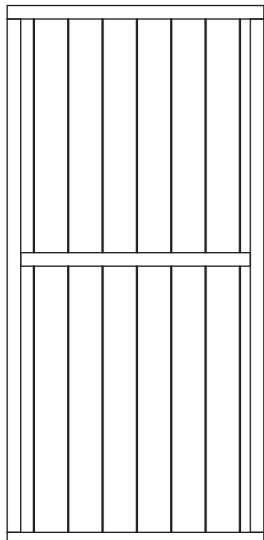

Back Panel QTY 2
AI-S22MBVCPP837X1762-V1

2

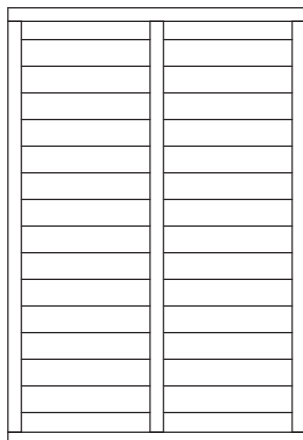

Roof QTY 2
AI-S22FEPR971X1428-V1

3

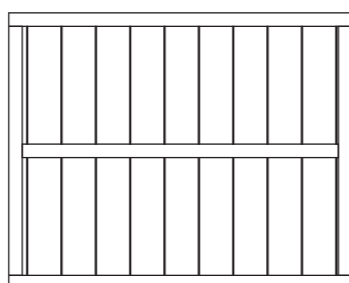

Left Plain Panel QTY 1
AI-S22MBVCPP1119X900-V1

4

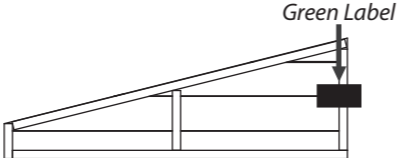

Right Gable QTY 1
AI-S21MBPGTR1119X393-V1

5

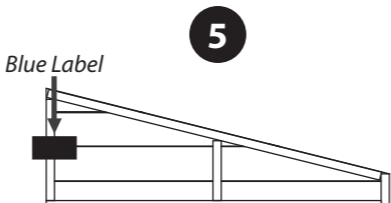

Left Gable QTY 1
AI-S21MBPGTL1119X393-V1

6

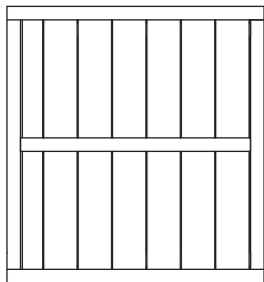

Front Panel QTY 2
AI-S22MBVCPP837X900-V1

7

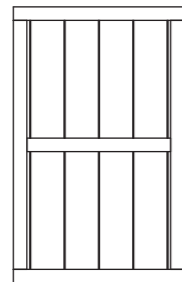

Right Plain Panel QTY 1
AI-S22MBVCPP557X900-V1

8

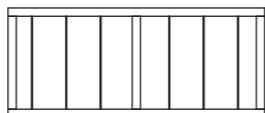

Top Panel QTY 2
AI-S21MBVCPP837X352-V1

10

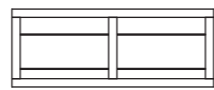

Plain Bar Top QTY 2
AI-03S21MBSHF658X254-V1

9

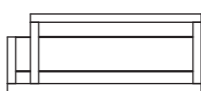

Right Bar Top QTY 1
AI-03S21MBSHFCO632X254-V1

11

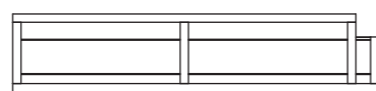

Left Bar Top QTY 1
AI-03S21MBSHFCO254X1194-V1

12

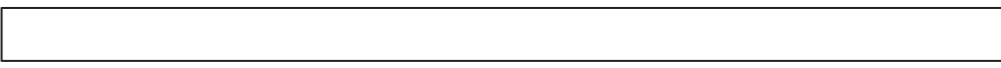

Ridge Bar 27x70x1674mm QTY 1
F2770-1674mm

End View

13

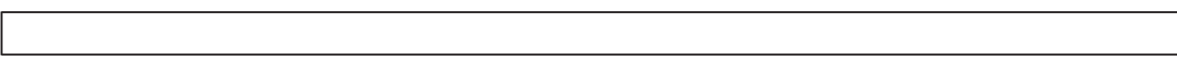

Front Cover Trim 12x56x1848mm QTY 1
S1256-1848mm

End View

14



Side Cover Trim 12x56x1269mm QTY 2
S1256-1269mm

End View

15

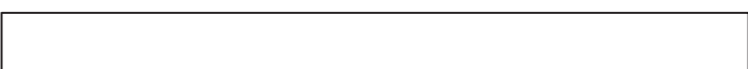

Roof Cover Trim 12x80x1130mm QTY 1
S1280-1130mm

End View

16



Fascias 12x95x1428mm QTY 2
S1295-1428mm

End View

17

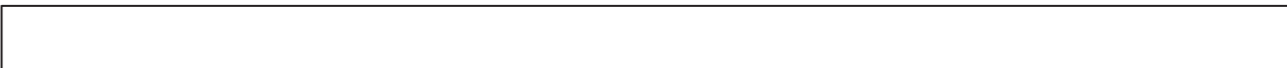

Side Fascia 12x95x1966mm QTY 2
S1295-1966mm

End View

18

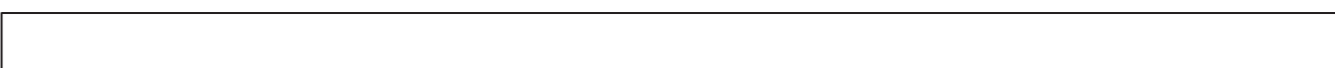

Front Post 75x75x2100mm QTY 2
PI-14-0306

End View

19



Back Post 75x75x1800mm QTY 2
PI-14-0304

End View

20

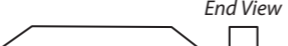

Bar Support 27x44x258mm QTY 2
F2744-G-298mm

End View

21



Corner Brace QTY 2
PI-07-0012

Screw Pack.

There may be extra screws present in the pack.

www.merciagardenproducts.co.uk P 3

Extension Pack
03PTMBPN0403BRPB-V1

Overall Dimensions:
Width = 2803mm
Depth = 1432mm
Height = 2140mm

Base Dimensions:
Width = 2661mm
Depth = 1269mm

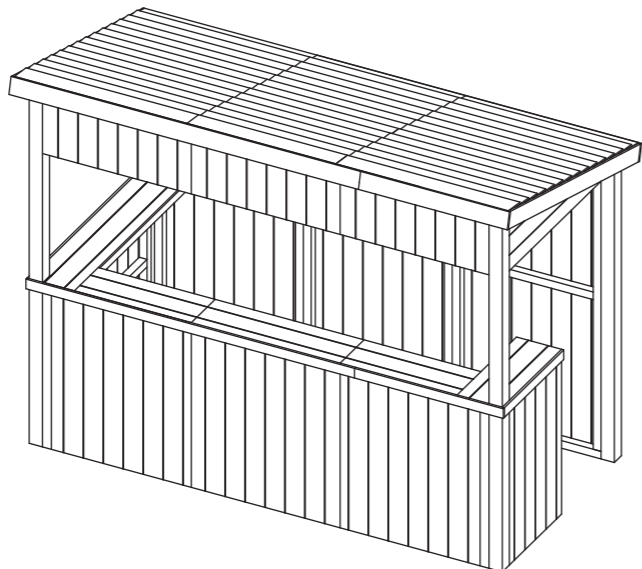

Extension Pack Contents:

Tip: Labelling your parts, using a pencil and masking tape, may help you to identify them easier when you need them.



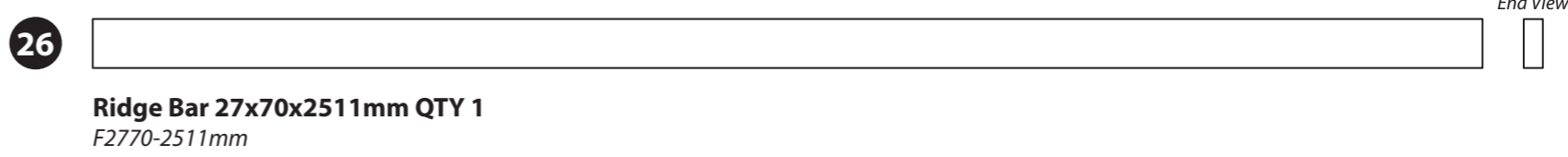
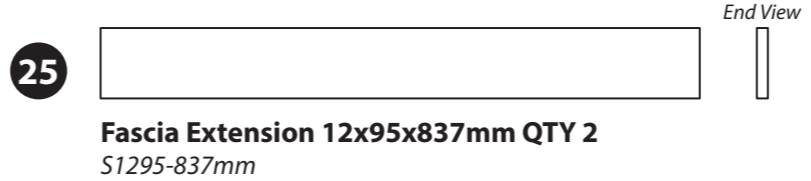
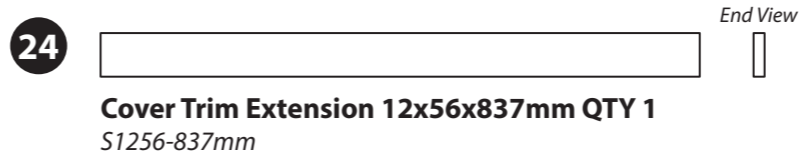
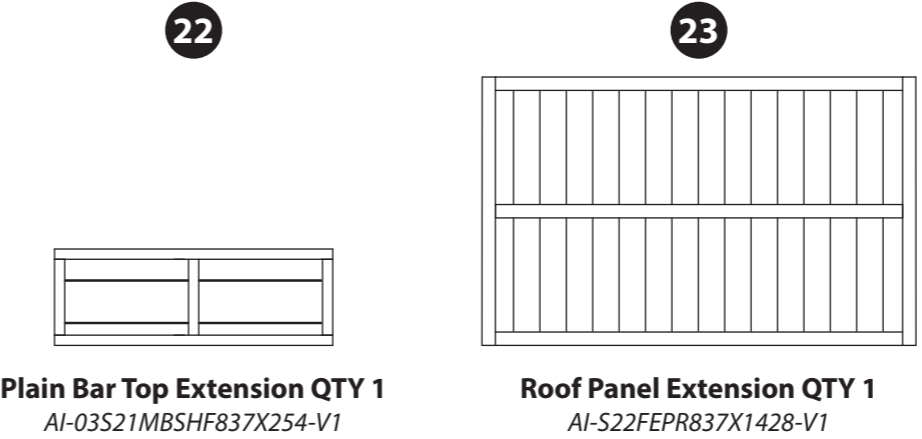
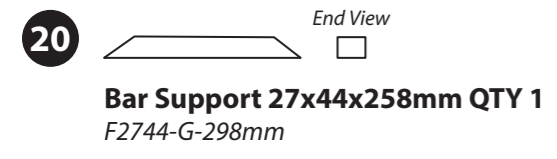
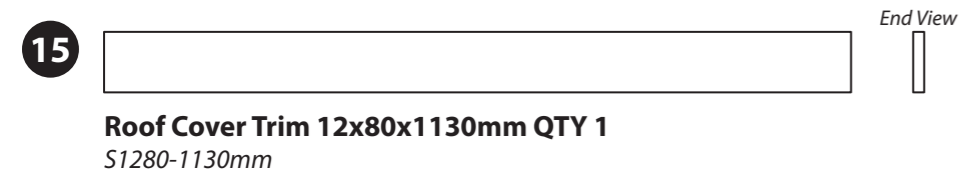
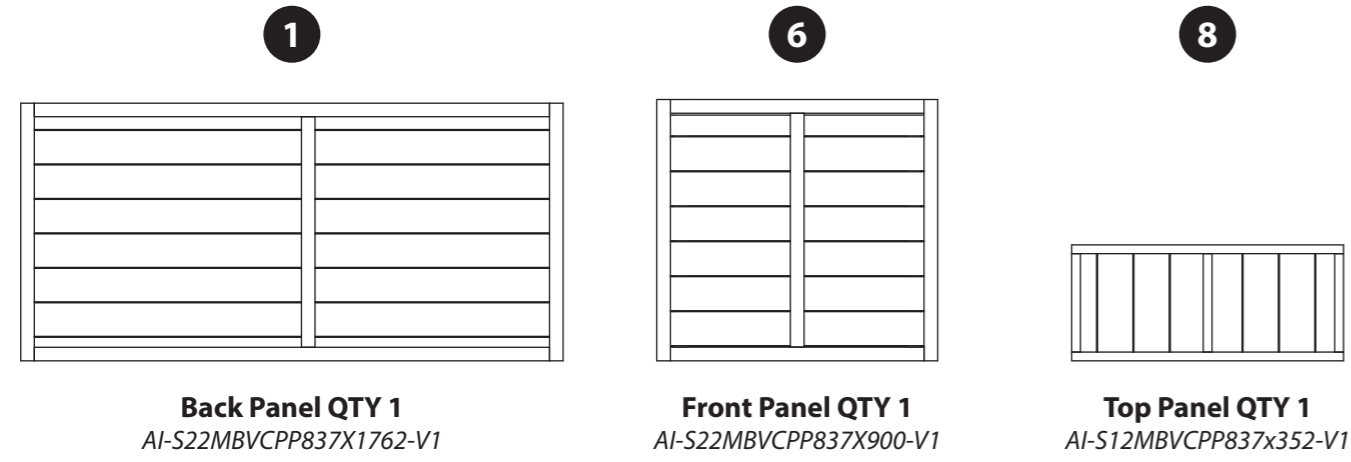

If Extension Pack has been purchased, please follow steps labelled 'Extension Pack' where present

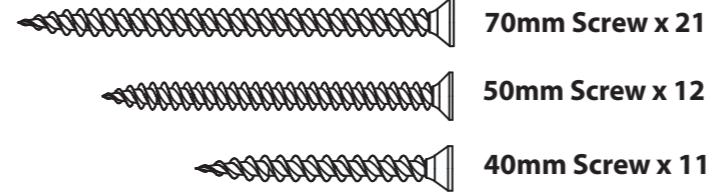

Screw Pack

There may be extra screws present in the pack.





Missing parts?
Scan the QR code to visit our customer portal where you can quickly raise any missing or damaged parts and get a replacement sent out ASAP.



Before assembly, please make sure you have a suitable base ready to install your building onto.

Step 1

Parts Needed - No. 1 QTY 2
- No. 19 QTY 2

Stand the Back Panels (No. 1) upright as shown, with the larger gap between the panel framing at the bottom, as per the measurements on the diagram. Fix together in an alternating pattern using 4x70mm screws

Place Corner Posts 75x75-1800mm (No. 19) to either side flush with the inside of the panel.

Attach the post (No. 19) to the back panel (No. 1) using 4x70mm screws per post, fixing through the panel into the post.

12x70mm Screws

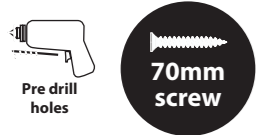

IMPORTANT: Pre-drill before fixing screws.

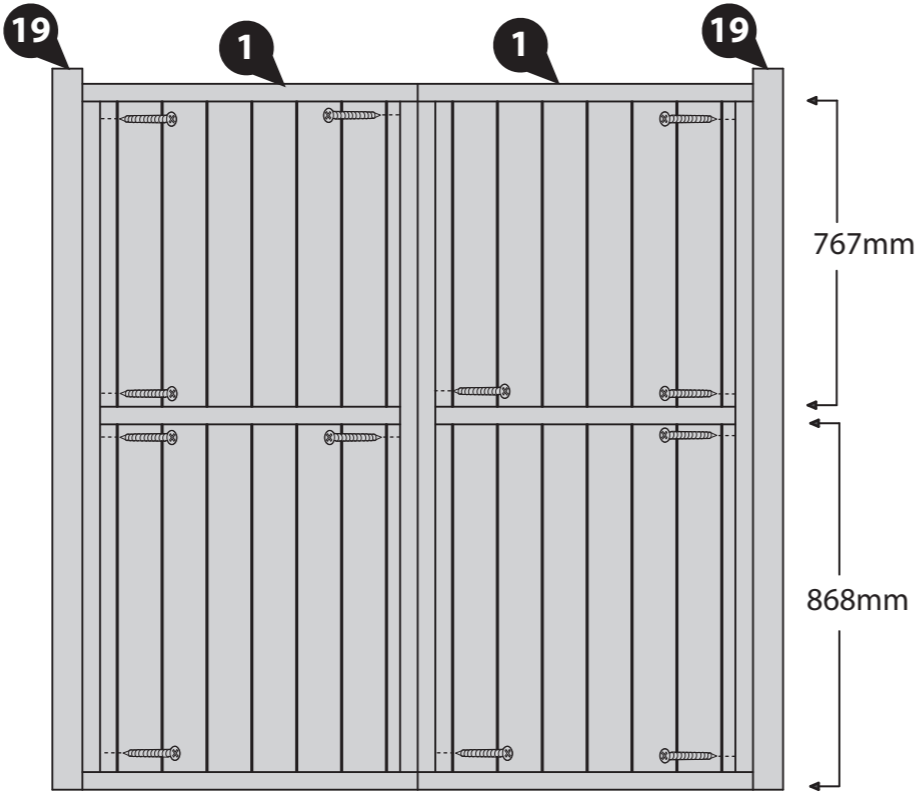

Aerial View



Extension Pack

Step 1A

Parts Needed - No. 1 QTY 3
- No. 19 QTY 2

Stand the Back Panels (No. 1) upright as shown, with the larger gap between the panel framing at the bottom, as per the measurements on the diagram. Fix together in an alternating pattern using 4x70mm screws per join.

Place Corner Posts 75x75-1800mm (No. 19) to either side flush with the inside of the panel.

Attach the post (No. 19) to the back panel (No. 1) using 4x70mm screws per post, fixing through the panel into the post.

16x70mm Screws



IMPORTANT: Pre-drill before fixing screws.

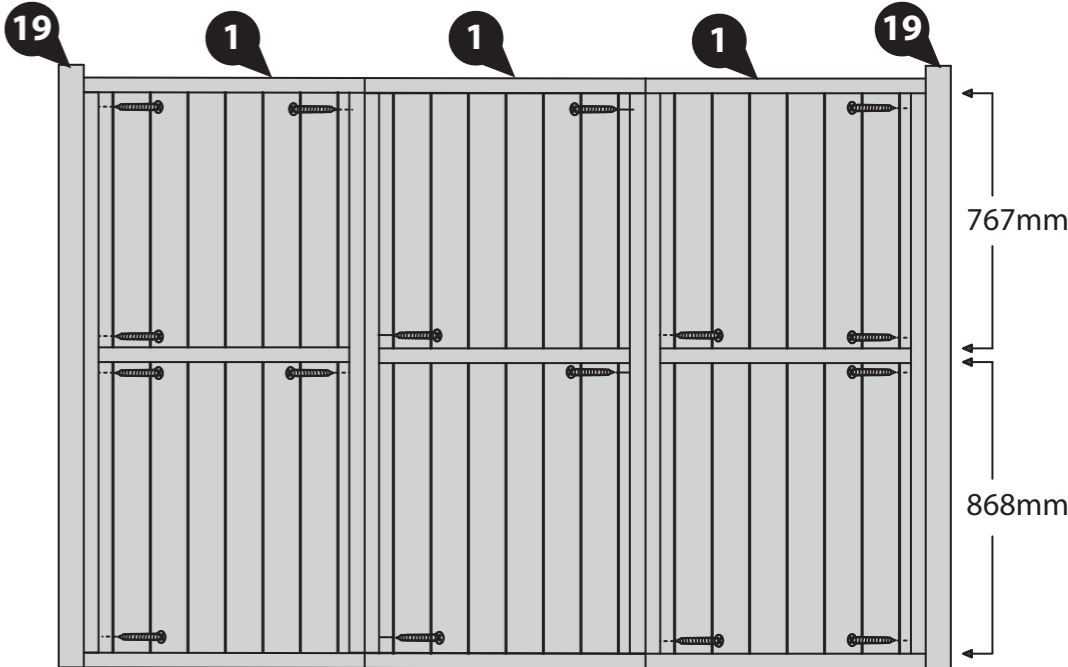

Aerial View



Step 2

Parts Needed - No. 6 QTY 2
- No. 18 QTY 2

Stand the Front Panels (No. 6) upright as shown. Fix together using 4x70mm screws in an alternating pattern.

Place the Corner Posts 75x75 - 2100mm (No. 18) at either side flush with the outside of the panels.

Attach the Corner Posts (No. 18) to the Front Panels (No. 6) using 4x70mm screws per post, fixing through the panel into the post.

12x70mm Screws

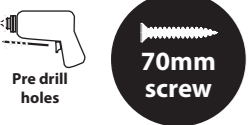

IMPORTANT: Pre-drill before fixing screws.

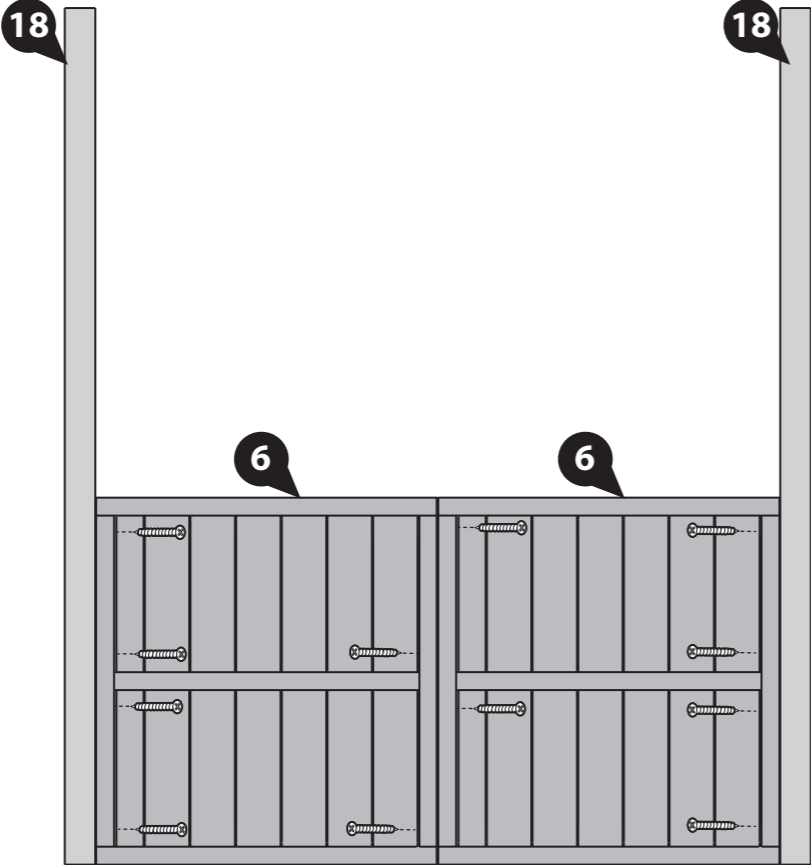

Extension Pack

Step 2A

Parts Needed - No. 6 QTY 2
- No. 18 QTY 2

Stand the Front Panels (No. 6) upright as shown. Fix together using 4x70mm screws in an alternating pattern.

Place the Corner Posts 75x75 - 2100mm (No. 18) at either side flush with the outside of the panels.

Attach the Front Posts (No. 18) to the Front Panels (No. 6) using 4x70mm screws per post, fixing through the panel into the post.

16x70mm Screws



IMPORTANT: Pre-drill before fixing screws.

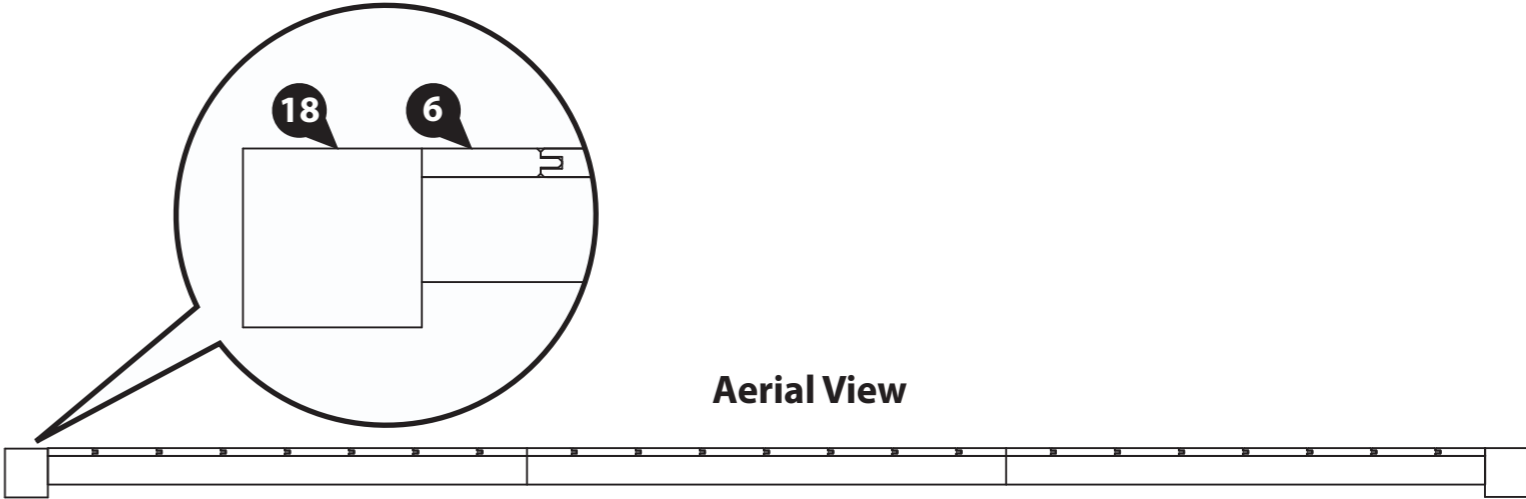
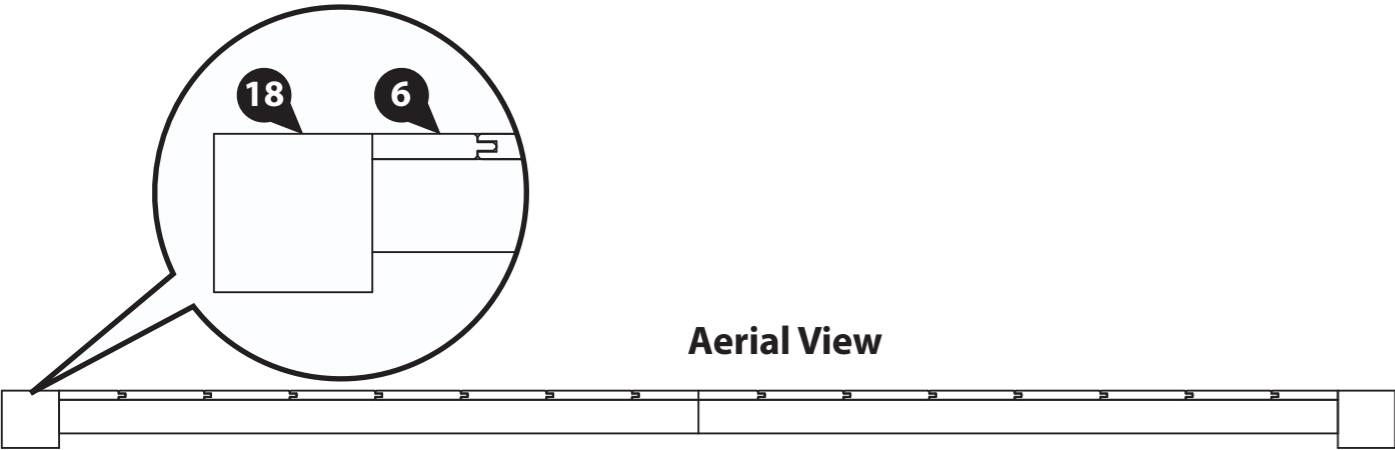
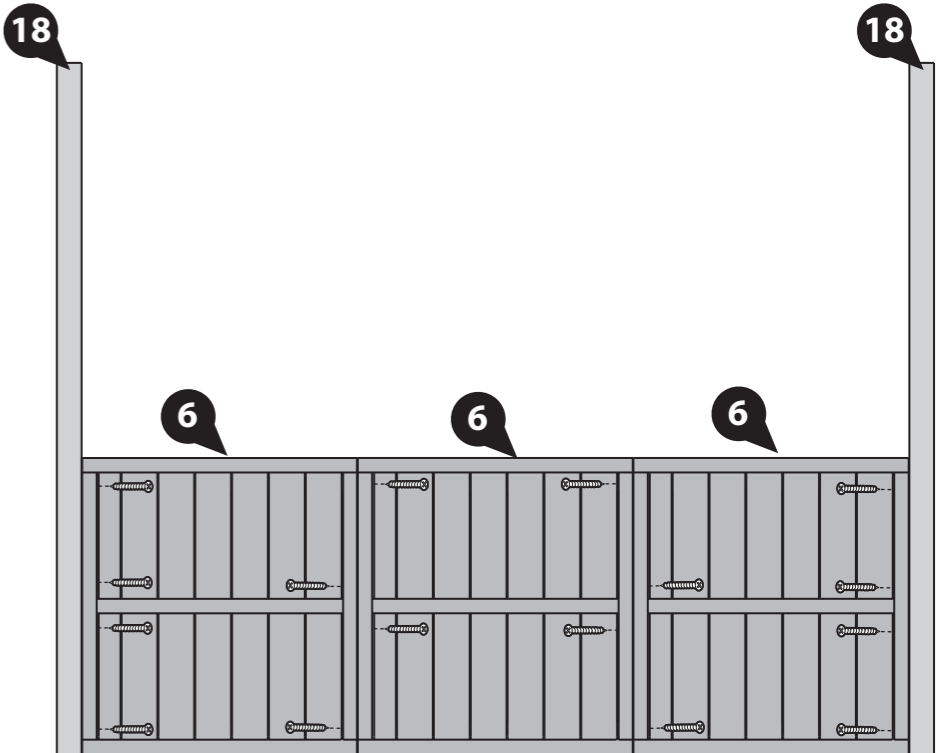

Step 3

Parts Needed - No. 3 QTY 1

Place the Left Plain Panel (No. 3) flush to the inside of the 1800mm post (No. 19).

Fix the Left Plain Panel (No. 3) to the back Post (No. 19) using 4x70mm Screws.

4x70mm Screws

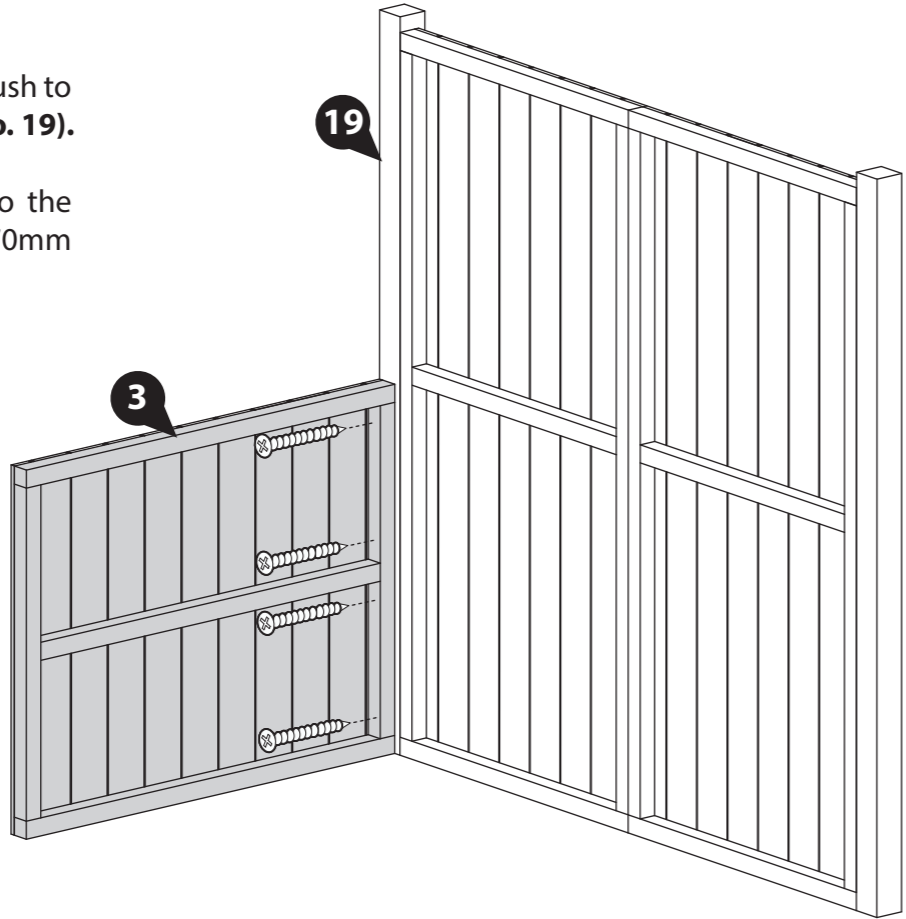
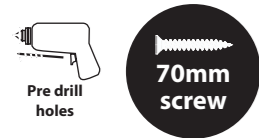

IMPORTANT: Pre-drill before fixing screws.

Step 4

Parts Needed - No. 6 QTY 2
- No. 18 QTY 2

Place the 2100mm Post (No. 18) attached to the front panels against the Left Panel (No. 3), framing facing inwards.

Ensure that the panel sits flush to the outside of the post.

Fix the Left Panel (No. 3) to the Post (No. 10) using 4x70mm screws.

4x70mm Screws

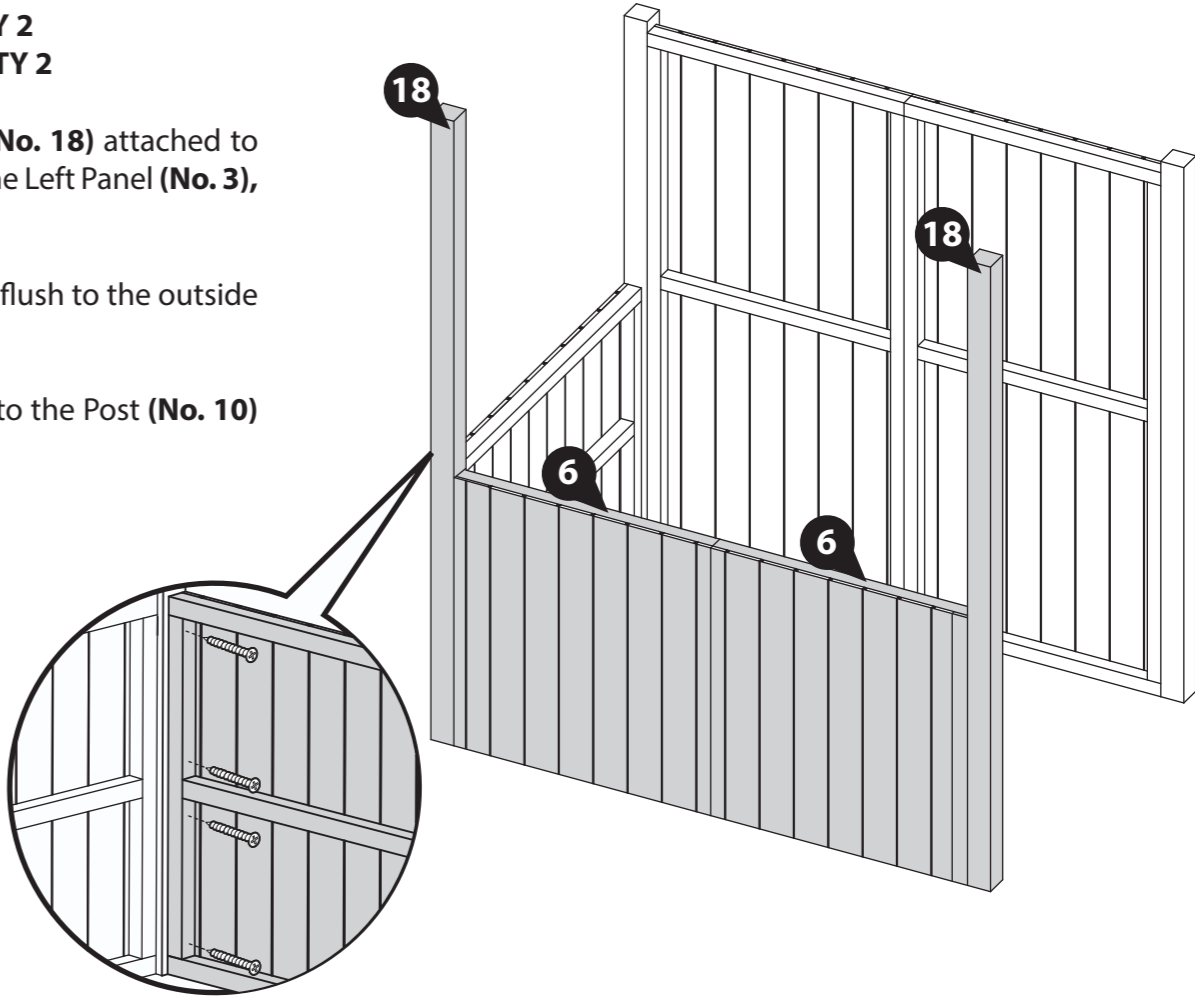
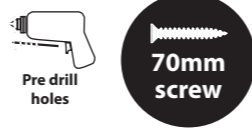

IMPORTANT: Pre-drill before fixing screws.

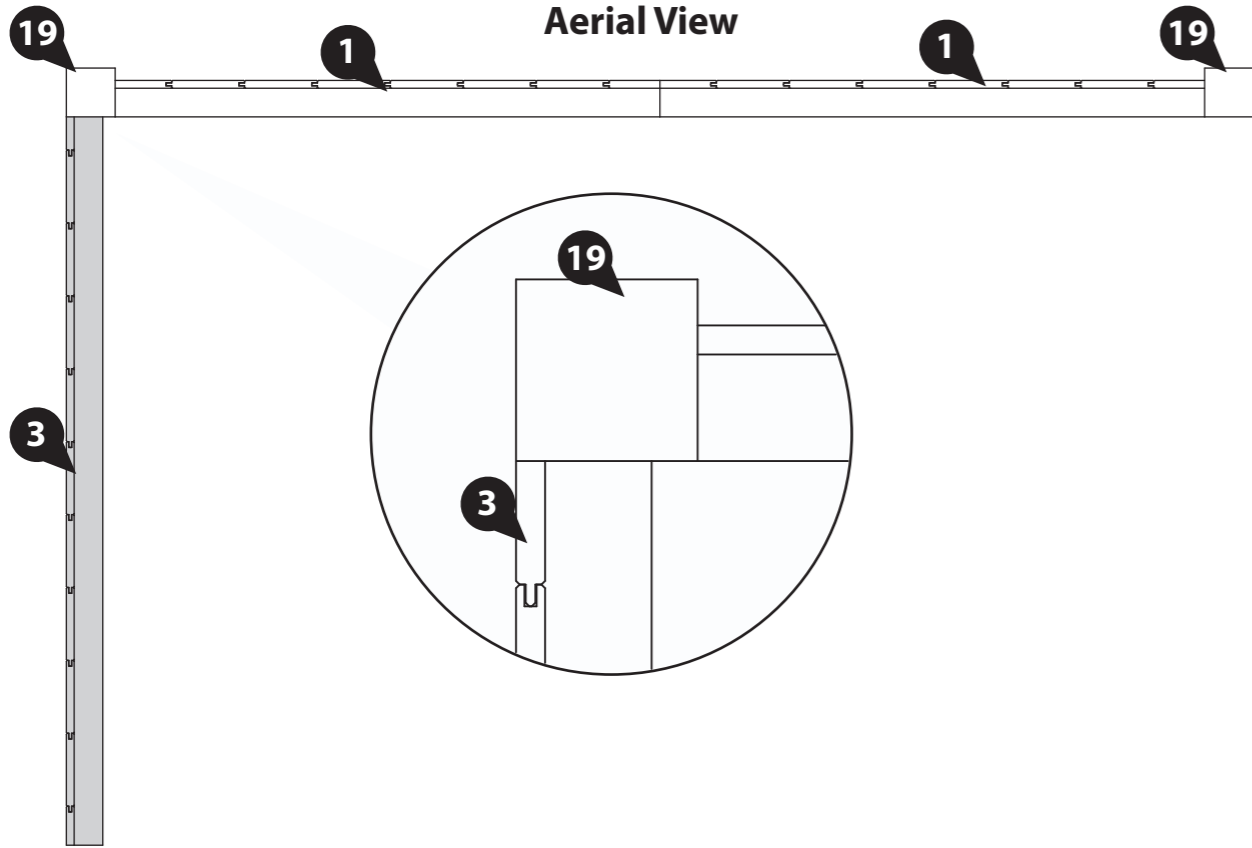

Aerial View

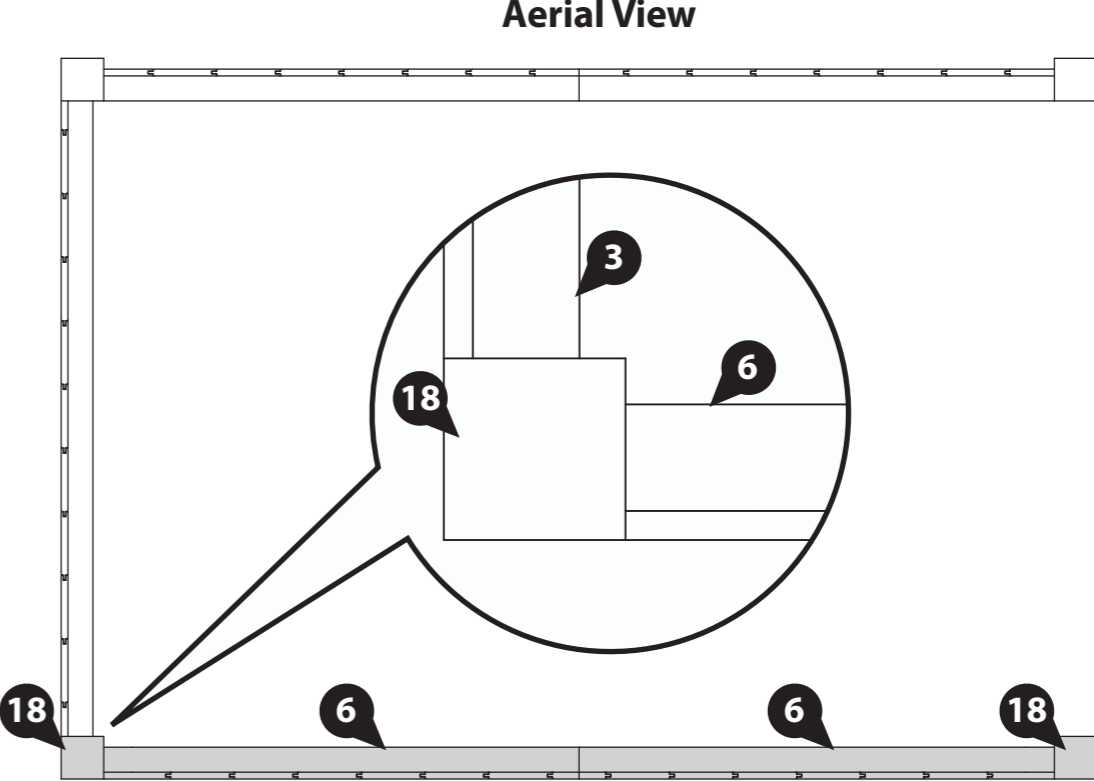

Aerial View

Step 5

Parts Needed - No. 7 QTY 1

Place the Right Plain Panel (No. 7) against the front panel Post (No. 18), with the framing facing inwards.

Ensure that the panel sits flush to the outside of the post.

Fix the Right Plain Panel (No. 7) to the Post (No. 18) using 4x70mm screws.

4x70mm Screws



70mm screw

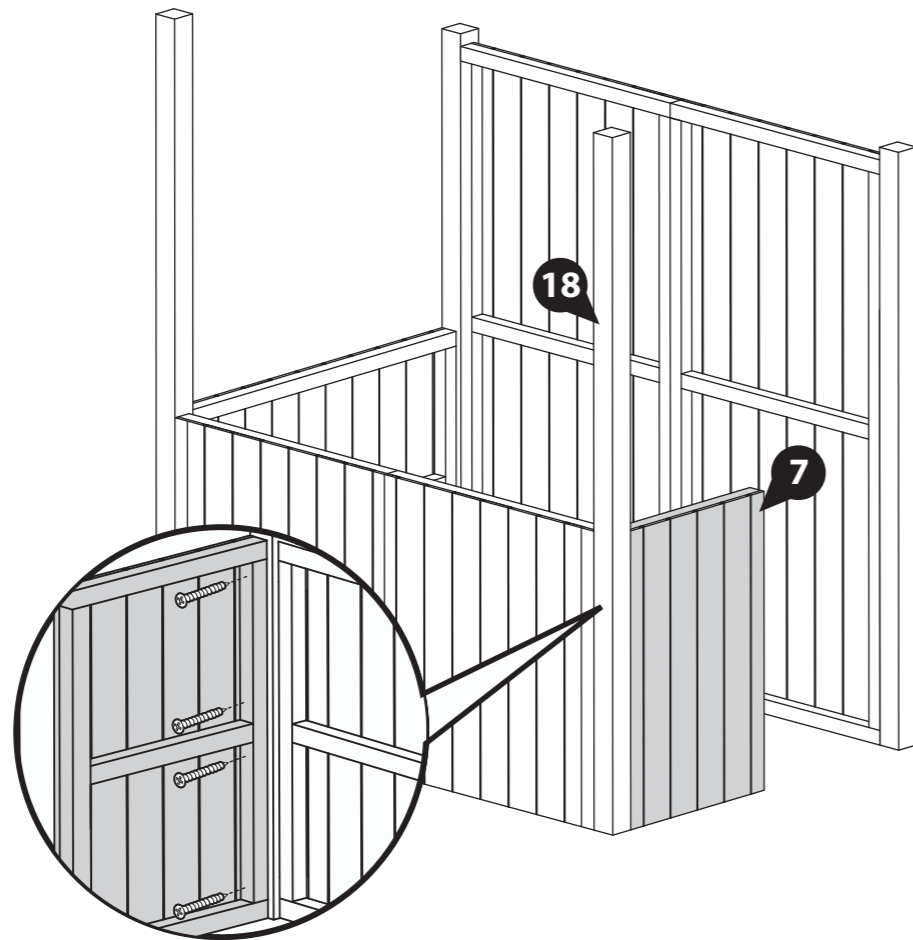

Aerial View

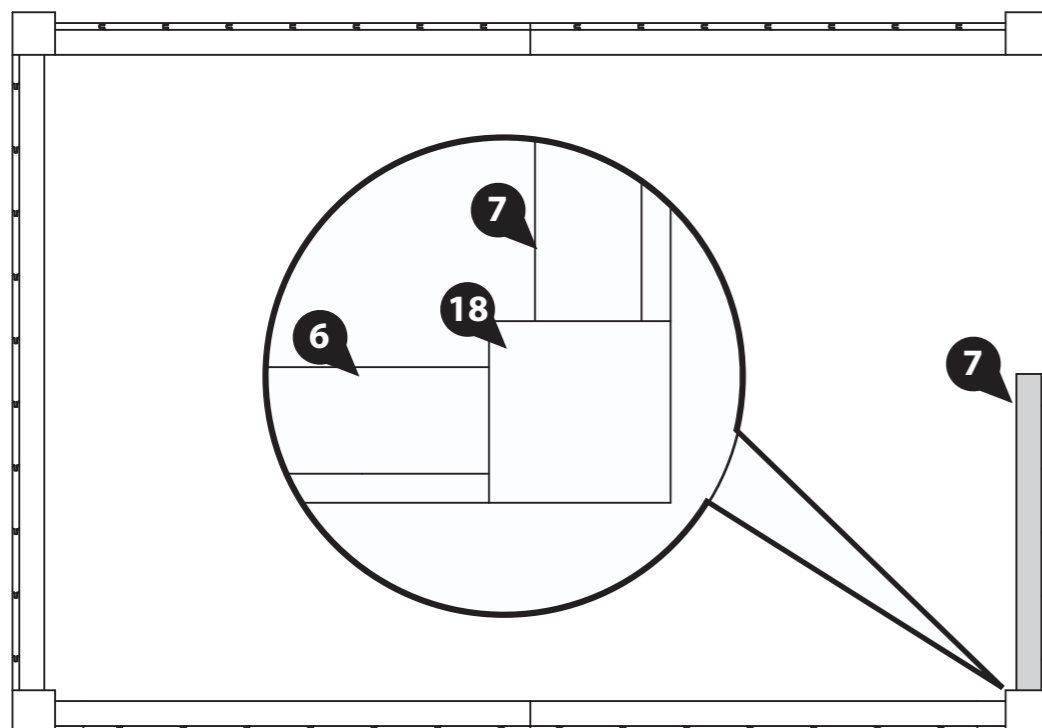

IMPORTANT: Pre-drill before fixing screws.

Step 6

Parts Needed - No. 11 QTY 1

Place the Left Bar top (No. 11) on top of the Left Plain Panel (No. 3).

Secure using 6x70mm screws going through the Bar top cladding and into the plain panel framing below.

Using 2x50mm screws, fix the Left Bar top to the back panel, ensuring that the Bar top cladding sits flush with the top of the back panel framing

2x50mm Screws

6x70mm Screws



70mm screw

50mm screw

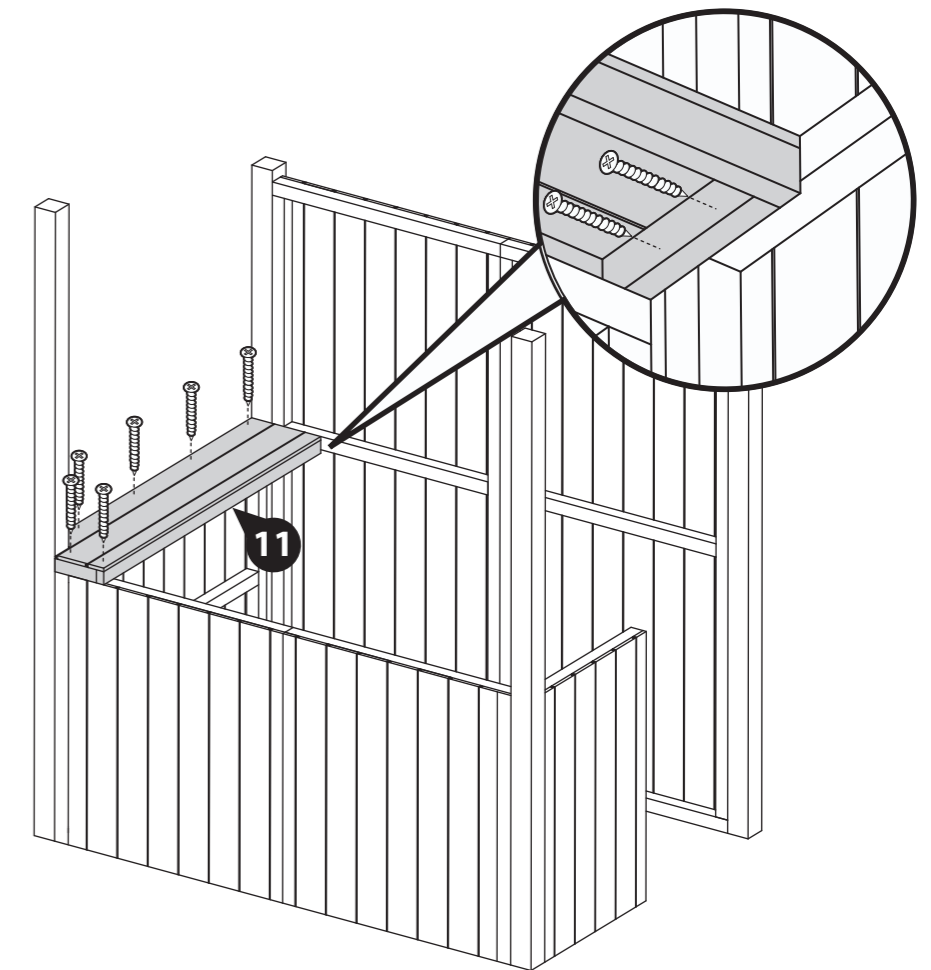

Aerial View

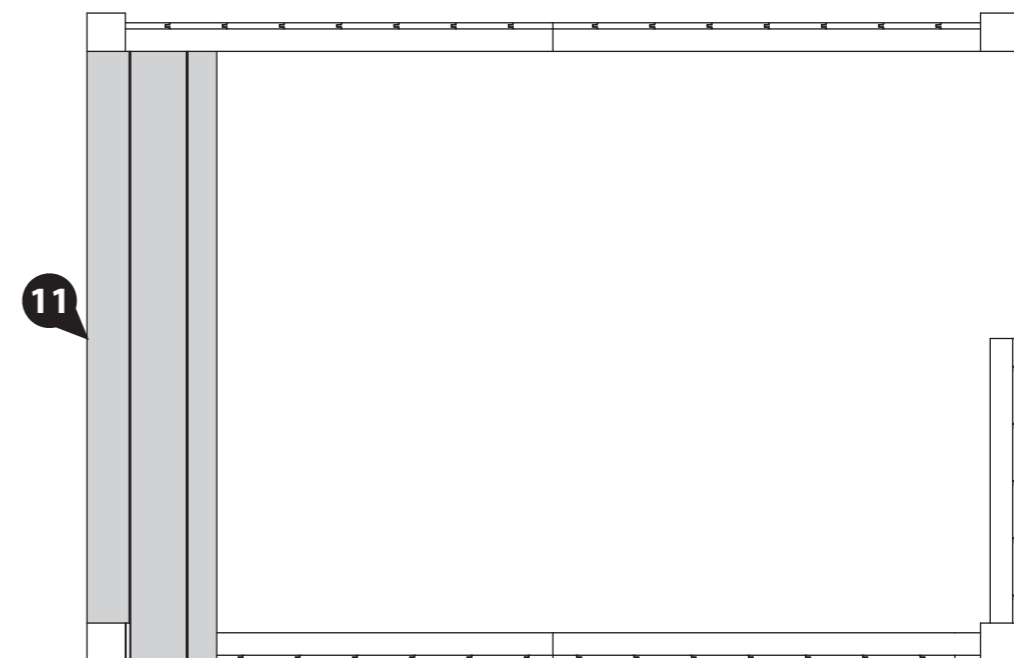

Step 7

Parts Needed - No. 10 QTY 2

Place the Plain Bar tops (No. 10) on top of the Front Panels (No. 6).

Secure using 3x70mm screws per bar top, going through the Bar top cladding and into the front panel framing below.

Using 2x50mm screws, fix the Plain Bar top to the Left Bar top from the underside of the bar tops.

Using 2x50mm screws, fix the Plain Bar tops together in alternating pattern from the underside of the bar tops

4x50mm Screws
6x70mm Screws

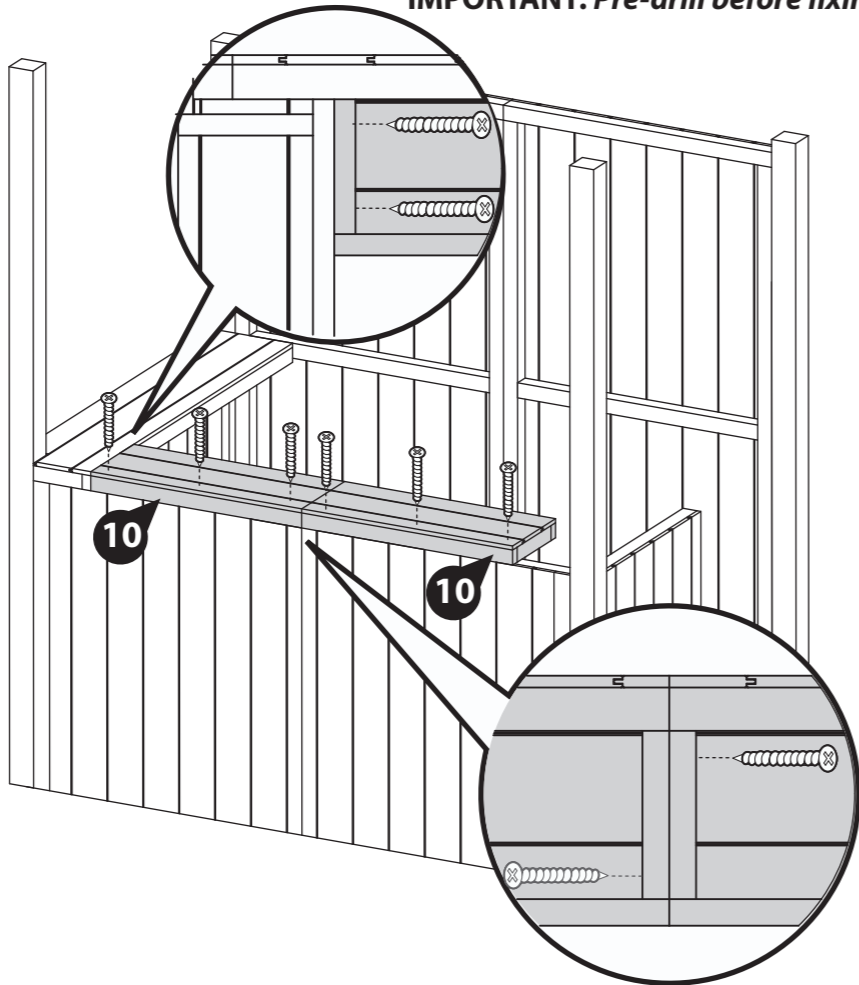

IMPORTANT: Pre-drill before fixing screws.

Extension Pack

Step 7A

Parts Needed - No. 10 QTY 2
- No. 22 QTY 1

Place the Plain Bar tops (No. 10) and the Plain Bar top Extension (No. 22) on top of the Front Panels (No. 6).

Secure using 3x70mm screws per bar top, going through the Bar top cladding and into the front panel framing below.

Using 2x50mm screws, fix the Plain Bar top to the Left Bar top from the underside of the bar tops.

Using 2x50mm screws per join, fix the Plain Bar tops and the Plain Bar top extension together in alternating pattern from the underside of the bar tops

6x50mm Screws
9x70mm Screws

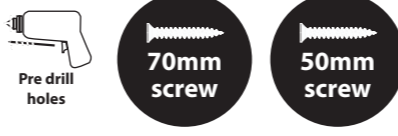

IMPORTANT: Pre-drill before fixing screws.

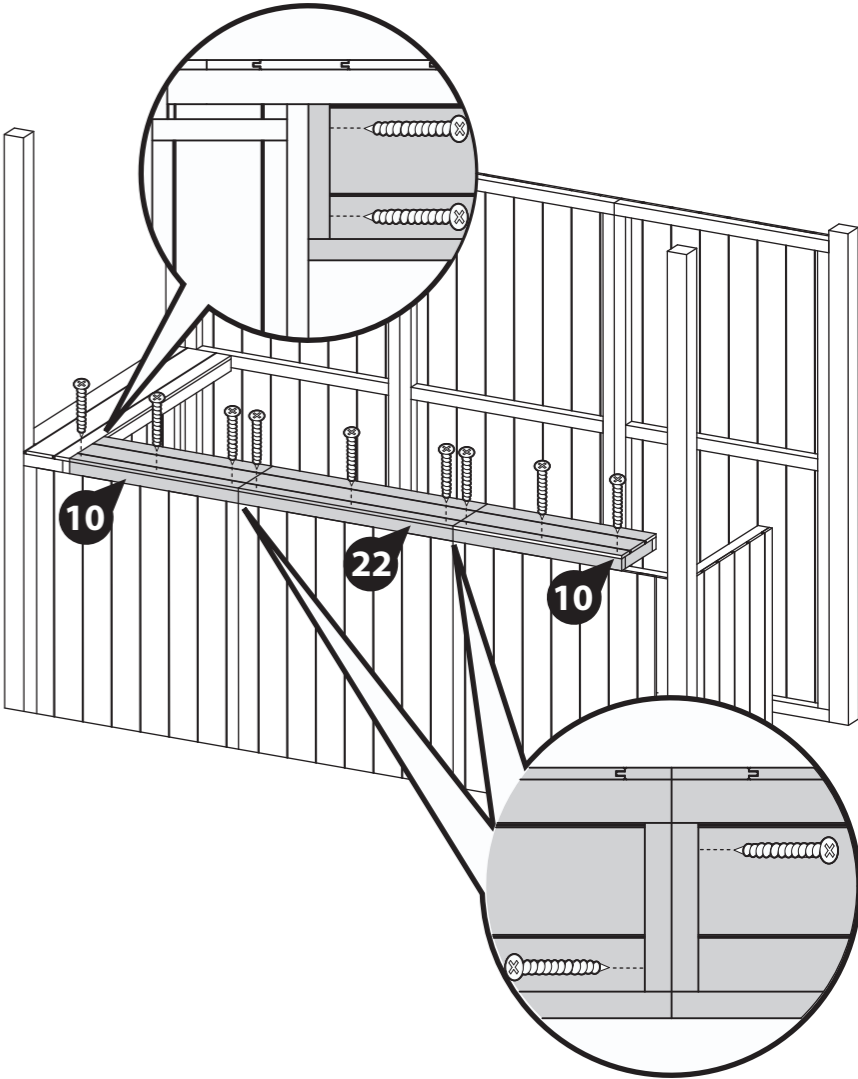

Aerial View

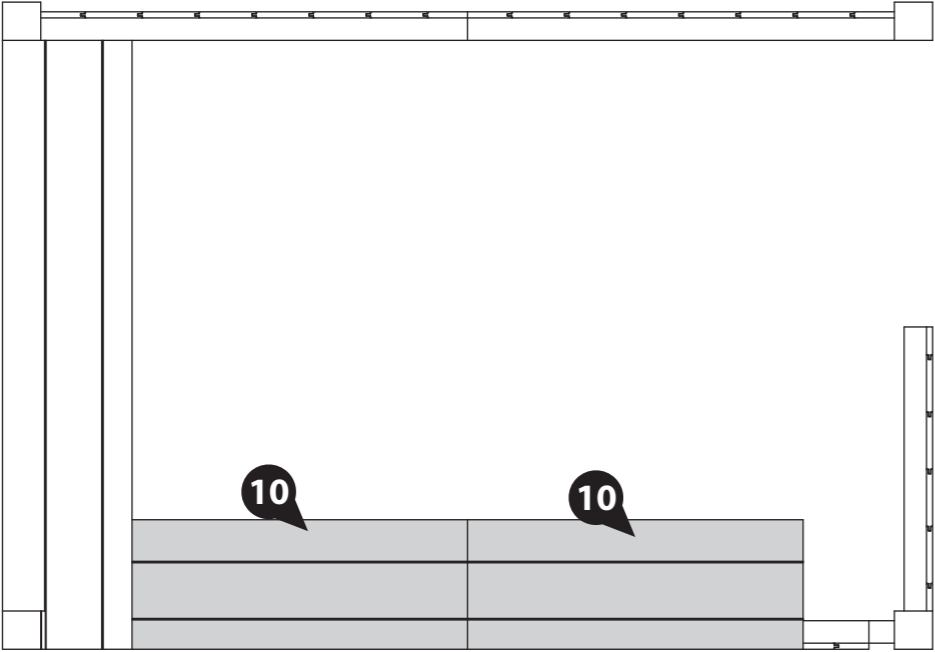

Aerial View

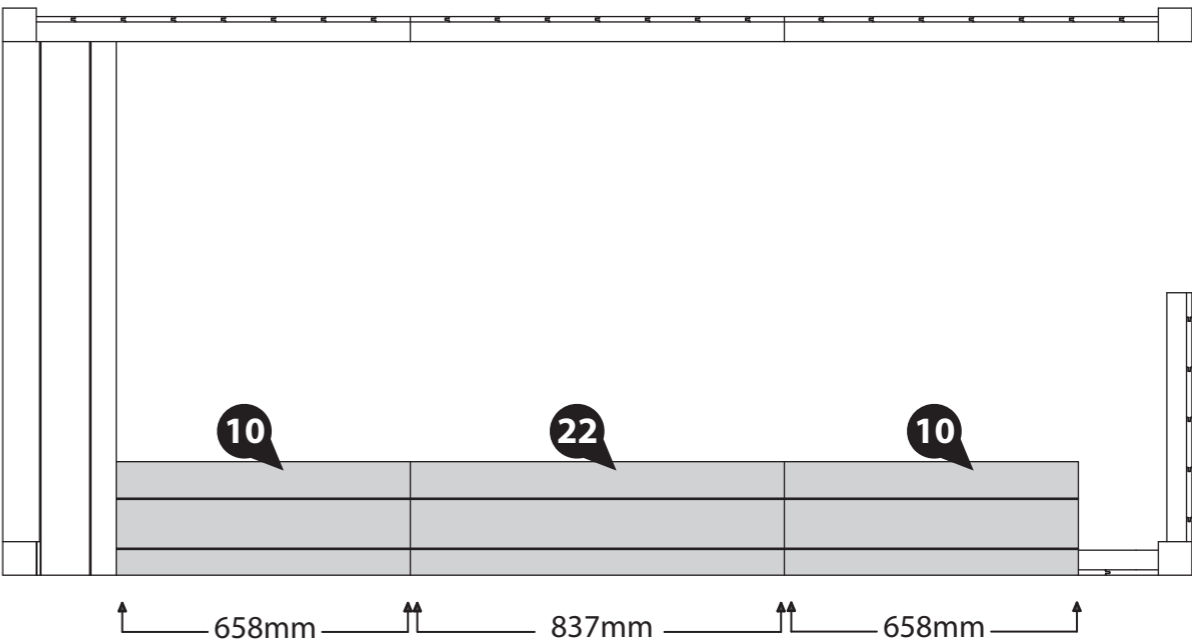

Step 8

Parts Needed - No. 9 QTY 1

Place the Right Bar top (No. 9) on top of the Right Plain Panel (No. 7).

Secure using 5x70mm screws going through the Bar top cladding and into the plain panel framing below.

Using 2x50mm screws, fix the Right Bar top to the Plain Bar top (No. 10) from the underside of the bar tops

2x50mm Screws
5x70mm Screws



IMPORTANT: Pre-drill before fixing screws.

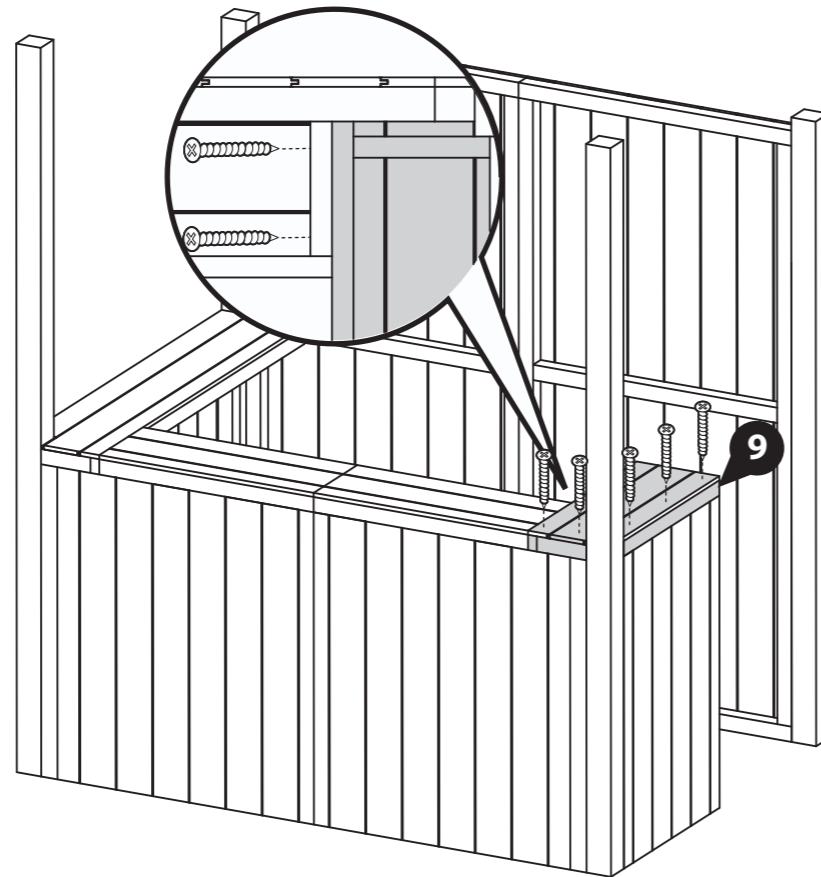

Step 9

Parts Needed - No. 20 QTY 2

Place the bar supports (No. 20) underneath the bar tops as shown in the illustration. Place the first underneath the Right Bar Top (No. 9) flush to the edge of the bar and the right plain panel (No. 7). The second should be positioned centrally between the Plain Bar Tops (No. 10) flush to the edge of the bar top and the Front Panels (No. 6).

Secure using 4x50mm screws per Bar support (No. 20) ensuring to off set the screws location so to not split the bar support.

8x50mm Screws



IMPORTANT: Pre-drill before fixing screws.

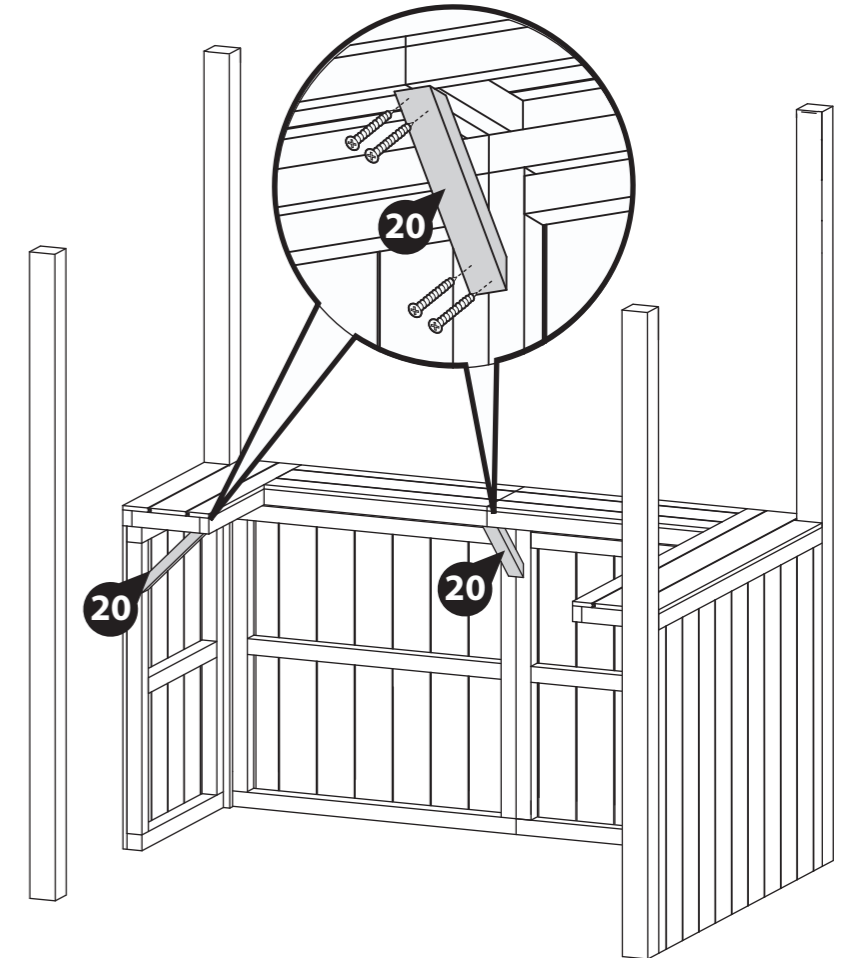

Aerial View

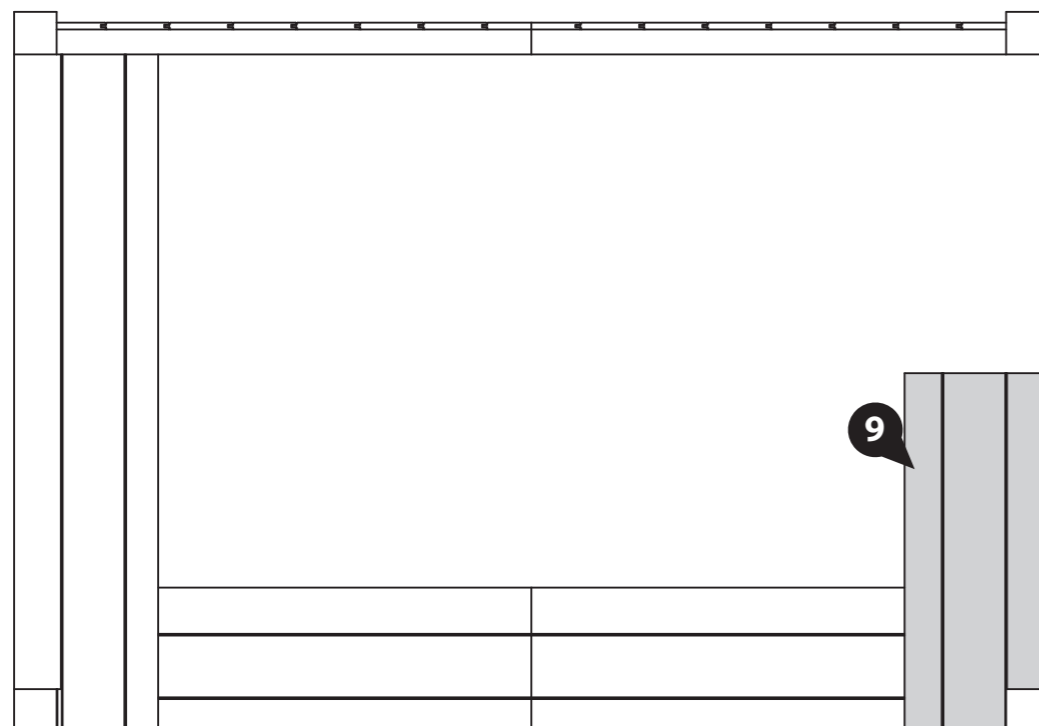

Extension Pack

Step 9A

Parts Needed - No. 20 QTY 3

Place the bar supports (No. 20) underneath the bar tops as shown in the illustration. Place the first underneath the Right Bar Top (No. 9) flush to the edge of the bar and the right plain panel (No. 7). The second and third should be positioned centrally between the Plain Bar Tops (No. 10) and the Plain Bar top Extension (No. 22), flush to the edge of the bar top and the Front Panels (No. 6).

Secure using 4x50mm screws per Bar support (No. 20) ensuring to off set the screws location so to not split the bar support.

12x50mm Screws



IMPORTANT: Pre-drill before fixing screws.

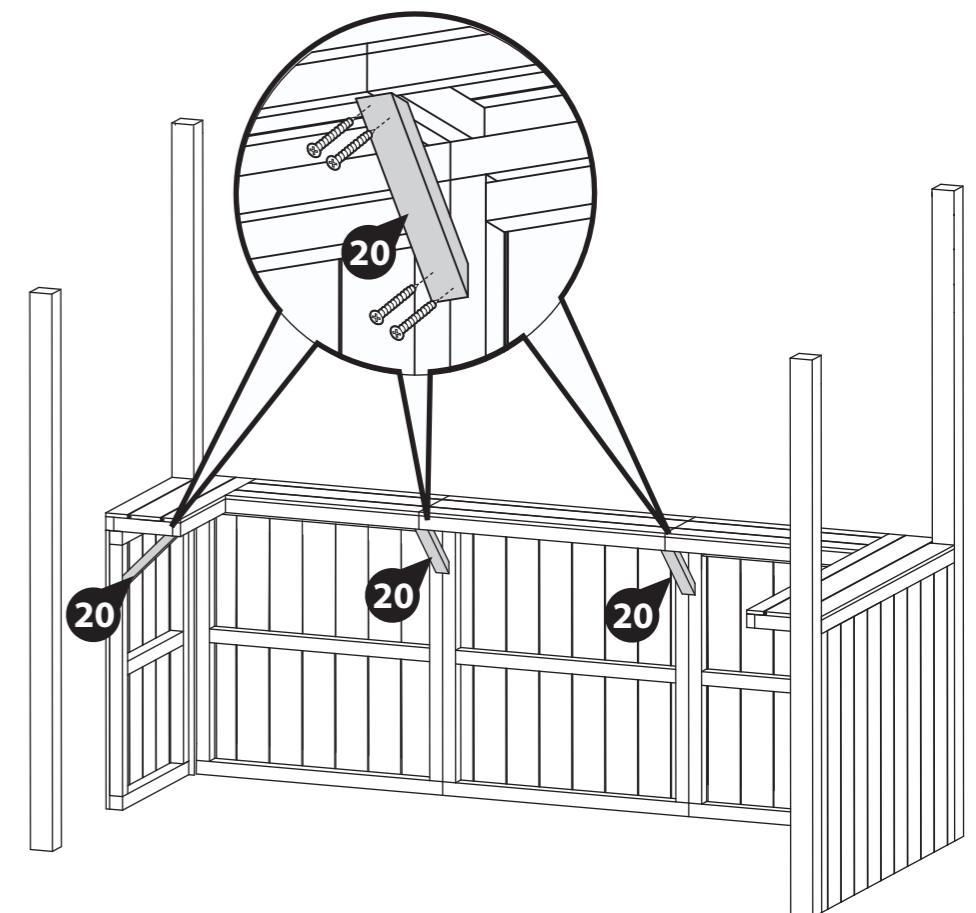

Step 10

Parts Needed - No. 4 QTY 1
- No. 5 QTY 1

Place the Right Gable (No. 4) and the Left Gable (No. 5) between the Posts, the front of the gables will sit flush to the top of the front posts. The back of the gables will sit 21mm above the back posts.

Secure each gable to the posts using 4x50mm screws. When securing to the back post, offset the screws to ensure the framing does not split

8x50mm Screws



IMPORTANT: Pre-drill before fixing screws.

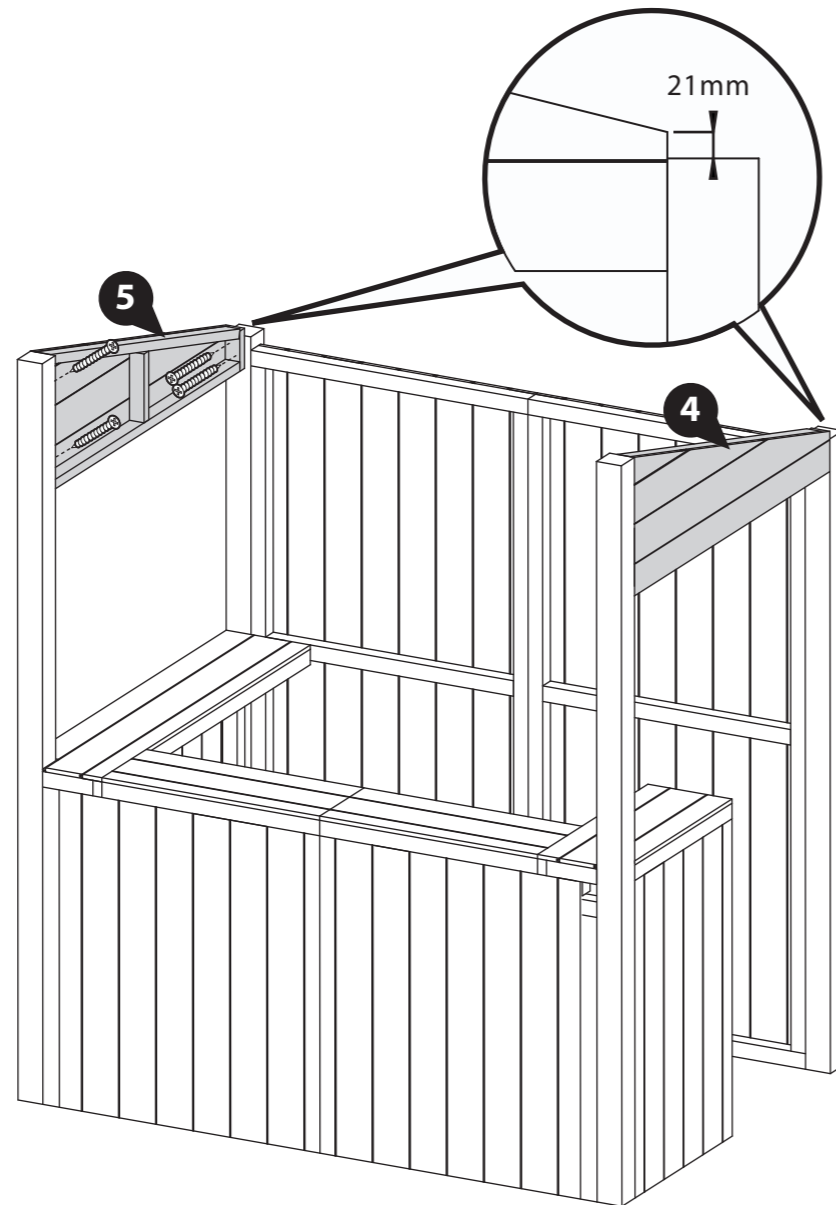

Step 11

Parts Needed - No. 8 QTY 2

Place the Top Panels (No. 8) between the front posts (No. 18), position them to be flush with the bottom of the gables.

Secure the Top panels to the Posts using 2x50mm screws.

Secure the Top panels together using 4x50mm screws in an alternating pattern.

8x50mm Screws



IMPORTANT: Pre-drill before fixing screws.

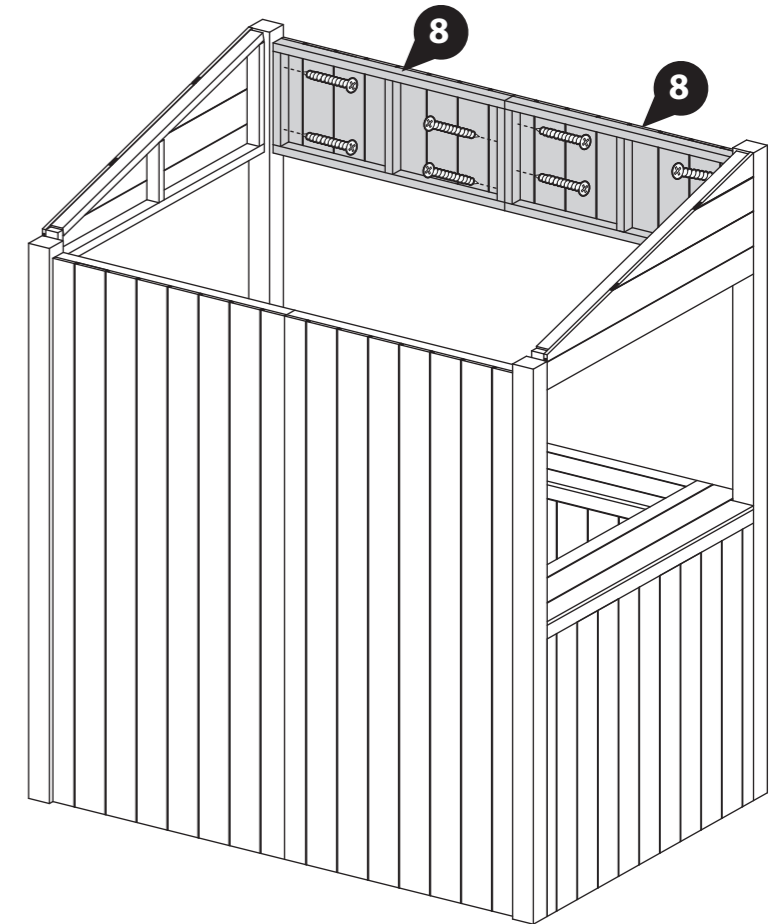

Extension Pack

Step 11A

Parts Needed - No. 8 QTY 3

Place the Top Panels (No. 8) between the the front posts (No. 20), position them to be flush with the bottom of the gables.

Secure the Top panels to the Posts using 2x50mm screws.

Secure the Top panels together using 4x50mm screws per join in an alternating pattern.

12x50mm Screws

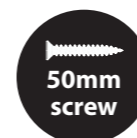

IMPORTANT: Pre-drill before fixing screws.

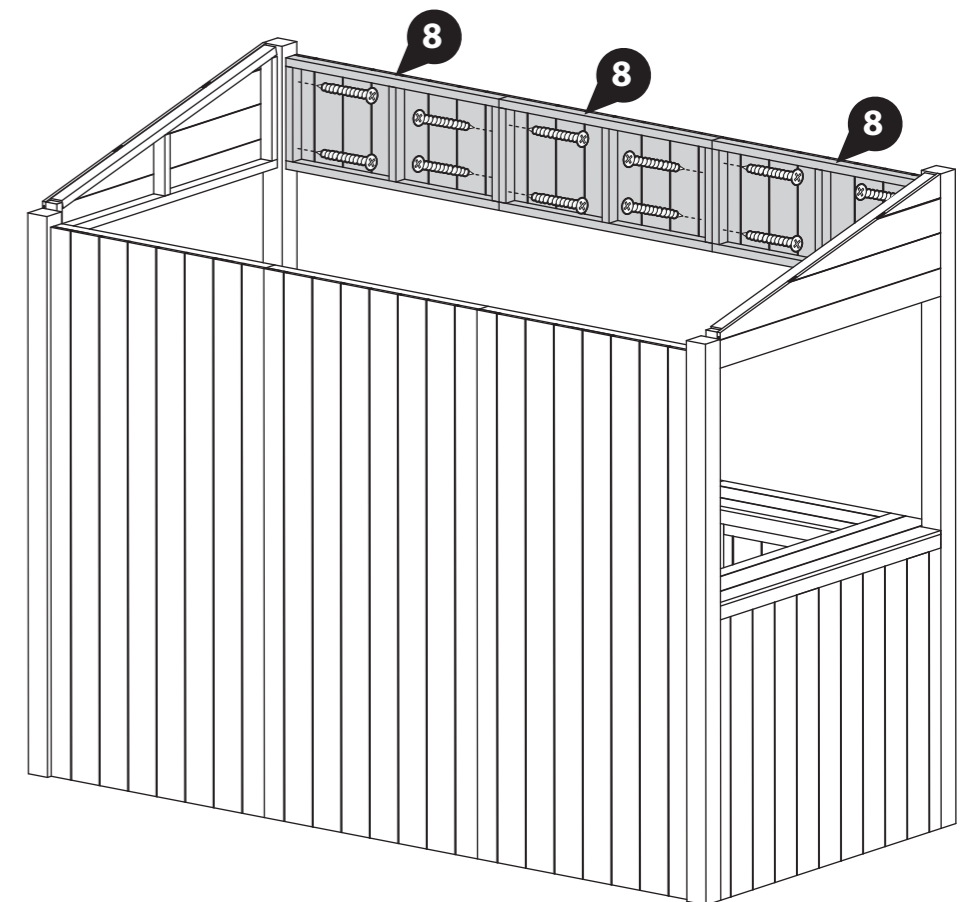

Step 12

Parts Needed - No. 2 QTY 2

Locate the Roof panels (No. 2) onto the top of the building. Use Silicone sealant along the join of the roof panels and fix together using 4x70mm Screws in an alternating pattern

4x70mm Screws

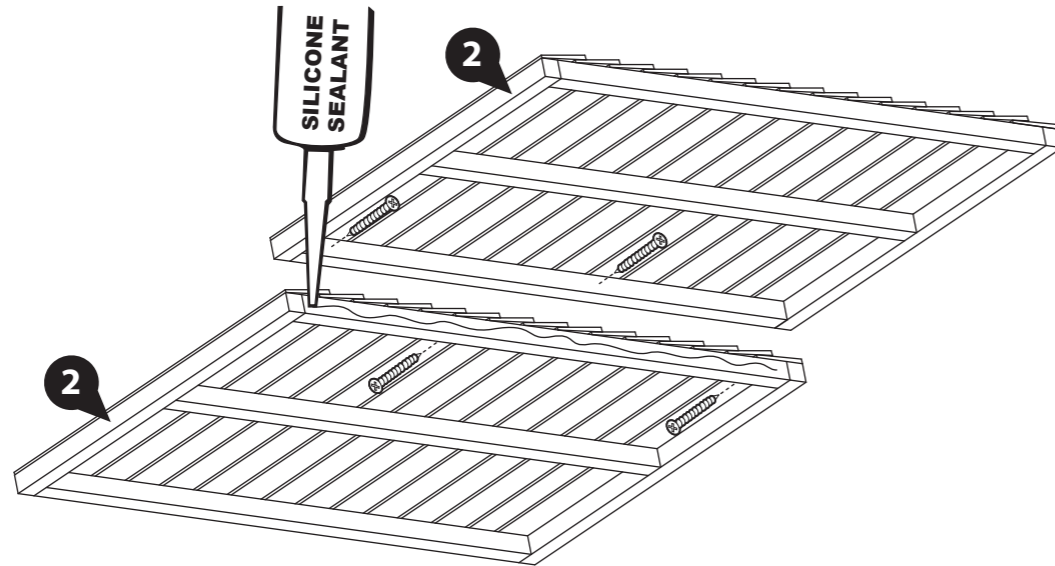

IMPORTANT: Pre-drill before fixing screws.

Step 13

Parts Needed - No. 12 QTY 1
- No. 21 QTY 2

Fix the Corner Brace (No. 21) to each end of the Ridge Bar (No. 12) using 2x30mm screws per corner brace.

Locate the Ridge bar (No. 12) to the inside of the building between the front posts, secure using 2x30mm screws per corner brace

****Tip: the ridge bar should sit flush with the underside of the roof, and flush with the top panel framing**

Fix the ridge bar to the front panels using 3x50mm screws going through the ridge bar and into the panel framing, ensuring the top panels are level

8x30mm Screws

3x50mm Screws



IMPORTANT: Pre-drill before fixing screws.

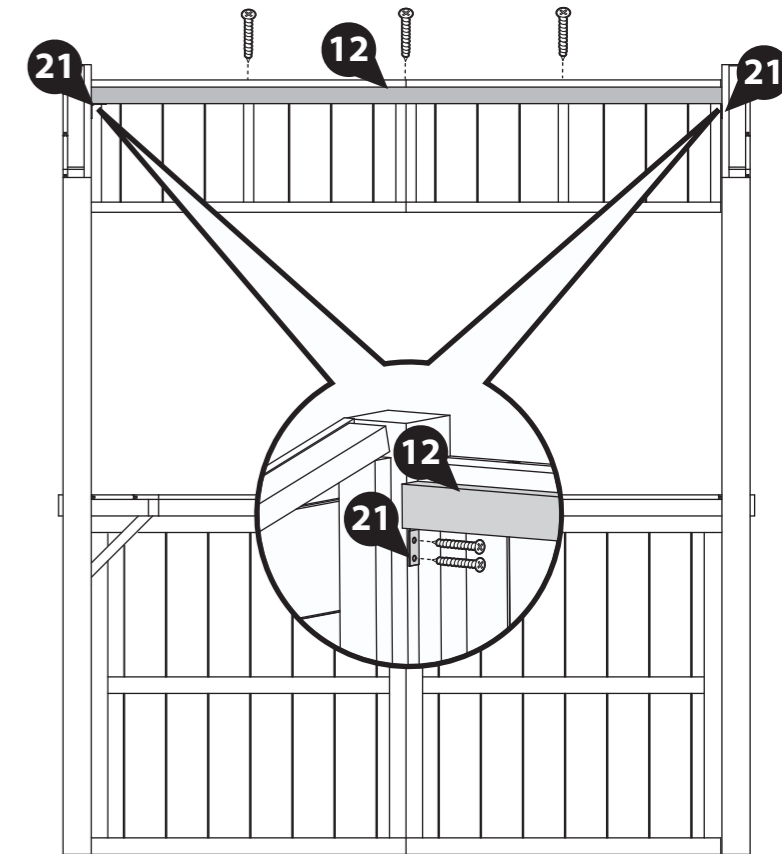

Extension Pack

Step 12A

Parts Needed - No. 2 QTY 2
- No. 23 QTY 1

Locate the Roof panels (No. 2) and the Roof Panel Extension (No. 23) onto the top of the building. Use Silicone sealant along the join of the roof panels and fix together using 4x70mm Screws per join in an alternating pattern

8x70mm Screws

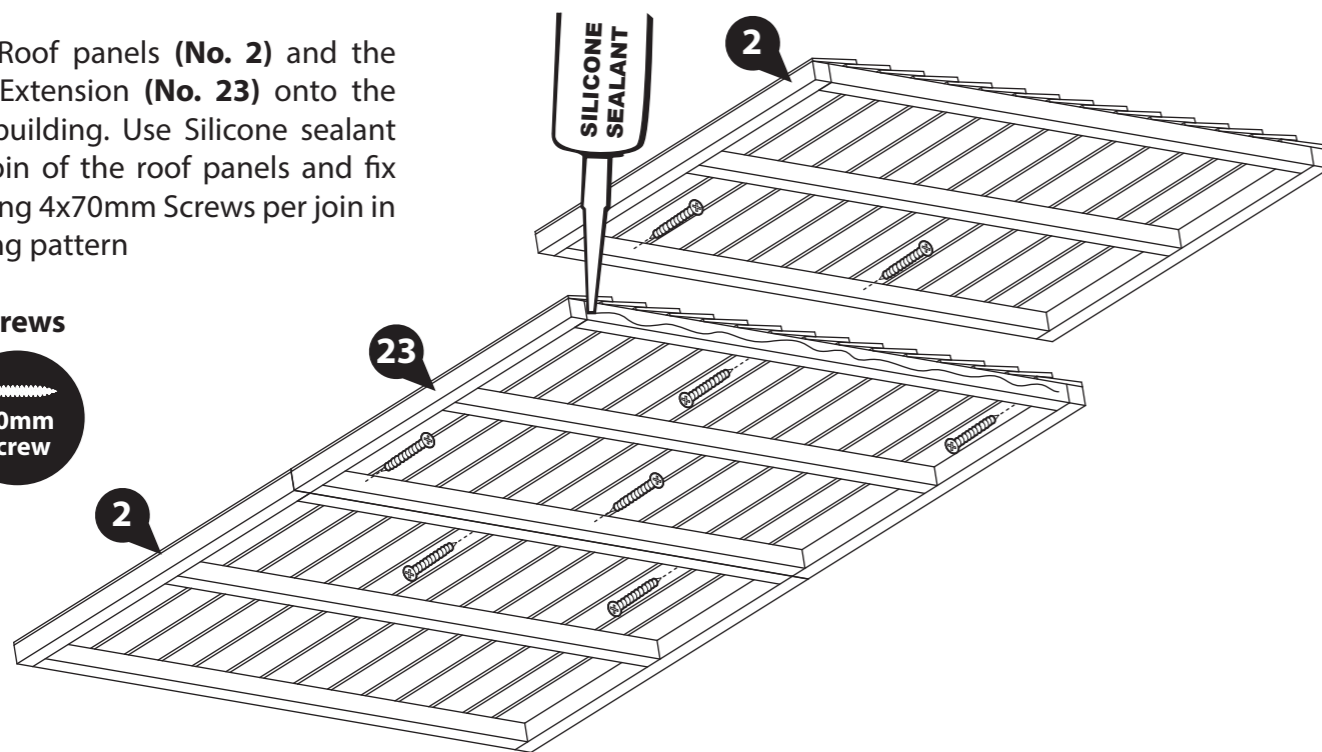

IMPORTANT: Pre-drill before fixing screws.

Extension Pack

Step 13A

Parts Needed - No. 21 QTY 1
- No. 26 QTY 1

Fix the Corner Brace (No. 21) to each end of the Ridge Bar (No. 26) using 2x30mm screws per corner brace.

Locate the Ridge bar (No. 26) to the inside of the building between the front posts, secure using 2x30mm screws per corner brace

****Tip: the ridge bar should sit flush with the underside of the roof, and flush with the top panel framing**

Fix the ridge bar to the front panels using 5x50mm screws going through the ridge bar and into the panel framing, ensuring the top panels are level

8x30mm Screws

5x50mm Screws

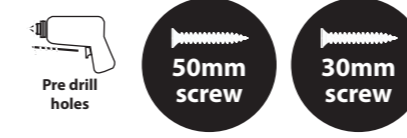

IMPORTANT: Pre-drill before fixing screws.

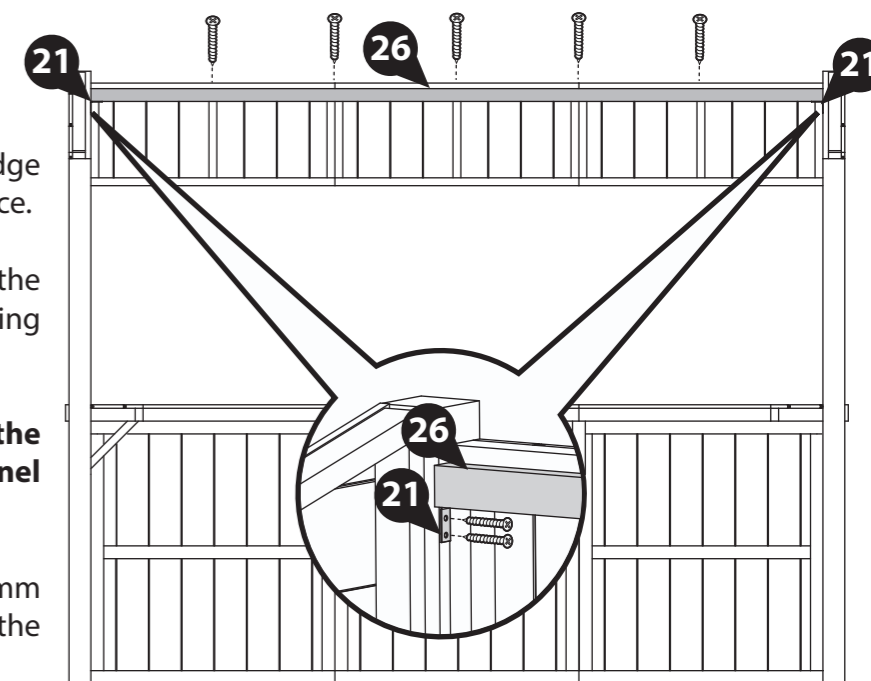

Step 14

Fix the roofs to the Building using 70mm screws, ensuring to go through into the panel framing below.

14x70mm Screws

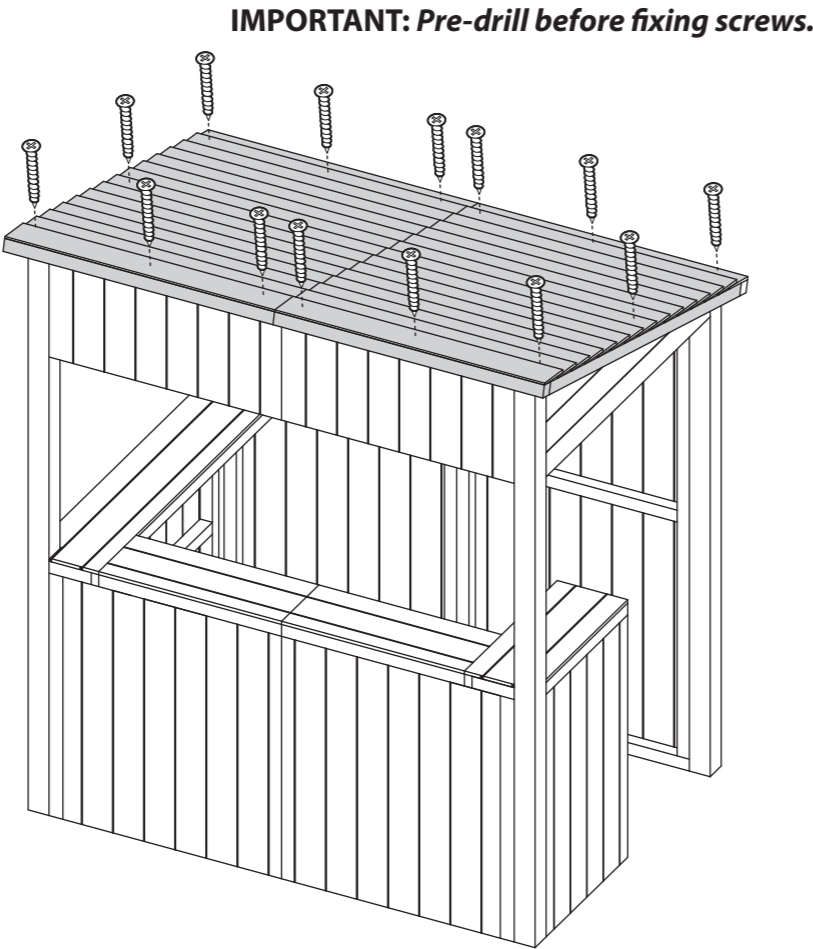
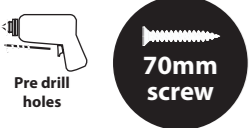

IMPORTANT: Pre-drill before fixing screws.

Step 15

Parts Needed - No. 15 QTY 1

Fix the Roof cover trim (No. 15) to the inside of the roof, equally spacing over the join in the roof, secure using 4x40mm screws in an alternating off set pattern.

4x40mm Screws

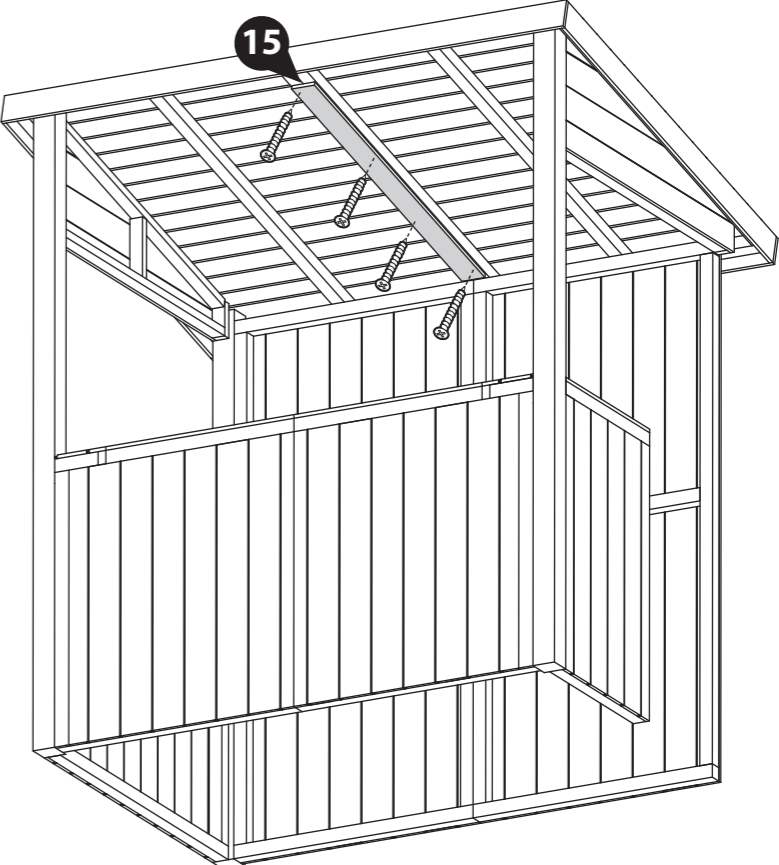

IMPORTANT: Pre-drill before fixing screws.

Extension Pack Step 14A

Fix the roofs to the Building using 70mm screws, ensuring to go through into the panel framing below.

20x70mm Screws

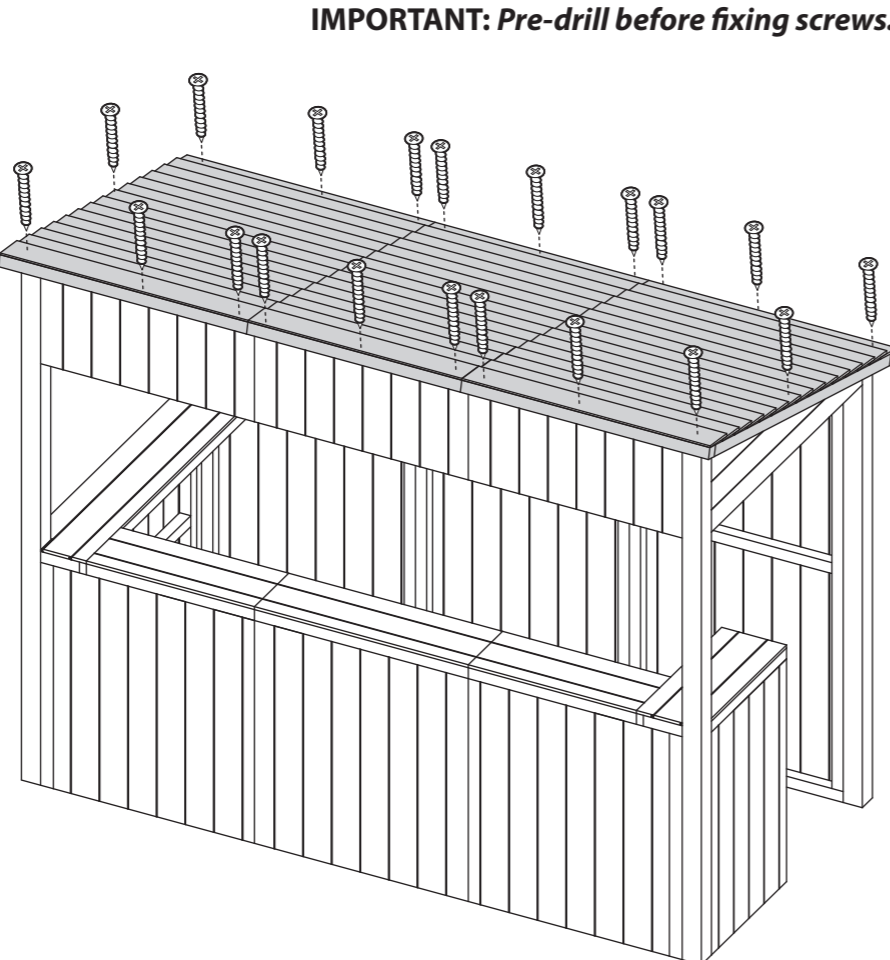
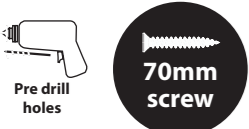

IMPORTANT: Pre-drill before fixing screws.

Extension Pack Step 15A

Parts Needed - No. 15 QTY 2

Fix the Roof cover trims (No. 15) to the inside of the roof, equally spacing over the joins in the roof, secure using 4x40mm screws per join in an alternating off set pattern.

8x40mm Screws

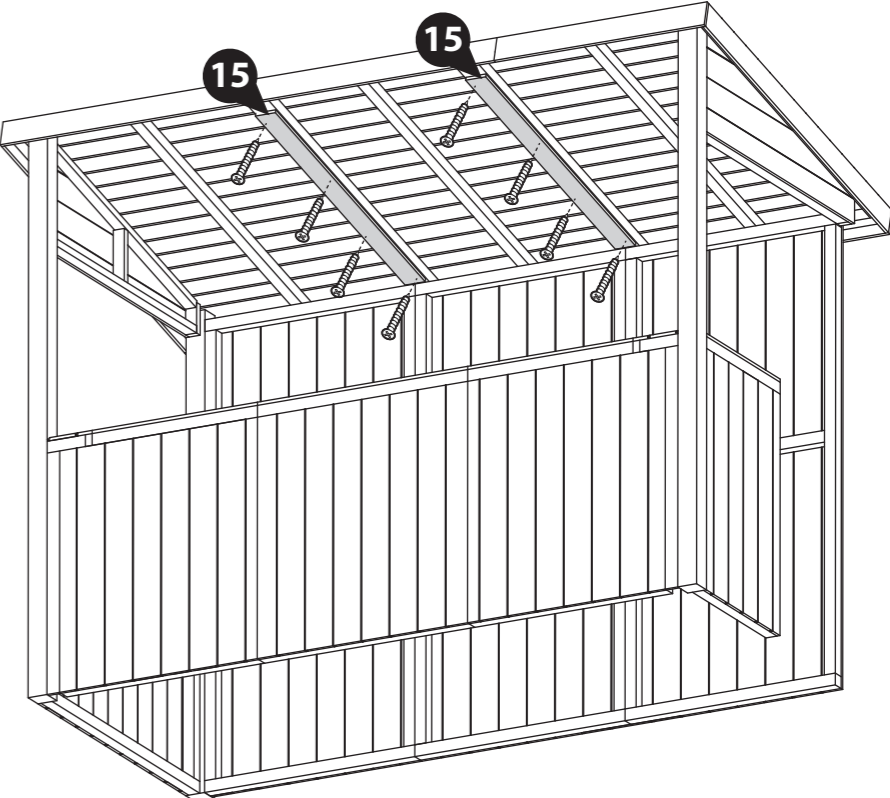

IMPORTANT: Pre-drill before fixing screws.

Step 16

Parts Needed - No. 16 QTY 2
- No. 17 QTY 2

Locate the Fascias (No. 16 and No. 17) around the sides of the roof, as shown.

Secure using 4x40mm screws for the front and back fascia (No. 16) and 3x40mm screws for the side fascias (No. 17).

14x40mm Screws

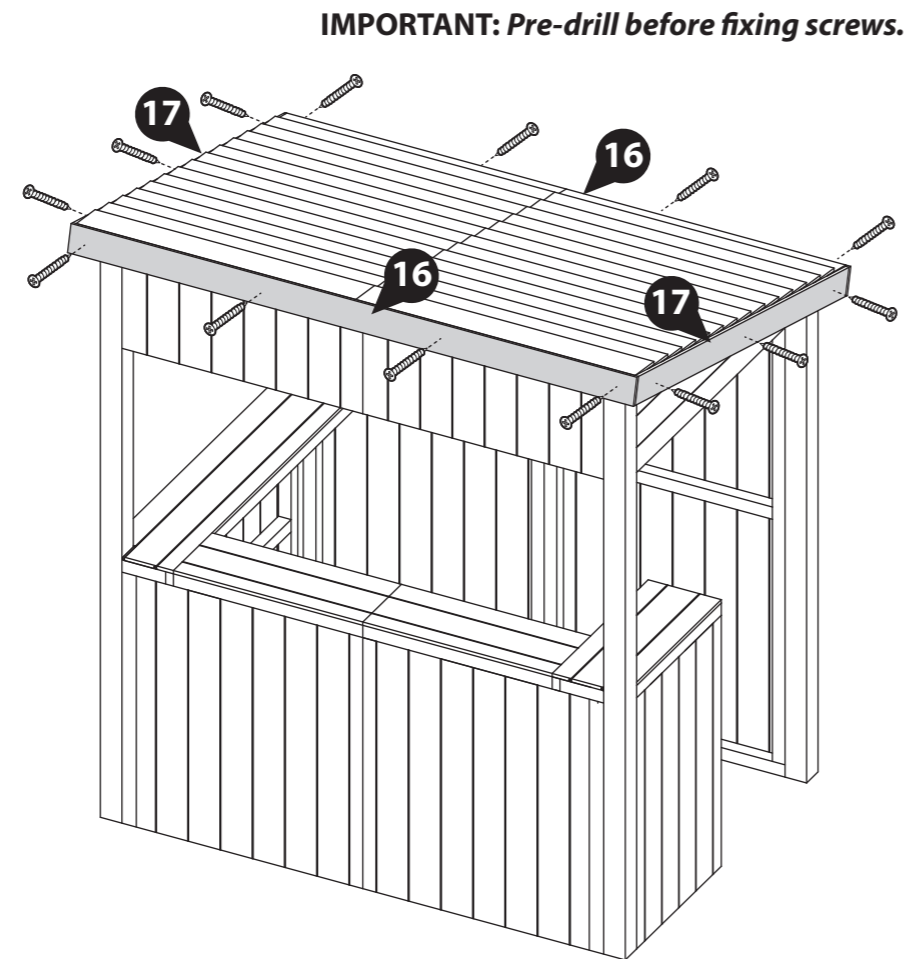

Extension Pack

Step 16A

Parts Needed - No. 16 QTY 2
- No. 17 QTY 2
- No. 25 QTY 2

Locate the Fascias (No. 16, No. 17 and No. 25) to the sides of the roof, as shown.

Secure using 4x40mm screws for the front and back fascias (No. 16), 3x40mm screws for the side fascias (No. 17) and 2x40mm for the Fascia Extensions (No. 25).

18x40mm Screws

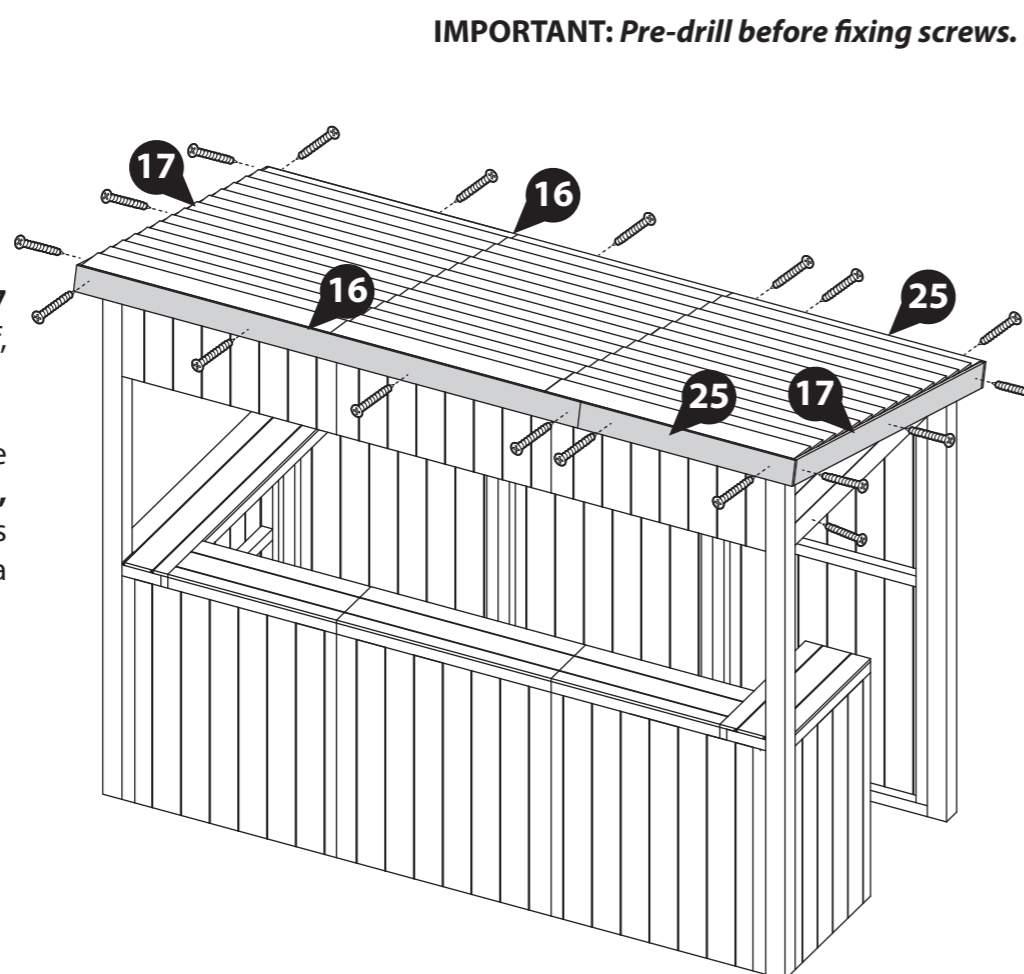

****If you have purchased a Shutter Pack, please move onto the Instructions provided with your Shutter pack.****

If not, please continue onto the next page.

Step 17

Parts Needed - No. 13 QTY 1
- No. 14 QTY 2

Fix the Cover trims (No. 13 and No. 14) to the bottom of the window openings, ensuring they sit flush to the top of the bar.

Secure using 4x40mm screws for the front Cover trim (No. 13), 3x40mm screws for the side cover trims (No. 14).

Cover trims may require cutting to size.

9x40mm Screws

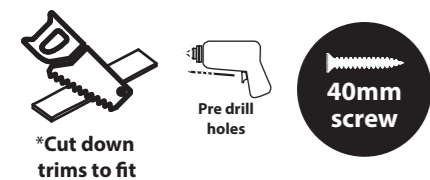

IMPORTANT: Pre-drill before fixing screws.

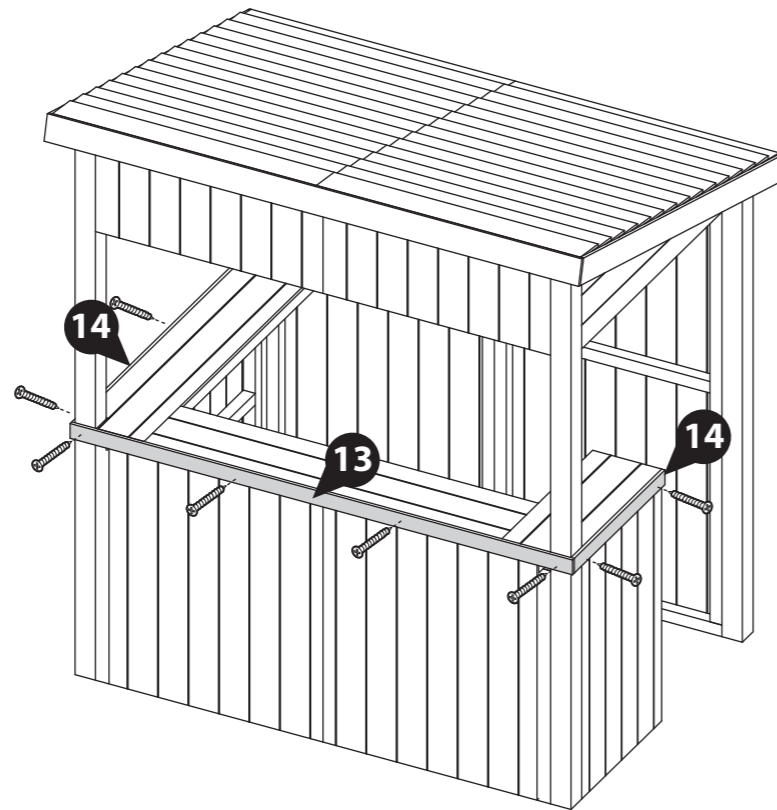

Step 18

Once constructed, apply a preserving treatment and a waterproofing treatment to your garden building as soon as possible. This will help to protect your building and prevent decay.

The roof is not leak/waterproof, however applying a preserving treatment and a waterproofing treatment will prevent leaking.

See page 16 for a full guide and instructions.



Apply treatment.

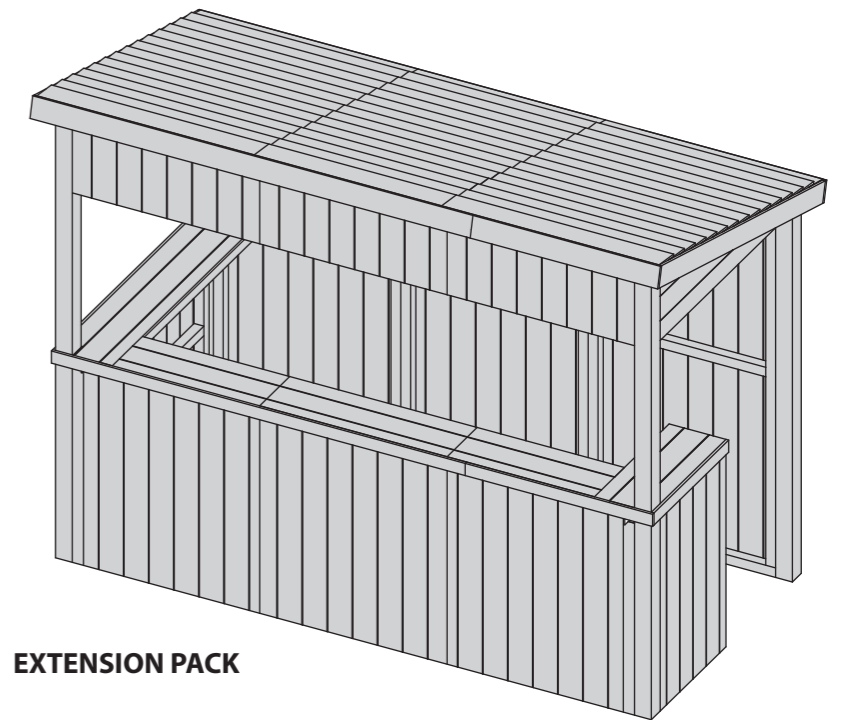
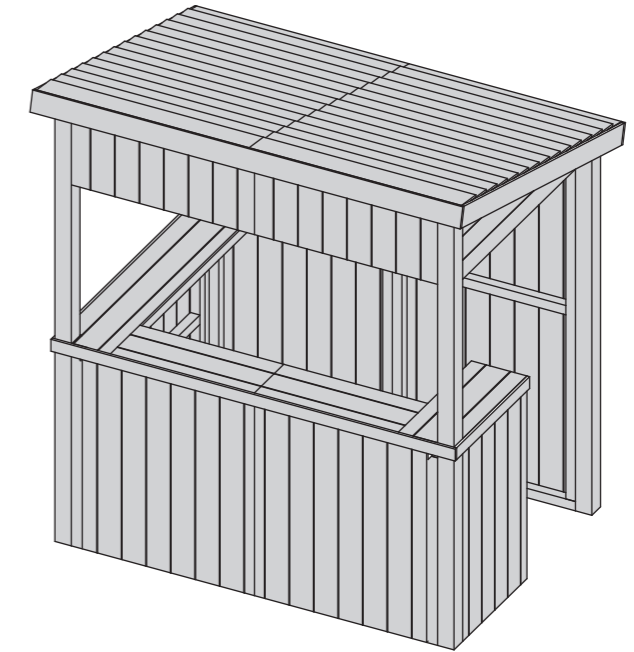

EXTENSION PACK

Extension Pack

Step 17A

Parts Needed - No. 13 QTY 1
- No. 14 QTY 1
- No. 24 QTY 1

Fix the Cover trims (No. 13, No. 14, and No. 24) to the bottom of the window openings, ensuring they sit flush to the top of the bar.

Secure using 4x40mm screws for the front Cover trim (No. 13), 3x40mm screws per side cover trims (No. 14) and the cover trim extension (No. 24).

Cover trims may require cutting to size.

12x40mm Screws

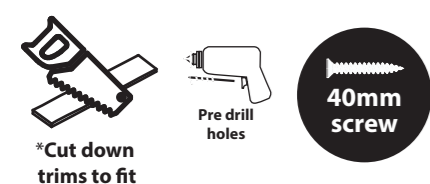

IMPORTANT: Pre-drill before fixing screws.

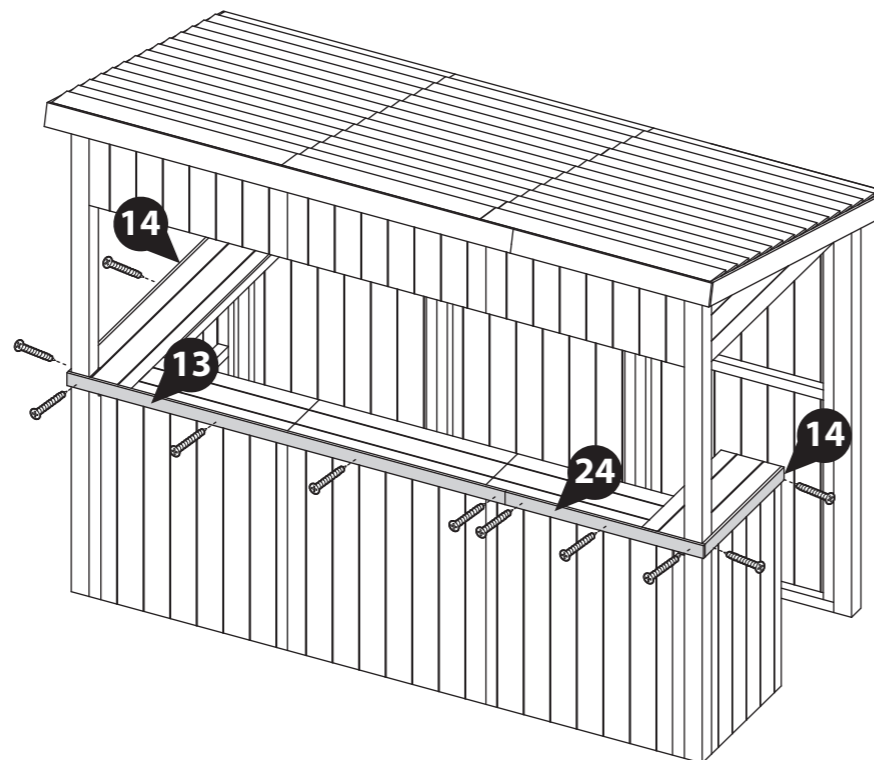

LEAVE US A REVIEW...



Want to share your experience with us?
Leave us a review on TrustPilot or Google.

Your reviews help other people find and trust our business, as well as helping to play an important role in our growth and improvement!

TREATING YOUR GARDEN BUILDING

Preservation of wood that's outdoors is vital. A little early care will help protect your garden building, improve its appearance and ensure maximum longevity. Insects, moisture, salt, and changing weather can have dramatic effects on the stability and appearance of your garden building. Once your building is installed, you've checked it over and you're happy with it, you can take a few basic precautions to prepare it for the elements. Treating your garden building helps prevent decay and, by repelling water, discourages the growth of moulds and fungi that could jeopardise the structural integrity of the wood.

Dip Treated buildings - Require a preservative treatment to protect against rot and decay and a waterproof treatment to prevent water ingress

Pressure Treated buildings - Require a waterproof treatment to prevent water ingress

Log Cabins/Insulated Garden Rooms - Are supplied untreated and require a preservative and waterproofing treatment.



ANY QUESTIONS?

Scan the QR code to contact us via our customer portal.

To apply a preservative and water proofing treatment (pressure treated products do not require a preserver), follow the manufacturer's instructions but in principle, stick to the following steps:

- ✓ Weather permitting, ensure to treat your garden building within 14 days of installation.
- ✓ Wear latex or rubber gloves, eye protection and (if spraying) a mask.
- ✓ Prepare the wood, by sanding down any ridges or inconsistencies in the wood, smoothing out knots and end-cuts.
- ✓ Choose a dry day to treat your garden building. If you're spraying rather than brushing paint on, avoid a windy day.
- ✓ Be sure you can safely reach all the sections you need to paint - and if you need a ladder, make sure it's safely positioned before climbing. Lay dust sheets around to avoid paint splatters on your base or surrounding plants.

- ✓ Tape around windowpanes to avoid smears when you're painting the frames.
- ✓ Keep pets and small children out of the way. The last thing you want is to have fur on your garden building paint, or little painted footprints all over your garden and home.
- ✓ Fill any gaps in the building's body with caulk or wood filler to prevent water and draughts getting in. Silicone based caulk is flexible and will move with the timber when temperature and humidity change. Allow to dry completely before treating. A handy tip for finding gaps is to go into your garden building and look for light leaking through joins and frames. If light gets in, then so will water.
- ✓ Liberally apply at least two coats of the treatment products with a brush or spray, taking care to allow the first coat to completely dry before applying the second.
- ✓ Make sure the solution permeates the whole of the surface area, especially around natural cracks, end cuts and nail/screw holes.



APPLY WOOD TREATMENT
IMMEDIATELY
AFTER ASSEMBLY



1 Perimeter

Check around the perimeter of your product to ensure there are not trees or plants that are in contact with or overhanging the building. This can affect airflow and overhanging trees, or branches can damage the roof, it is advised to keep plants at a distance.

2 Repair

Inspect the interior and exterior of the product to look for splits, cracks, and holes. Although this is a natural occurrence it can be prevented. A wood filler can be used to close the splits, cracks, and holes.

3 Roof

Check your roof regularly for tears, splits, damaged wood and fallen debris. If you notice any of this immediate repair is critical.

4 Doors & Windows

Expansion and contraction can cause doors and windows to stick or become difficult to open. Small adjustments to the hinge position can be made to the doors and windows to allow free movement.

5 Oil

Hinges can seize up over time, apply lubricant to the hinges and locks annually.

6 Screws & Bolts

It is advised to check all screws and bolts and tighten any loose you might find. For log cabins specifically the storm braces will require loosening. During humidity and temperature changes (seasons) to allow expansion and contraction to prevent gaping, twisting, popping, and warping.

7 Wash

At least once a year, give the outside of you building a good wash, to remove cobwebs, leaves, or any other dirt that may accumulate on the exterior.

8 Airing

Airing your product regularly prevents the build up of condensation which can cause the timber to warp, bow, boards to pop, distortion, rot and mould. Condensation can build up over time or daily, it is caused by a rise and fall in temperature.

Excessive moisture levels within your building can cause water to collect on the roofs, walls and floors internally. Leaving doors and windows open regularly can help combat the natural moisture build up.

9 Clean & Tidy

It is good practice to clean the inside and outside of your product regularly. Clear out the contents, sweep the floor, remove dirt and cobwebs. Check for areas of damp and investigate the cause to remove and prevent future occurrences. Check the ground around your product for build up of debris such as leaves, remove and ensure there is clear ventilation underneath the floor.

Additional Playhouse Maintenance:

It is recommended that the following checks and maintenance are carried out at the beginning of each season as well as at regular intervals during the usage season.

- Check all nuts /bolts/ screws for tightness and tighten when required.
- Check for movement / opening of wood giving rise to protrusion of nail heads and tips.
- Check hinges.
- Replace defective parts in accordance with the manufacturers instructions.
- Check any crossbeams, suspensions and anchors.
- If a swing is included; check the swing seat, chains and ropes.

IF THESE CHECKS ARE NOT CARRIED OUT THE ACTIVITY TOY COULD BECOME A HAZARD

All our garden buildings have been designed and manufactured with care and attention to be the perfect addition to your outdoor space. To ensure you do get the best out of your new garden building and to increase the longevity we advise that you follow the product instructions and our manufacturer's recommendations as detailed below. Thank you for choosing a Mercia Garden product!

1 Choosing the most suitable location for your garden building...

A minimum of 60cm should be left around the perimeter of your garden building to allow access for maintenance, annual treatment and to allow air flow around the building.

Where possible you should avoid placing your garden building underneath large trees to prevent the tree causing damage to the building.

2 Preparing the base for your garden building...

All our buildings must be built on a firm, level base to ensure the longevity of the building and prevent the wood from distorting. We recommend either concrete, concrete slabs or a wooden base, such as our 'Portabase'.

The base should be slightly smaller than the external measurement of the building, i.e. the cladding should overlap the base, creating a run off for water and preventing water from pooling underneath the building.

We also recommend that the floor of the garden building is a minimum of 25mm above the surrounding ground level to avoid flooding.

3 After installation...

Once your garden building has been installed, it will need to be treated within 14 days (weather permitting) and annually to prevent the timber from deteriorating and to waterproof it. This is required to maintain the anti-rot guarantee.

Dip Treated buildings - Require a preservative treatment to protect against rot and decay and a waterproof treatment to prevent water ingress.

Pressure Treated buildings - Require a waterproof treatment to prevent water ingress.

Log Cabins/Insulated Garden Rooms - Are supplied untreated and require a preservative and waterproofing treatment.

We also recommend using a silicon sealant on the inside and outside of the windows as soon as possible after assembly and treatment to fully seal the windows.

Roofing felt/covering should be checked annually and replaced or fixed accordingly.

4 General maintenance and wood characteristics

As wood is a natural material it may be affected by the following:

Shrinkage and warping - The timber used in the construction of your garden building will have retained some of its natural moisture content. The moisture content of the timber will vary, depending upon prevailing environmental conditions, which will result in the components either naturally expanding or contracting. As the components dry out, shrinkage may occur. A good waterproofing treatment from the start is the best protection to minimise the effect of moisture loss/intake.

In extended periods of very warm weather getting some moisture to the building will help the overall balance. You can do this by spraying it down lightly with a garden hose. In contrast, after snow fall try to remove the snow as best as possible from the roof to prevent moisture intake and to remove the extra weight.

Top tip - using a garden brush will help you to reach the highest part of the building to remove snow and any debris left from bad weather.

Damp and mould - During the winter months, cold and damp conditions can result in an increased amount of moisture within your garden building, especially when used infrequently. Condensation can form on the timber and other items stored within your garden building. If left this moisture is likely to cause mould and mildew.

To prevent the build-up of moisture, we recommend leaving the door or windows of your building open from time to time, to allow the fresh air to circulate. We also advise against storing wet or damp items in your garden building as this will also increase the level of moisture in the building. If mould or mildew does start to form within your building we recommend using an anti-mould cleaner to remove it and to prevent it spreading, which if left untreated could permanently damage your garden building.

Splits, cracks and knots - You may notice small splits and cracks in some components or holes may appear where knots shrink and fall out. This will not affect the structure of your Garden building however, if you wish to fill them this can be easily done using any good quality wood filler.

Sap - is naturally occurring in wood and may appear in some boards of your garden building. If you wish to remove the sap, we advise waiting until it is dry and then using a sharp knife to carefully remove it. If the removal of the sap causes a hole in the timber, we recommend using a good quality wood filler to fill it.

For more handy hints and tips on how to care and maintain your garden building please refer to the MGP Customer Portal at www.mgplogistics.co.uk

Any further questions?



Contact our Customer Service Team via the MGP Customer Portal at: www.mgplogistics.co.uk

1

Manufacturer's Warranty

All Mercia Garden Products are supplied with a 1 year warranty on all parts against manufacturing defects.

This warranty does not cover movement, warping or splitting of timber products over time.

This warranty will be voided if any of the following occur:

1. The building has been customised or modified/adapted in any way.
2. The person claiming is not the original purchaser of the building.
3. Any damage has been caused by or as a result of misuse.
4. The building has not been maintained and cared for in accordance to our advisories and manufacturer's recommendations.
5. The building has not been treated annually or as per the manufacturer's recommendations, please ensure receipts are kept to validate this claim.
6. The building has not been erected, fitted or installed as per the supplier instructions.
7. The building has not been erected on a suitable sized firm flat, solid level concrete/slab base or placed on pressure treated bearers.
8. The building is or has been placed with 2 feet (600mm) of any obstructions (walls, trees, plants, fences etc.) which can allow moisture to penetrate the timber.
9. The roofing felt has been incorrectly fitted or damaged, allowing water ingress, or has not been properly maintained.
10. Any windows and joints have not been sealed, inside and out, with silicone or other watertight sealant.
11. Any timber has been cut, pierced or drilled without subsequent application of approved cut-end treatment.

REGISTER FOR YOUR
15 YEAR
ANTI-ROT
GUARANTEE TODAY

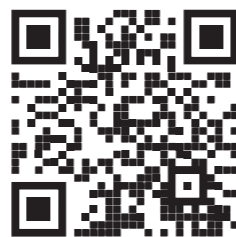

www.mgplogistics.co.uk

2

Anti-rot Guarantee

Mercia Garden Products offer a 10 year anti-rot guarantee on all dip treated (a preparatory treatment) and 15 years on all pressure treated products. This guarantee covers solid timber against rot, decay, blue stain and insect attacks.

To validate the guarantee, the building must be treated (as detailed within manufacturer's recommendations) within 14 days (weather permitting) of assembly and annually thereafter.

This guarantee does not cover movement, warping or splitting of timber products over time.

This guarantee will be voided if any of the following occur:

1. The building has been customised or modified/adapted in any way.
2. The person claiming is not the original purchaser of the building.
3. Any damage is caused by or as a result of misuse.
4. The building has not been maintained and cared for in accordance to our advisories and manufacturer's recommendations.
5. The building has not been treated annually or as per the manufacturer's recommendations, please ensure receipts are kept to validate this claim.
6. The building has not been erected, fitted or installed as per the supplier instructions.
7. The building has not been erected on a suitable sized firm flat, solid level concrete/slab base or placed on pressure treated bearers.
8. The building is or has been placed with 600mm of any obstructions (walls, trees, plants, fences etc.) which can allow moisture to penetrate the timber.
9. The roofing felt has been incorrectly fitted or damaged allowing water ingress, or has not been properly maintained.
10. Any windows and joints have not been sealed, inside and out, with silicone or other watertight sealant.
11. Any timber has been cut, pierced or drilled without subsequent application of approved cut-end treatment.