

03DTSHPN0806PA-V1
8X6 SHIPLAP PENT PATIO AREA.

BEFORE YOU START PLEASE READ INSTRUCTIONS CAREFULLY

- Check the pack and make sure you have all the items listed in the parts list provided.
- When you are ready to start, make sure you have the right tools at hand (not supplied - see the equipment list on next page).
- Ensure there is plenty of space and a clean dry area for assembly.
- Ensure you have enough time to build the product to ensure the building is water tight.

LOCATION FOR YOUR GARDEN BUILDING

A minimum of 600mm should be left around the perimeter of your garden building to allow access for maintenance, annual treatment and to allow air flow around the building.

Where possible you should avoid placing your garden building underneath large trees to prevent the tree causing damage to the building.

TIMBER

As with all natural materials, timber can be affected during various weather conditions. For the duration of heavy or extended periods of rain, swelling of the wood panels may occur. Warping of the wood may also occur during excessive dry spells due to an interior moisture loss. Unfortunately, these processes cannot be avoided but can be helped. It is suggested that the outdoor building is sprayed with water during extended periods of warm sunshine and sheltered as much as possible during rain or snow.

Once your garden building has been installed it will need to be treated within 14 days (weather permitting) and annually to prevent the timber from deteriorating and to waterproof it. This is required to maintain the anti-rot guarantee.

- Dip Treated buildings - Require a preservative treatment to protect against rot and decay and a waterproof treatment to prevent water ingress
- Pressure Treated buildings - Require a waterproof treatment to prevent water ingress
- Log Cabins/Insulated Garden Rooms - Are supplied untreated and require a preservative and waterproofing treatment.

BUILDING A BASE

When thinking about where the building and where the base is going to be constructed: Ensure that there will be access to all sides for maintenance work and annual treatment.

Ensure the base is level and is built on firm ground, to prevent distortion. Refer to diagrams for the base dimensions, The base should be slightly smaller than the external measurement of the building, i.e. The cladding should overlap the base, creating a run off for water. It is also recommended that the floor be at least 25mm above the surrounding ground level to avoid flooding.

TYPES OF BASE

- Concrete 75mm laid on top of 75mm hard-core.
- Slabs laid on 50mm of sharp sand.
- Wooden base.

Whilst all products manufactured are made to the highest standards of safety and in the case of children's products independently tested to EN71 level, we cannot accept responsibility for your safety whilst erecting or using this product.



x2 All buildings should be erected by two adults



2mm Drill bit

For ease of assembly, you **MUST** pilot drill all screw holes and ensure all screw heads are countersunk.



For ease of assembly, you will need a tape measure to check dimensions of components.



Winter = High Moisture = Expansion
 Summer = Low Moisture = Contraction



CAUTION
 Every effort has been made during the manufacturing process to eliminate the prospect of splinters on rough surfaces of the timber. You are strongly advised to wear gloves when working with or handling rough sawn timber.

Screws & Nails



Measure overall length

Bolts



Measure under the head

To identify the fixings required for each step use a measuring tape.

****Protim Aquatan T5 (621)****

Your building has been dip treated with Aquatan.

Aquatan is a water-based concentrate which is diluted with water, the building as been treated by the correct application of Aquatan solution and then allowed to dry.

Aquatan is a decorative finish to colour the wood, which is applied industrially to timber fence panels and garden buildings.

Aquatan undiluted contains: boric acid, sodium hydroxide 32% solution, aqueous mixture of sodium dioctyl sulphosuccinat and alcohols: 2, 4, 6-trichlorophenol.



REGISTER FOR YOUR

ANTI-ROT

GUARANTEE TODAY

PLEASE SCAN HERE:



In all instances for assistance with your product, please contact customer care on :
 01636 821215 or customerservice@merciagp.co.uk

Mercia Garden Products Limited,
 Sutton On Trent,
 Newark,
 Nottinghamshire,
 NG23 6QN



TO DO LIST

- Find a suitable location to build *(see front cover for further information).*
- Build a base *(see front cover for further information).*
- Check the base is flat, level, clear of debris and has 60cm clearance on all sides.
- Check you have the required equipment.
- Check you have all the product items listed *(if you have missing or damaged parts please contact the customer services department, see front cover for contact details).*
- Install the product as per the step by step instructions within this pack.
- Prepare the product ready for treatment.
- Apply a preserving and a waterproofing treatment within 14 days *(weather permitting)* of installation *(pressure treated products do not require a preserver).*
- Register for your anti rot guarantee *(scan the QR below).*
- Tidy the build area and dispose of any remaining parts responsibly.
- Maintain your building *(see the manufacturers recommendations at the back of this pack).*

EQUIPMENT LIST

- Hammer
- Flat Head Screwdriver
- Drill
- Drill Bit Set
- Phillips and Slotted Bit Sets
- Tape Measure
- Hand Saw
- Spirit Level
- Ladders/Steps
- Stanley Knife/Cutting Tool
- Sand Paper
- Gloves
- Silicone (For Windows Only)
- Wood Filler (Optional)
- Timber Preservative Treatment *(not pressure treated products)*
- Timber Water Proofing Treatment
- Treatment Mixing Stick
- Paint Brush/Sprayer/Roller

NEED EXTRA SUPPORT

If you are unsure that your base preparation will be suitable, please contact us on 01636 821215 to discuss this further.

Alternatively, you can visit our website or MGP Logistics Online Portal for some further shededucation.

Website:

<https://www.merciagardenproducts.co.uk/sheducation>

MGP Logistics Online Portal:

<https://www.mgplogistics.co.uk/>

Here you will find plenty of useful information that'll help with most pre-installation and maintenance queries.



ANY QUESTIONS?
CONTACT US ON
01636 821215

NOTES

16x6 Pent & Right Side Patio Area

Overall Dimensions:
Width = 4774mm
Depth = 2331mm
Height = 2170mm

Base Dimensions:
Width = 4673mm
Depth = 1787mm

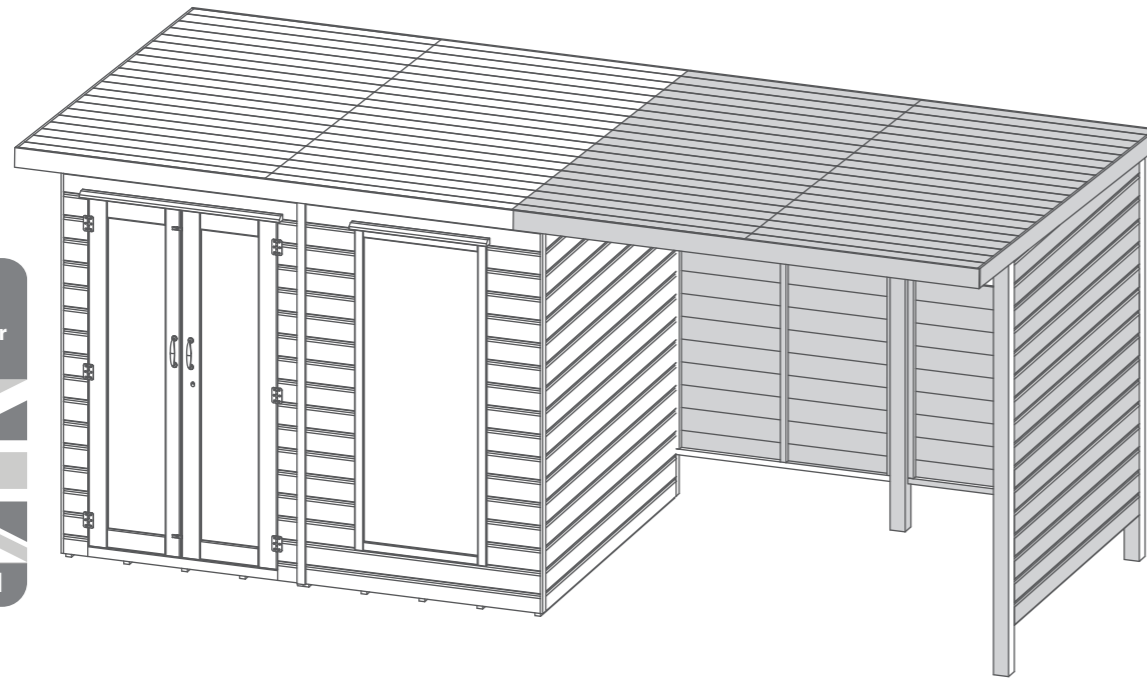

Pack Requirement:
03DTSHPN0806FGD1TW-V1
03DTSHPN0406PA-V1

16x6 Pent & Left Side Patio Area

Overall Dimensions:
Width = 4774mm
Depth = 2331mm
Height = 2170mm

Base Dimensions:
Width = 4673mm
Depth = 1787mm

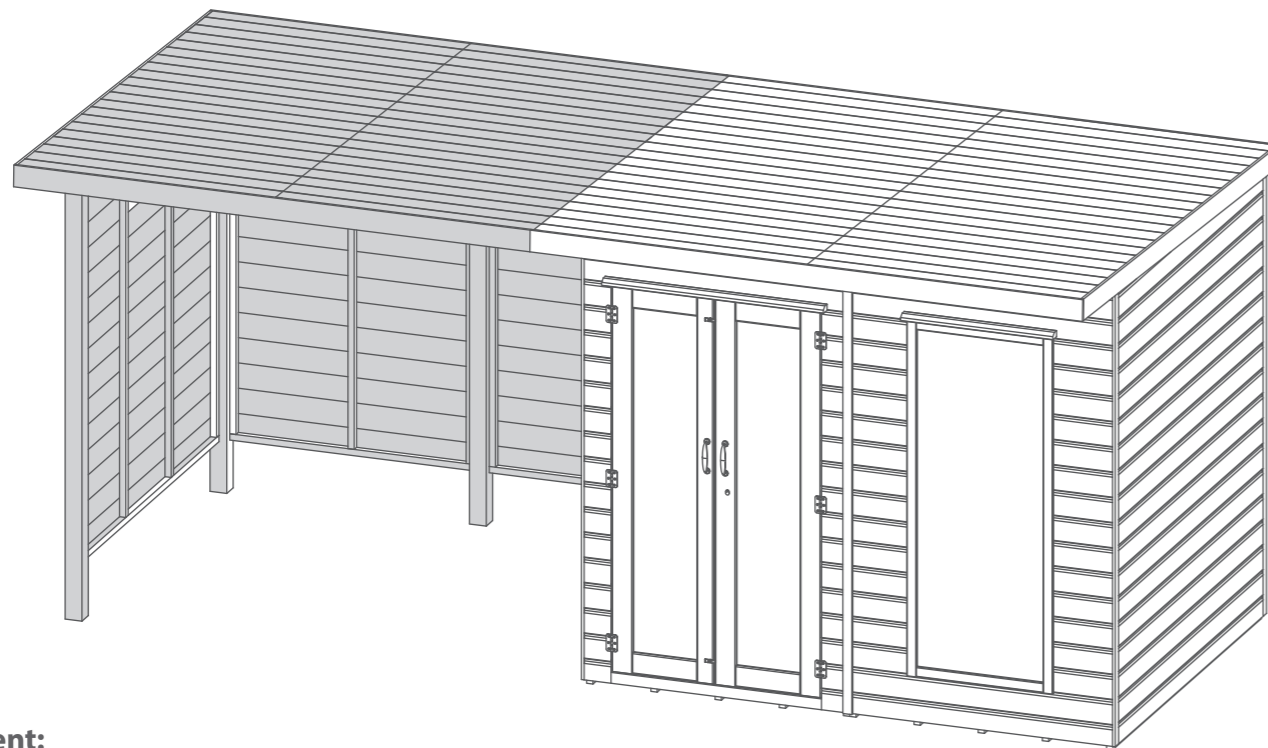

Pack Requirement:
03DTSHPN0806FGD1TW-V1
03DTSHPN0406PA-V1

18x6 Pent & Right Side Patio Area

Overall Dimensions:
Width = 5334mm
Depth = 2331mm
Height = 2170mm

Base Dimensions:
Width = 5234mm
Depth = 1787mm

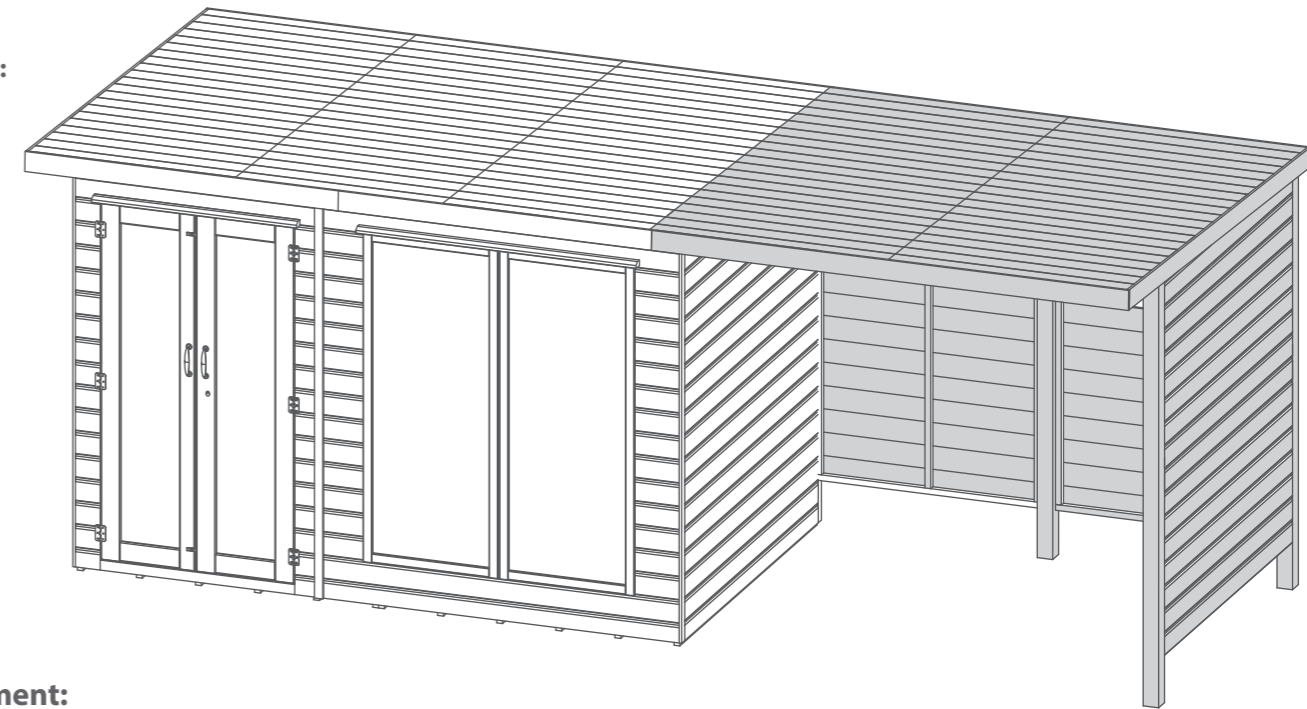

Pack Requirement:
03DTSHPN1006FGD2TW-V1
03DTSHPN0406PA-V1

18x6 Pent & Left Side Patio Area

Overall Dimensions:
Width = 5334mm
Depth = 2331mm
Height = 2170mm

Base Dimensions:
Width = 5234mm
Depth = 1787mm

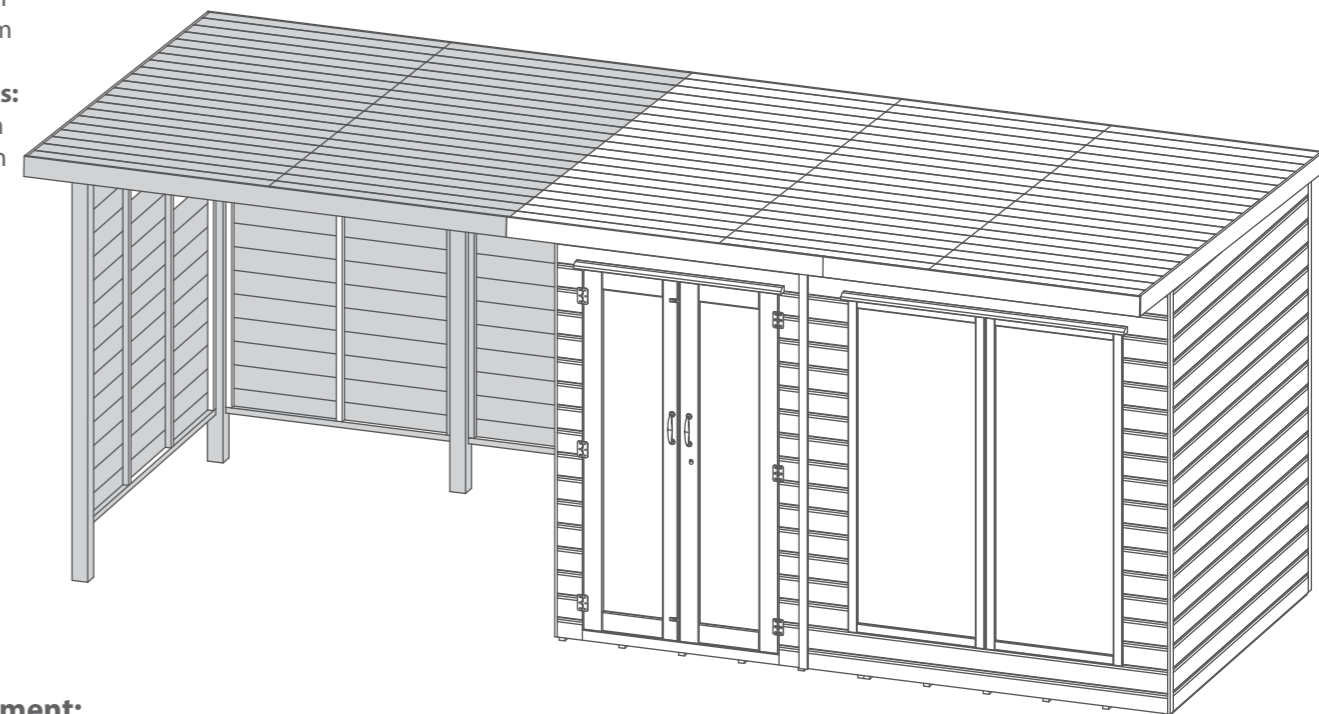

Pack Requirement:
03DTSHPN1006FGD2TW-V1
03DTSHPN0406PA-V1

Contents:

- 1**

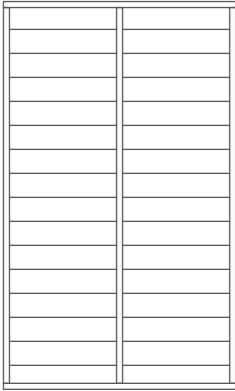

Back Panel QTY 2
AI-S11SHPPBF1078X1810-V1

2



Side Panel QTY 1
AI-S11SHPPBF1637X1810-V1

3

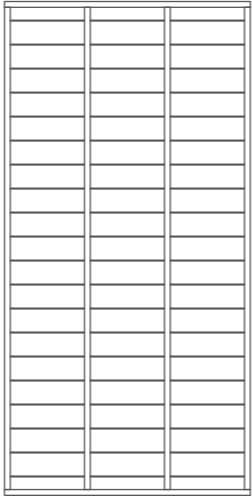

Roof QTY 2
AI-S11MBPR1147X2305-V1
- 4**

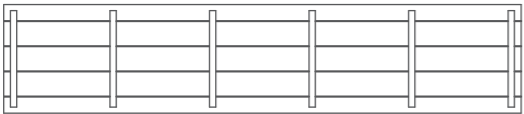

Under Roof QTY 1
AI-S11MBURF2294X484-V1

5



Front Panel QTY 1
AI-S11SHPPTBF2231X190-V1
- 6**



Front Post - 75x75x2138mm QTY 1
PI-04-0068
- 7**



Rear Post - 75x75x2078mm QTY 2
PI-04-0067
- 8**



Fascia Trim - 12x95x2294mm QTY 2
S1295-2294mm
- 9**

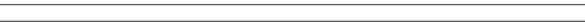

Roof Framing - 28x28x1147mm QTY 2
FS2828-1147mm
- 10**



Ridge Bar - 27x44x2219mm QTY 1
F2744-2219mm
- 11**



Felt
PI-01-0013
- 12**



Corner Brace QTY 2
PI-07-0012

Nail Bag

There may be extra screws present in the nail bag

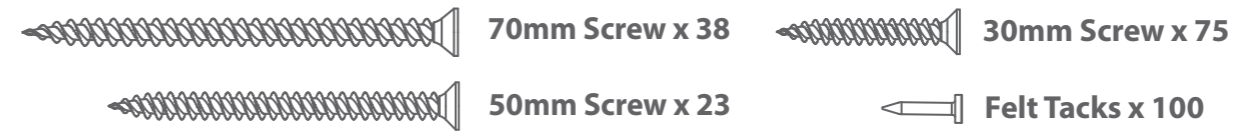

Pre-Assembly

Follow the instructions for the 8x6 Pent Summerhouse (03DTSHPN0806FGD1TW) or the the 10x6 Pent Summerhouse (03DTSHPN1006FGD2TW), however **DO NOT attach the Felt, Rear Cover Trims or the Fascia Trims.**

Not attaching these parts allows the extension to be fixed in place.

Your building should look as shown.

8x6 Pent Summerhouse
03DTSHPN0806FGD1TW-V1

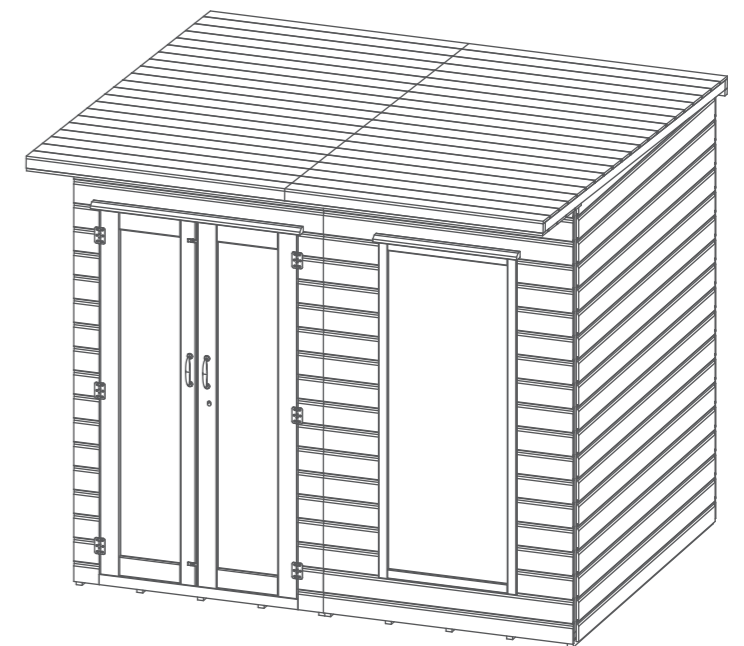

10x6 Pent Summerhouse
03DTSHPN0806FGD2TW-V1

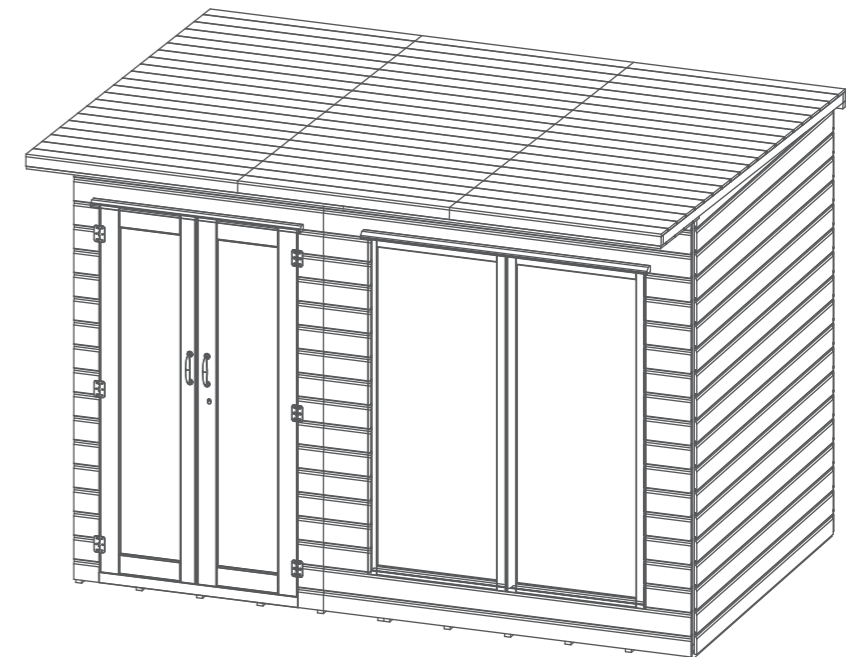

Step 1

Parts needed - No. 1 QTY 2
- No. 7 QTY 2

Lay the Back panels (No.1) on the floor and place the Back Posts (No.7) to the right side of the back panels. Make sure that you have a **225mm** space between the bottom of the Side Panel and the Posts.

Fix in position using 4x70mm screws either side as shown.

Hint: if you are having your patio on the left side of your building, attach the posts to the left side of the Back panels

8x70mm Screws

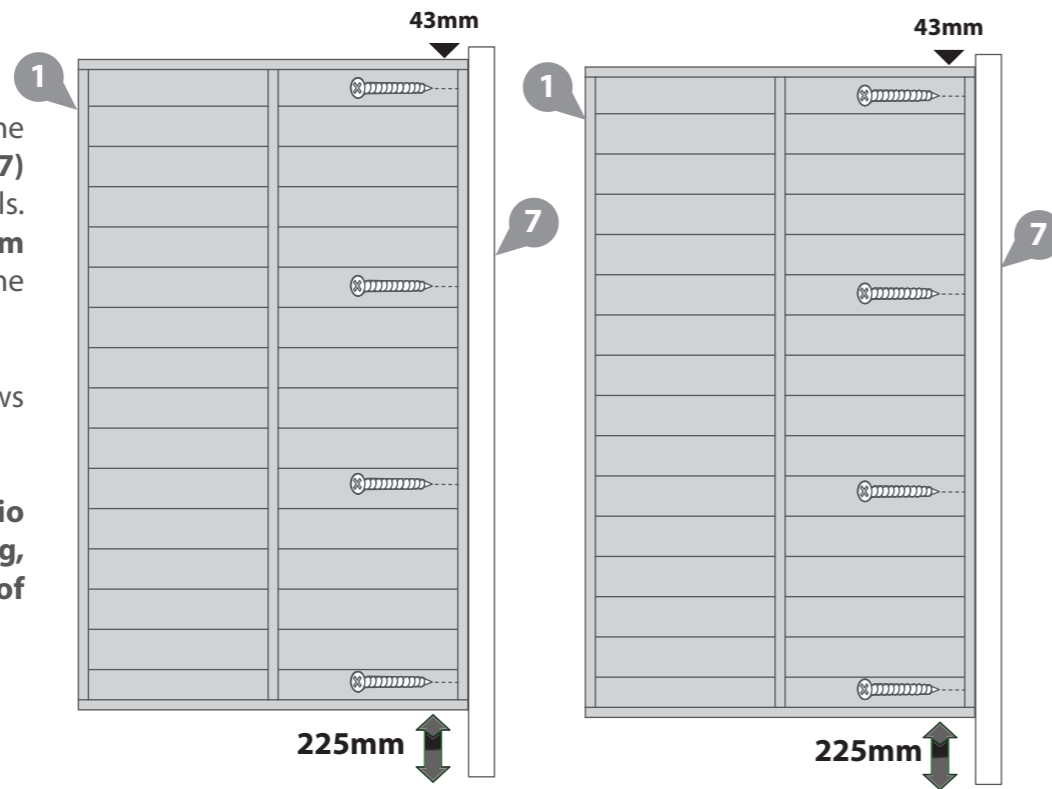
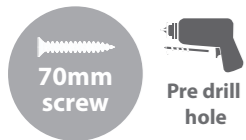

IMPORTANT: Pre-drill before fixing screws.

Step 3

Parts needed - No. 1 QTY 1

Locate the back panel (No.1) next to the standing back panel, ensure that it sits at the same height as the standing panel.

Secure using 4x70mm screws going through the back panel framing and into the back post as shown

4x70mm Screws

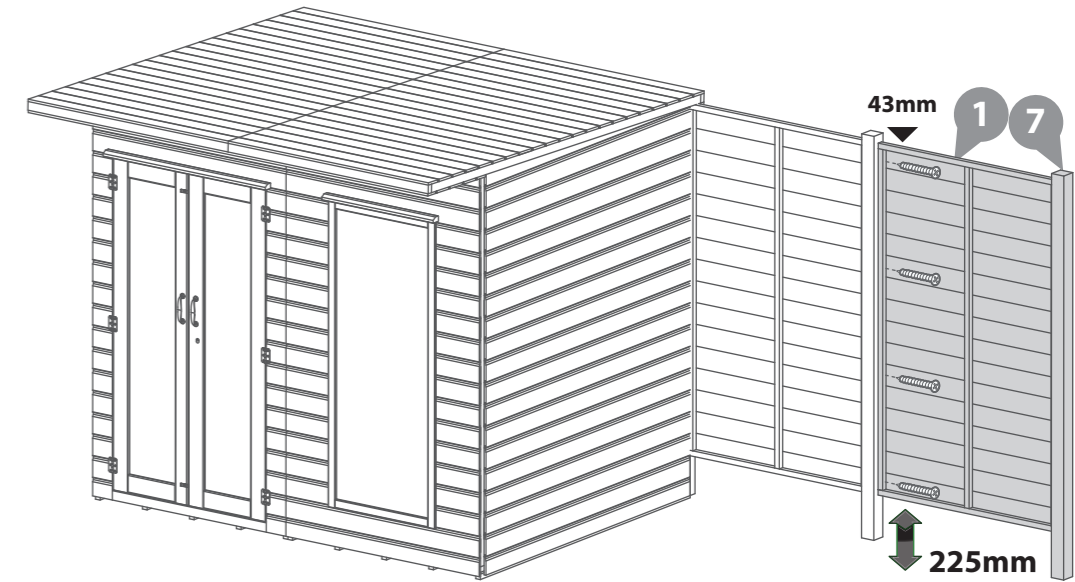

IMPORTANT: Pre-drill before fixing screws.

Step 2

Parts Needed- No. 1 QTY 1

Place the Back Panel (No.1) up against the Pent Summerhouse. Make sure that there is a Approx 225mm space between the bottom of the Panel and the ground. Also make sure that the cladding lines up with the panels on the existing Summerhouse. Fix into position using 4x50mm screws as shown.

****To position the shelter on the left, position the panel on the left and fix in the same way shown.****

4x50mm Screws

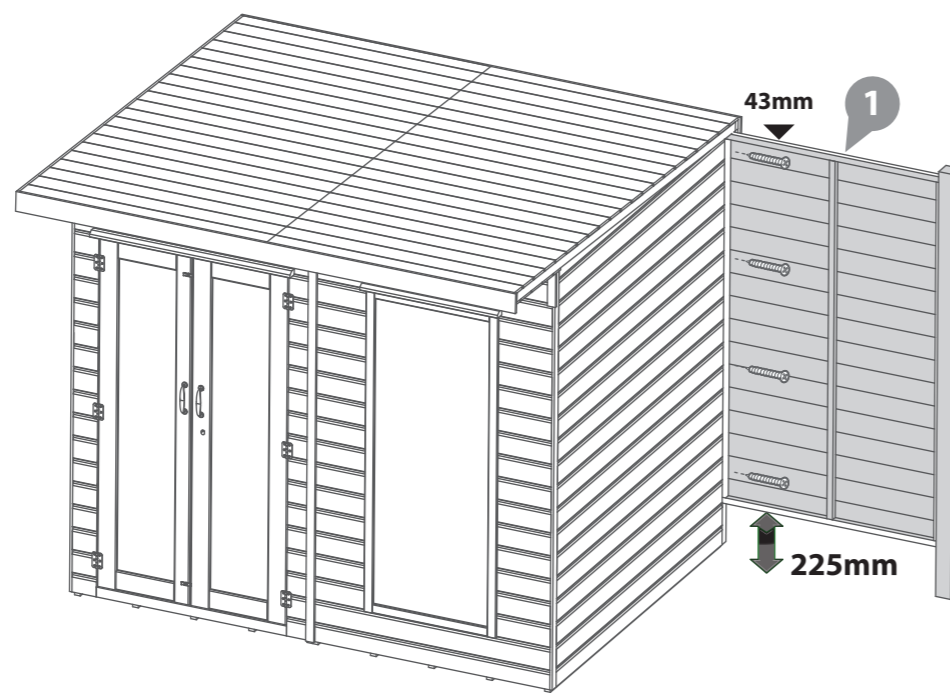
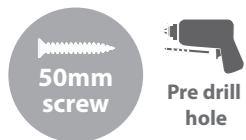

IMPORTANT: Pre-drill before fixing screws.

Step 4

Parts needed - No. 2 QTY 1
- No. 6 QTY 1

Lay the Side panel (No.2) on the floor and place the Front (No.6) Post. Make sure that you have a **225mm** space between the bottom of the Side Panel and the Posts.

Fix in position using 4x70mm screws either side as shown.

8x6 & 10x6 Pent Summerhouse not shown

4x70mm Screws



IMPORTANT: Pre-drill before fixing screws.

****The 8x6 Pent Summerhouse has been used for illustrative purposes.**

The process of constructing the summerhouse is the same regardless of the size of the Summerhouse.**

Step 5

Parts needed - No. 2 QTY 1

Stand the Side Panel (No.2) and the Front Post (No.6) to the Back post, ensuring the bottom of the side panel sits 225mm above the floor. Secure using 4x70mm screws

4x70mm Screws

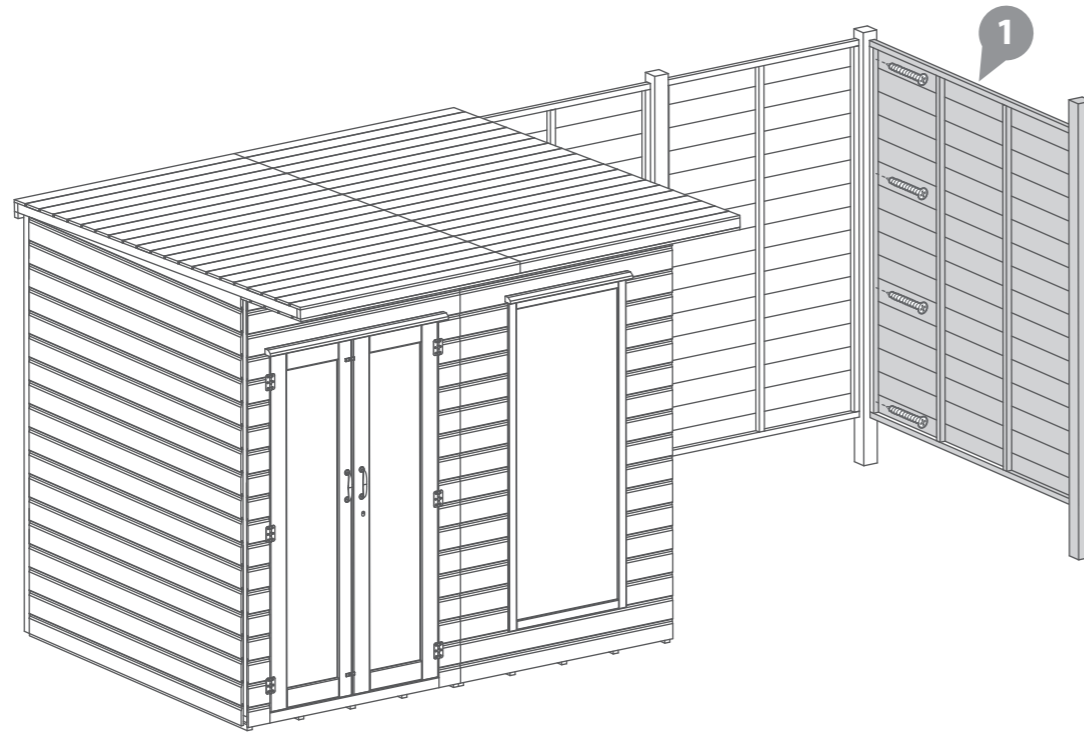
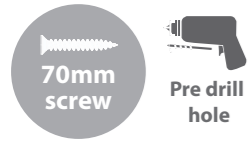

IMPORTANT: Pre-drill before fixing screws.

Step 7

Parts Needed- No.10 QTY 1
- No.12 QTY 2

Fix the corner braces (No.12) to each end of the ridge bar (No.10) using 2x30mm screws per corner brace

Place the Ridge Bar (No.10) between the summer house and the front post, ensure the ridge bar is flush to the roof framing. Secure using 2x30mm screws per corner brace

Fix the ridge bar (No.10) to the front panel (No.5) using 5x50mm, ensuring to go through the ridge bar and into the front panel framing behind

8x30mm Screws
5x50mm Screws

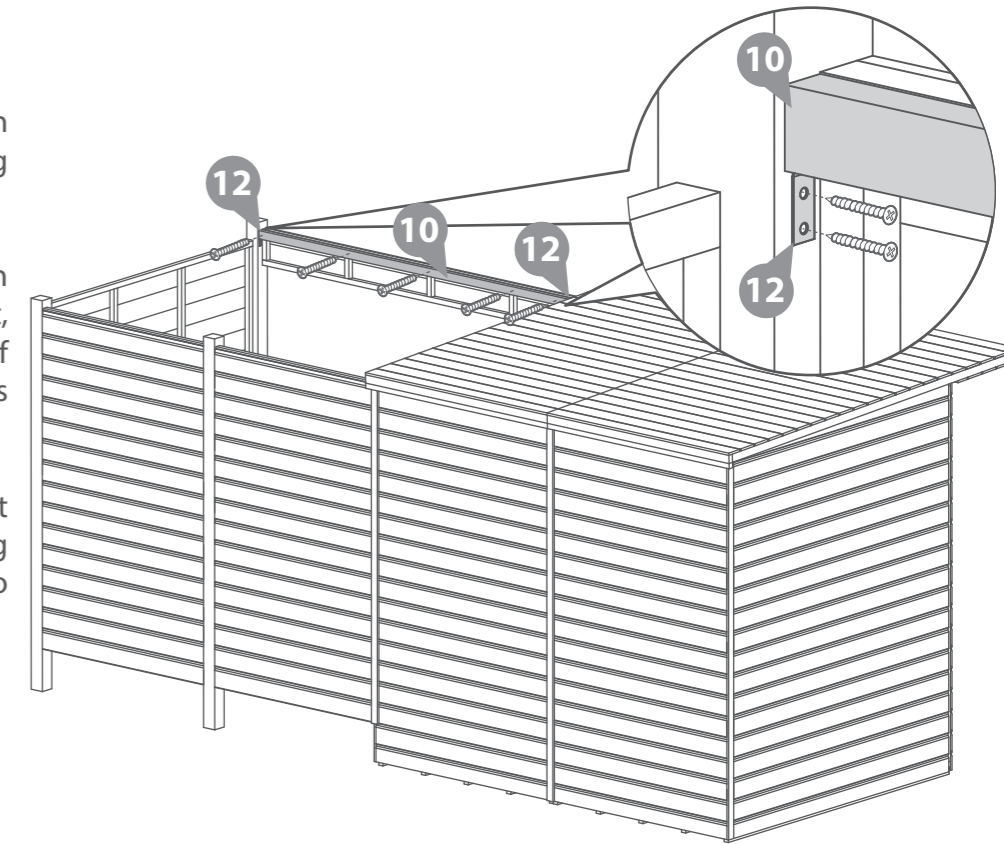
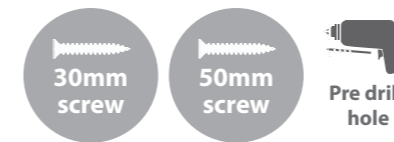

IMPORTANT: Pre-drill before fixing screws.

Step 6

Parts Needed- No.5 QTY 1

Fix the Front Panel (No.5) between the side of the 8x6 Pent Summerhouse or 10x6 Pent Summerhouse Side Panel (as shown using 2x50mm screws) and the Front Post (No.6) (as shown using 2x70mm screws).

Ensure the panel is square and level with the building before fixing into place

Make sure that the cladding lines up with the panels on the existing Summerhouse.

2x50mm Screws
2x70mm Screws

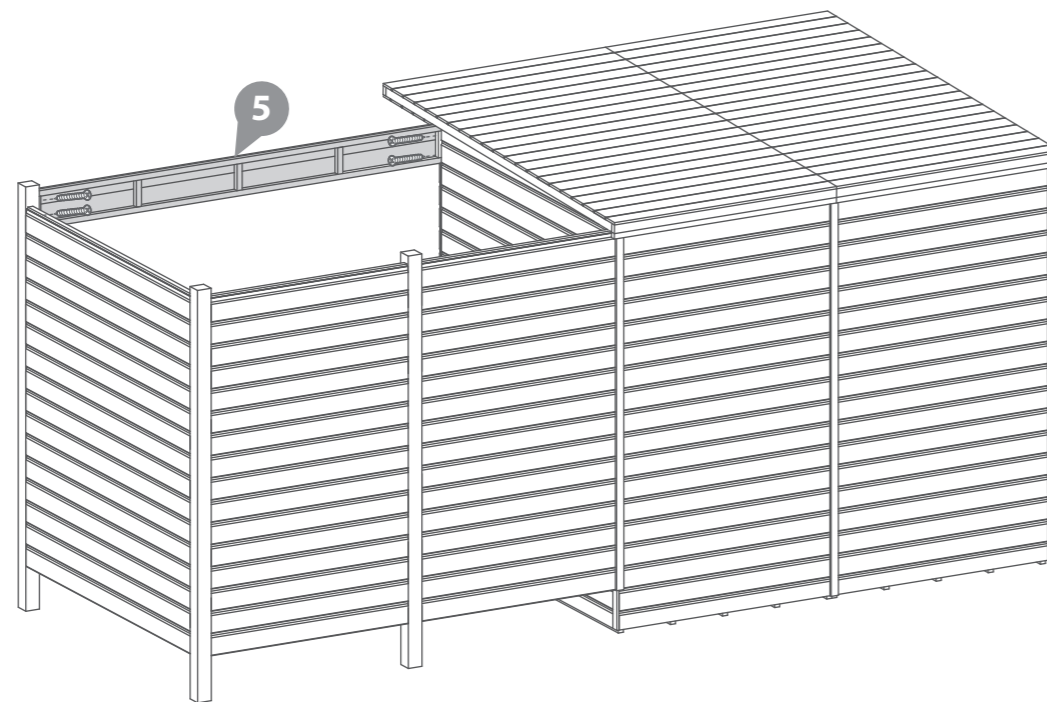
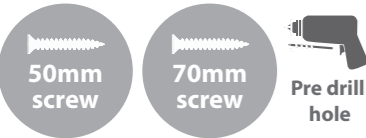

IMPORTANT: Pre-drill before fixing screws.

Step 8

Parts needed - No.3 QTY 2
- No.9 QTY 2

Fix the Roof Framing (No.9) to the roof (No.3) using 4x50mm screws, screwing through the Roof Framing and into the roof below.

Ensure the Roof Framing is flush to the edge of the roof before securing.

8x50mm Screws

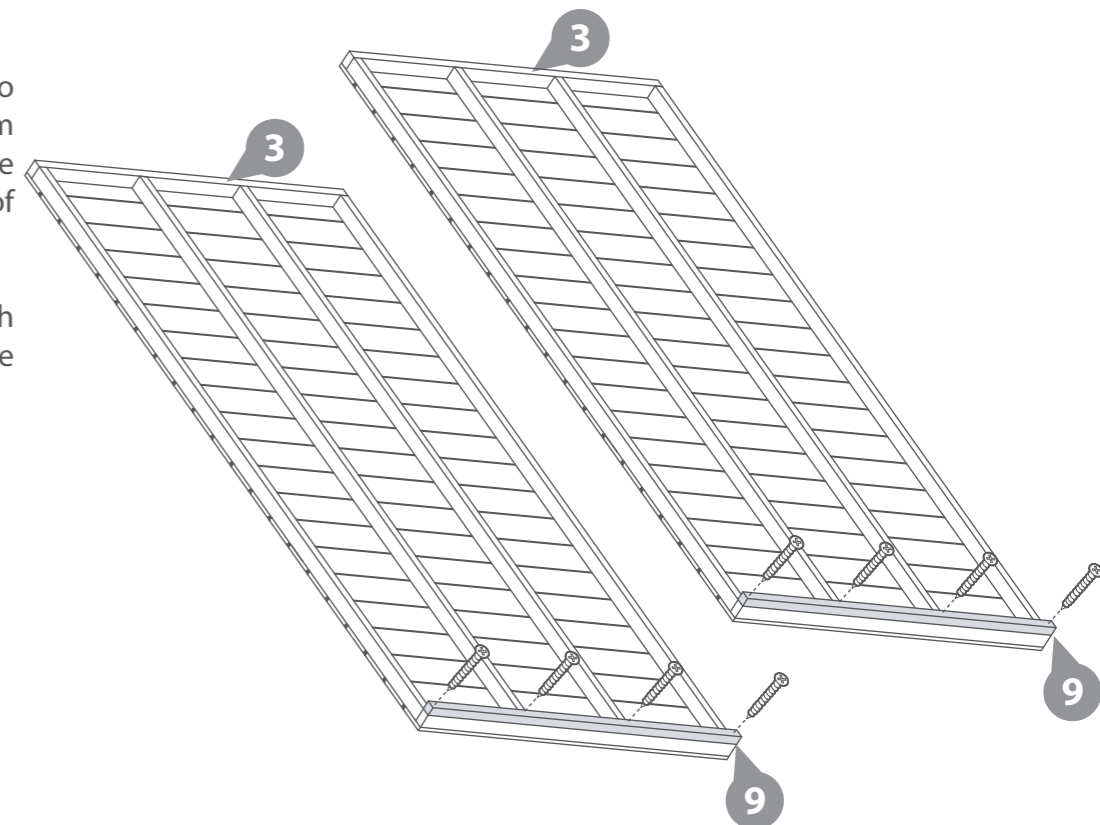
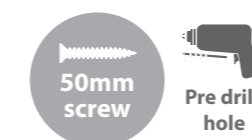

IMPORTANT: Pre-drill before fixing screws.

Step 9

Parts Needed- No.3 QTY 2

Place the Roof Panels (No.3) on top of the building, ensure the Roof framing (No.9) slots over the back panel.

Fix the roof panel onto the extension using 8x70mm screws as shown. Ensure there is no more than 300mm between each screw.

Secure the roofs together internally using 4x50mm screws per join through the roof bearers, as shown in the diagram.

8x50mm Screws
16x70mm Screws



IMPORTANT: Pre-drill before fixing screws.

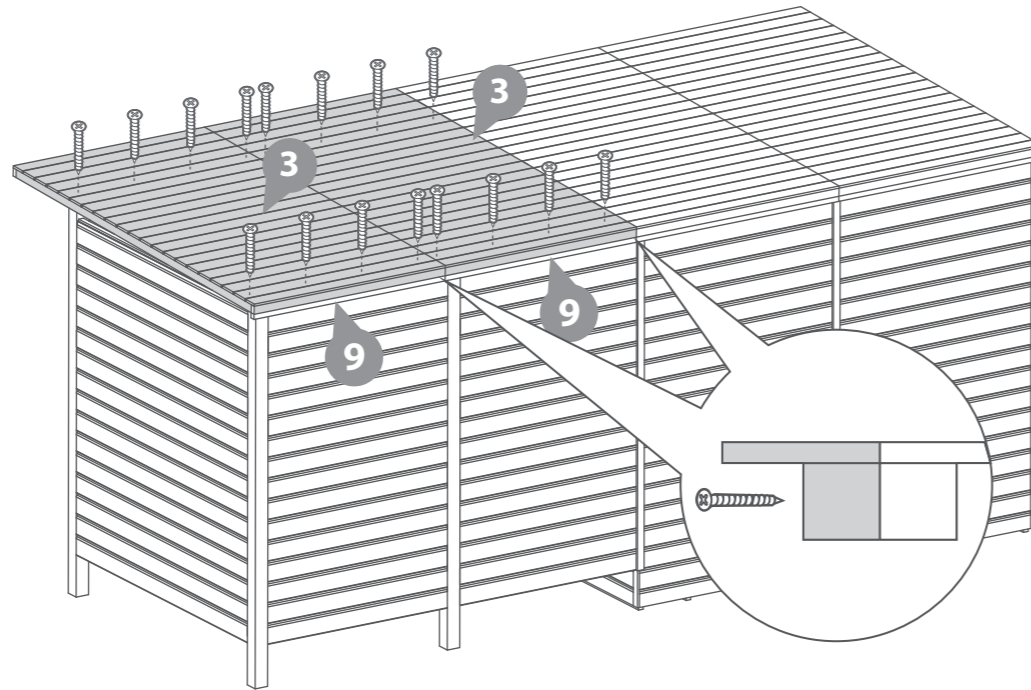

Step 11

Parts needed - No. 11 QTY 3

Cut the felt to 3 strips of (No.11):

8x6 Summerhouse :
5000mm (L) X 1000mm (W).

10x6 Summerhouse:
5550mm (L) X 1000mm (W).

Lay the Felt onto the roof. Starting at the back and working towards the front.

***Ensure there is approximately 50mm of overhang around the building.**

Fix into place using Felt Tacks at 100mm intervals.

100 x Felt tacks

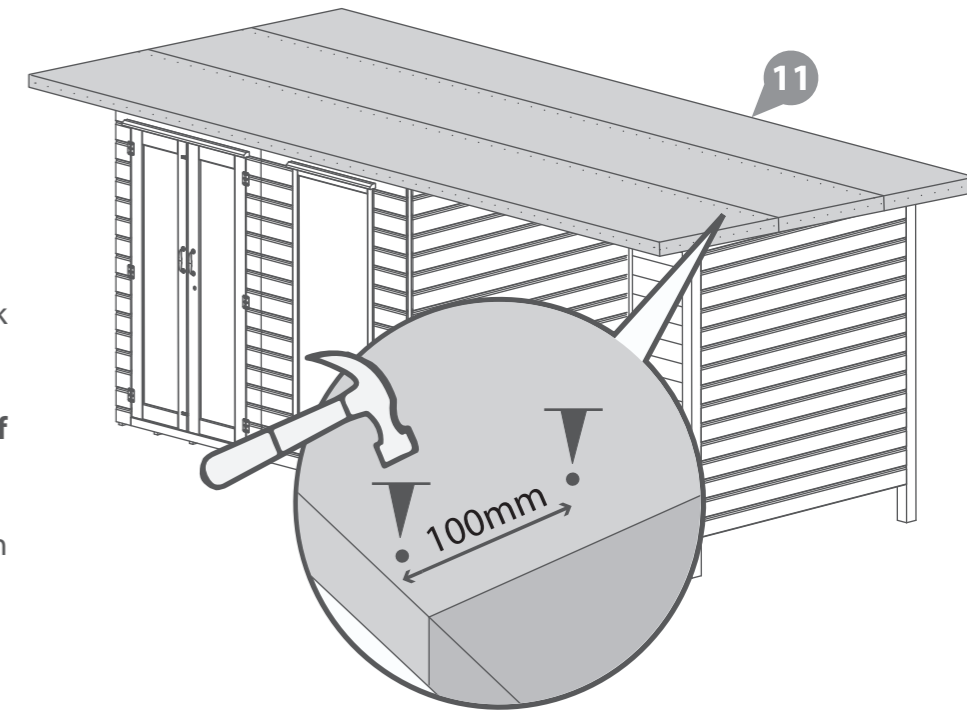

Step 10

Parts needed - No.4 QTY 1

Place the Under Roof Panel (No.4) into position, making sure it is flush to the front of the building. Using a pencil mark on the under roof panel where the roof panel framing is to use as a guide for fixing into place.

Fix in place making sure to screw through in to the Roof framing. Pre-drill holes first.

21x30mm Screws



IMPORTANT: Pre-drill before fixing screws.

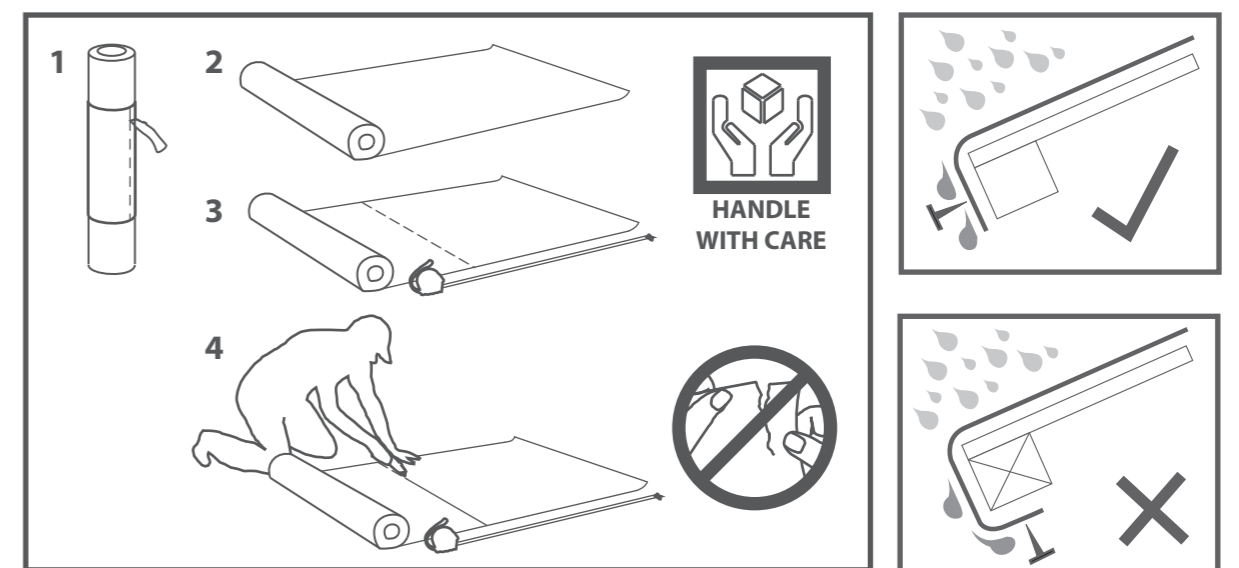
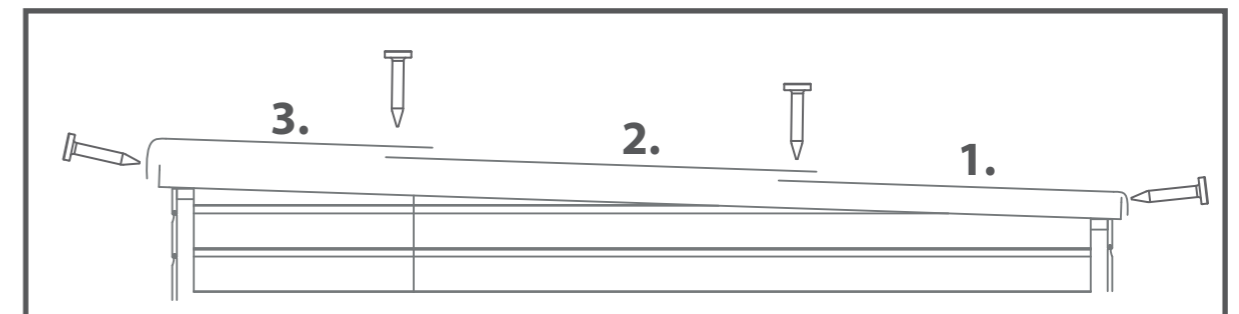
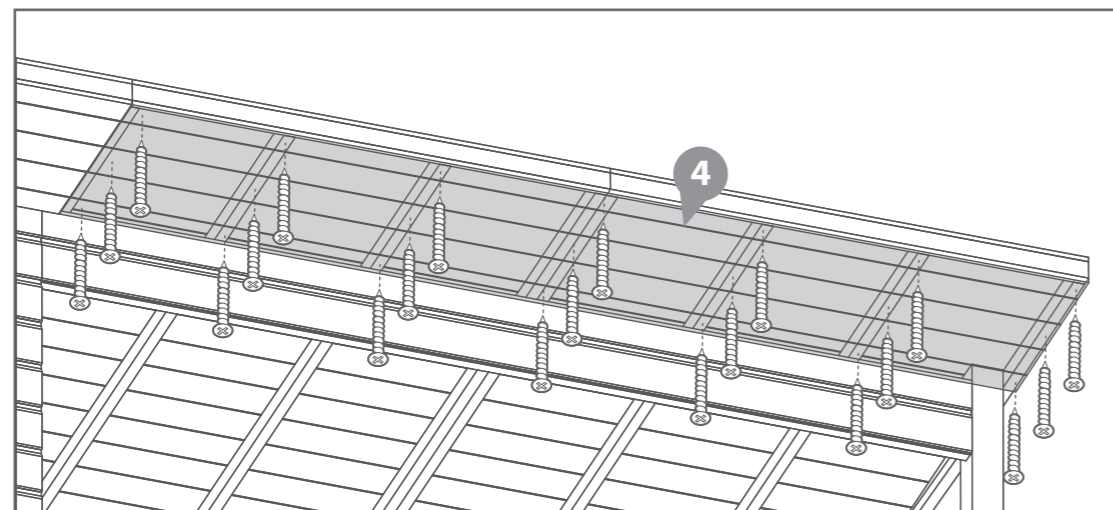

Step 12

Parts Needed - No. 8 QTY 2

Fix the Fascia Trims (No.8) plus the remaining Fascia Trims from the 8x6 Pent Summerhouse or the 10x6 Summerhouse into place using 4x30mm screws per Trim.

IMPORTANT: Pre-drill before fixing screws.

24x30mm Screws

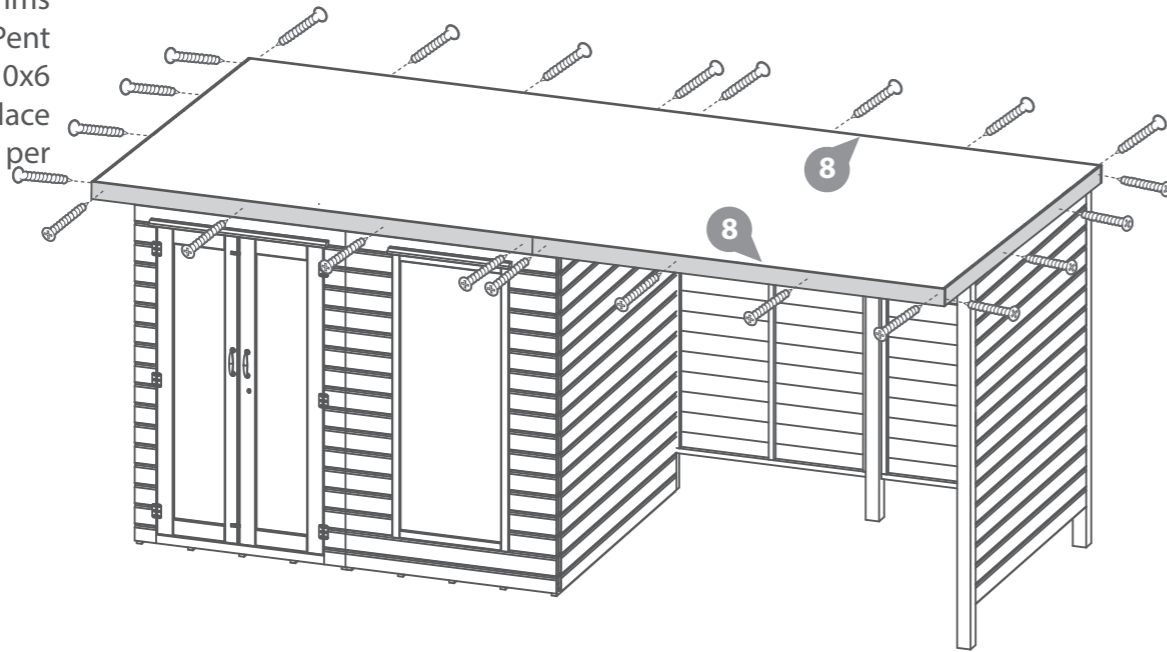
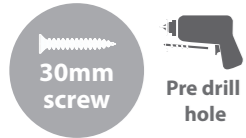

It is **ESSENTIAL** that you apply wood treatment immediately after the building has been assembled.

Step 13

Fix the remaining Cover Trims from the 8x6 Pent Summerhouse or the 10x6 Summerhouse into place over the panel joins using 3x30mm screws per Trim.

IMPORTANT: Pre-drill before fixing screws.

Cut down the last two Cover Trims and place over the panel joins as shown in the illustration using 3x30mm screws per large Trim and 2x30mm screws per short Trim.

22x30mm Screws

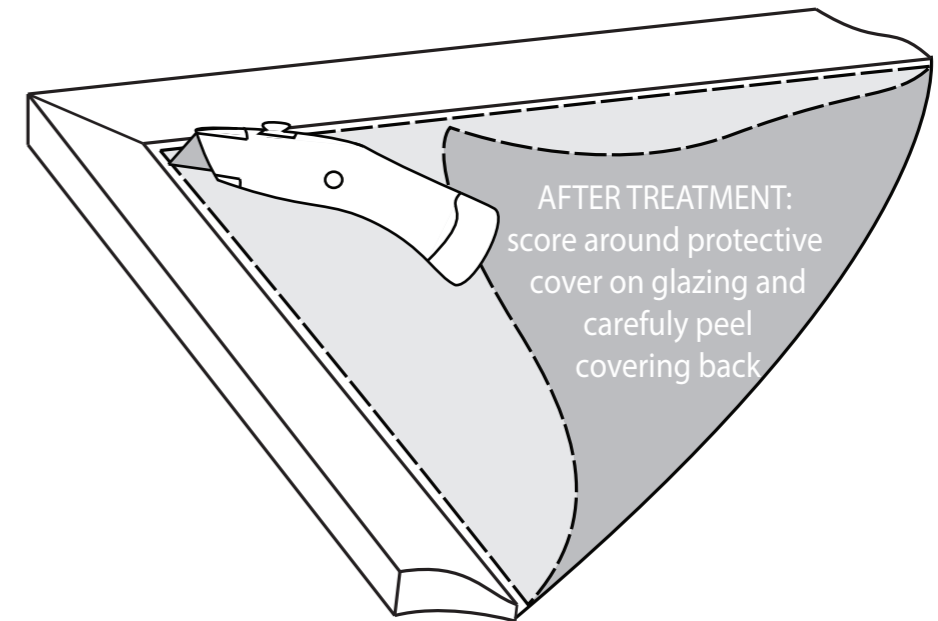
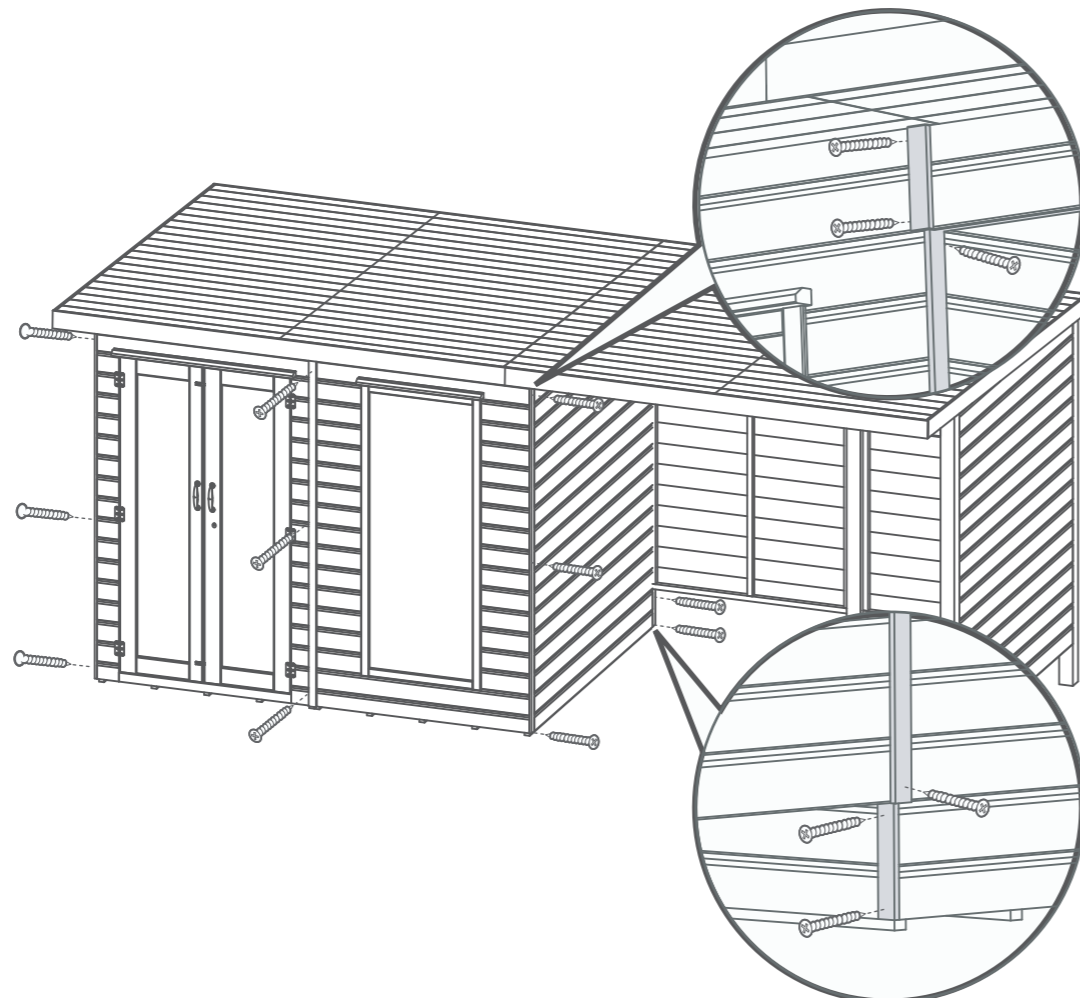
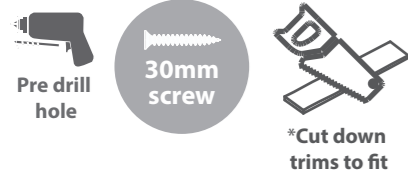

AFTER TREATMENT: score around protective cover on glazing and carefully peel covering back

TREATING YOUR GARDEN BUILDING

Preservation of wood that's outdoors is vital. A little early care will help protect your garden building, improve its appearance and ensure maximum longevity. Insects, moisture, salt, and changing weather can have dramatic effects on the stability and appearance of your garden building. Once your building is installed, you've checked it over and you're happy with it, you can take a few basic precautions to prepare it for the elements. Treating your garden building helps prevent decay and, by repelling water, discourages the growth of moulds and fungi that could jeopardise the structural integrity of the wood.

Dip Treated buildings - Require a preservative treatment to protect against rot and decay and a waterproof treatment to prevent water ingress
Pressure Treated buildings - Require a waterproof treatment to prevent water ingress
Log Cabins/Insulated Garden Rooms - Are supplied untreated and require a preservative and waterproofing treatment.



ANY QUESTIONS?
CONTACT US ON
01636 821215

To apply a preservative and water proofing treatment (pressure treated products do not require a preserver), follow the manufacturer's instructions but in principle, stick to the following steps:

- ✓ Wear latex or rubber gloves, eye protection and (if spraying) a mask.
- ✓ Prepare the wood, by sanding down any ridges or inconsistencies in the wood, smoothing out knots and end-cuts.
- ✓ Choose a dry day to treat your garden building. If you're spraying rather than brushing paint on, avoid a windy day.
- ✓ Be sure you can safely reach all the sections you need to paint - and if you need a ladder, make sure it's safely positioned before climbing. Lay dust sheets around to avoid paint splatters on your base or surrounding plants.
- ✓ Tape around windowpanes to avoid smears when you're painting the frames.
- ✓ Keep pets and small children out of the way. The last thing you want is to have fur on your garden building paint, or little painted footprints all over your garden and home.
- ✓ Fill any gaps in the building's body with caulk or wood filler to prevent water and draughts getting in. Silicone based caulk is flexible and will move with the timber when temperature and humidity change. Allow to dry completely before treating. A handy tip for finding gaps is to go into your garden building and look for light leaking through joins and frames. If light gets in, then so will water.
- ✓ Liberally apply at least two coats of the treatment products with a brush or spray, taking care to allow the first coat to completely dry before applying the second.
- ✓ Make sure the solution permeates the whole of the surface area, especially around natural cracks, end cuts and nail/screw holes.



APPLY WOOD TREATMENT
IMMEDIATELY
AFTER ASSEMBLY

PLEASE SCAN HERE TO
SEE TREATMENT VIDEO:



1 Perimeter

Check around the perimeter of your product to ensure there are not trees or plants that are in contact with or overhanging the building. This can affect airflow and overhanging trees, or branches can damage the roof, it is advised to keep plants at a distance.

2 Repair

Inspect the interior and exterior of the product to look for splits, cracks, and holes. Although this is a natural occurrence it can be prevented. A wood filler can be used to close the splits, cracks, and holes.

3 Roof

Check your roof regularly for tears, splits, damaged wood and fallen debris. If you notice any of this immediate repair is critical.

4 Doors & Windows

Expansion and contraction can cause doors and windows to stick or become difficult to open. Small adjustments to the hinge position can be made to the doors and windows to allow free movement.

5 Oil

Hinges can seize up over time, apply lubricant to the hinges and locks annually.

6 Screws & Bolts

It is advised to check all screws and bolts and tighten any loose you might find. For log cabins specifically the storm braces will require loosening. During humidity and temperature changes (seasons) to allow expansion and contraction to prevent gaping, twisting, popping, and warping.

7 Wash

At least once a year, give the outside of your building a good wash, to remove cobwebs, leaves, or any other dirt that may accumulate on the exterior.

8 Airing

Airing your product regularly prevents the build up of condensation which can cause the timber to warp, bow, boards to pop, distortion, rot and mould. Condensation can build up over time or daily, it is caused by a rise and fall in temperature.

Excessive moisture levels within your building can cause water to collect on the roofs, walls and floors internally. Leaving doors and windows open regularly can help combat the natural moisture build up.

9 Clean & Tidy

It is good practice to clean the inside and outside of your product regularly. Clear out the contents, sweep the floor, remove dirt and cobwebs. Check for areas of damp and investigate the cause to remove and prevent future occurrences. Check the ground around your product for build up of debris such as leaves, remove and ensure there is clear ventilation underneath the floor.

Additional Playhouse Maintenance:

It is recommended that the following checks and maintenance are carried out at the beginning of each season as well as at regular intervals during the usage season.

- Check all nuts /bolts/ screws for tightness and tighten when required.
- Check for movement / opening of wood giving rise to protrusion of nail heads and tips.
- Check hinges.
- Replace defective parts in accordance with the manufacturers instructions.
- Check any crossbeams, suspensions and anchors.
- If a swing is included; check the swing seat, chains and ropes.

IF THESE CHECKS ARE NOT CARRIED OUT THE ACTIVITY TOY COULD BECOME A HAZARD

All our garden buildings have been designed and manufactured with care and attention to be the perfect addition to your outdoor space. To ensure you do get the best out of your new garden building and to increase the longevity we advise that you follow the product instructions and our manufacturer's recommendations as detailed below. Thank you for choosing a Mercia Garden product!

1 Choosing the most suitable location for your garden building...

A minimum of 60cm should be left around the perimeter of your garden building to allow access for maintenance, annual treatment and to allow air flow around the building.

Where possible you should avoid placing your garden building underneath large trees to prevent the tree causing damage to the building.

2 Preparing the base for your garden building...

All our buildings must be built on a firm, level base to ensure the longevity of the building and prevent the wood from distorting. We recommend either concrete, concrete slabs or a wooden base, such as our 'Portabase'.

The base should be slightly smaller than the external measurement of the building, i.e. the cladding should overlap the base, creating a run off for water and preventing water from pooling underneath the building.

We also recommend that the floor of the garden building is a minimum of 25mm above the surrounding ground level to avoid flooding.

3 After installation...

Once your garden building has been installed, it will need to be treated within 14 days (weather permitting) and annually to prevent the timber from deteriorating and to waterproof it. This is required to maintain the anti-rot guarantee.

Dip Treated buildings - Require a preservative treatment to protect against rot and decay

and a waterproof treatment to prevent water ingress.

Pressure Treated buildings - Require a waterproof treatment to prevent water ingress.

Log Cabins/Insulated Garden Rooms - Are supplied untreated and require a preservative and waterproofing treatment.

We also recommend using a silicon sealant on the inside and outside of the windows as soon as possible after assembly and treatment to fully seal the windows.

Roofing felt/covering should be checked annually and replaced or fixed accordingly.

4 General maintenance and wood characteristics

As wood is a natural material it may be affected by the following:

Shrinkage and warping - The timber used in the construction of your garden building will have retained some of its natural moisture content. The moisture content of the timber will vary, depending upon prevailing environmental conditions, which will result in the components either naturally expanding or contracting. As the components dry out, shrinkage may occur. A good waterproofing treatment from the start is the best protection to minimise the effect of moisture loss/intake.

In extended periods of very warm weather getting some moisture to the building will help the overall balance. You can do this by spraying it down lightly with a garden hose. In contrast, after snow fall try to remove the snow as best as possible from the roof to prevent moisture intake and to remove the extra weight.

Top tip - using a garden brush will help you to reach the highest part of the building to remove snow and any debris left from bad weather.

Damp and mould - During the winter months, cold and damp conditions can result in an increased amount of moisture within your garden building, especially when used infrequently. Condensation can form on the timber and other items stored within your garden building. If left this moisture is likely to cause mould and mildew.

To prevent the build-up of moisture, we recommend leaving the door or windows of your building open from time to time, to allow the fresh air to circulate. We also advise against storing wet or damp items in your garden building as this will also increase the level of moisture in the building. If mould or mildew does start to form within your building we recommend using an anti-mould cleaner to remove it and to prevent it spreading, which if left untreated could permanently damage your garden building.

Splits, cracks and knots - You may notice small splits and cracks in some components or holes may appear where knots shrink and fall out. This will not affect the structure of your Garden building however, if you wish to fill them this can be easily done using any good quality wood filler.

Sap - is naturally occurring in wood and may appear in some boards of your garden building. If you wish to remove the sap, we advise waiting until it is dry and then using a sharp knife to carefully remove it. If the removal of the sap causes a hole in the timber, we recommend using a good quality wood filler to fill it.

For more handy hints and tips on how to care and maintain your garden building please refer to the MGP Customer Portal at www.mgplogistics.co.uk

Any further questions?

Contact our
Customer Service
Team on:
01636 821215

1 Manufacturer's Warranty

All Mercia Garden Products are supplied with a 1 year warranty on all parts against manufacturing defects.
This warranty does not cover movement, warping or splitting of timber products over time.

This warranty will be voided if any of the following occur:

1. The building has been customised or modified/adapted in any way.
2. The person claiming is not the original purchaser of the building.
3. Any damage has been caused by or as a result of misuse.
4. The building has not been maintained and cared for in accordance to our advisories and manufacturer's recommendations.
5. The building has not been treated annually or as per the manufacturer's recommendations, please ensure receipts are kept to validate this claim.
6. The building has not been erected, fitted or installed as per the supplier instructions.
7. The building has not been erected on a suitable sized firm flat, solid level concrete/slab base or placed on pressure treated bearers.
8. The building is or has been placed with 2 feet (600mm) of any obstructions (walls, trees, plants, fences etc.) which can allow moisture to penetrate the timber.
9. The roofing felt has been incorrectly fitted or damaged, allowing water ingress, or has not been properly maintained.
10. Any windows and joints have not been sealed, inside and out, with silicone or other watertight sealant.
11. Any timber has been cut, pierced or drilled without subsequent application of approved cut-end treatment.

2 Anti-rot Guarantee

Mercia Garden Products offer a 10 year anti-rot guarantee on all dip treated (a preparatory treatment) and 15 years on all pressure treated products. This guarantee covers solid timber against rot, decay, blue stain and insect attacks.

To validate the guarantee, the building must be treated (as detailed within manufacturer's recommendations) within 14 days (weather permitting) of assembly and annually thereafter.

This guarantee does not cover movement, warping or splitting of timber products over time.

This guarantee will be voided if any of the following occur:

1. The building has been customised or modified/adapted in any way.
2. The person claiming is not the original purchaser of the building.
3. Any damage is caused by or as a result of misuse.
4. The building has not been maintained and cared for in accordance to our advisories and manufacturer's recommendations.
5. The building has not been treated annually or as per the manufacturer's recommendations, please ensure receipts are kept to validate this claim.
6. The building has not been erected, fitted or installed as per the supplier instructions.
7. The building has not been erected on a suitable sized firm flat, solid level concrete/slab base or placed on pressure treated bearers.
8. The building is or has been placed with 600mm of any obstructions (walls, trees, plants, fences etc.) which can allow moisture to penetrate the timber.
9. The roofing felt has been incorrectly fitted or damaged allowing water ingress, or has not been properly maintained.
10. Any windows and joints have not been sealed, inside and out, with silicone or other watertight sealant.
11. Any timber has been cut, pierced or drilled without subsequent application of approved cut-end treatment.



REGISTER FOR YOUR
ANTI-ROT
GUARANTEE TODAY

PLEASE SCAN HERE:

