

**04DTSTRDAX0806HGS-V1**

**DIP TREATED 8X6 STANDARD APEX GREENHOUSE**

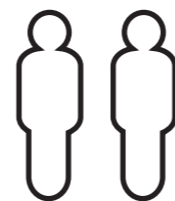

**x2**

All buildings should be erected by two adults



**2mm Drill bit**

For ease of assembly, you **MUST** pilot drill all screw holes and ensure all screw heads are countersunk.



For ease of assembly, you will need a tape measure to check dimensions of components and fixings.



Winter = High Moisture = Expansion  
Summer = Low Moisture = Contraction



**CAUTION**

Every effort has been made during the manufacturing process to eliminate the prospect of splinters on rough surfaces of the timber. You are strongly advised to wear gloves when working with or handling rough sawn timber.

**\*\*Protim Aquatan T5 (621)\*\***

Your building has been dip treated with Aquatan.

Aquatan is a water-based concentrate which is diluted with water, the building has been treated by the correct application of Aquatan solution and then allowed to dry.

Aquatan is a decorative finish to colour the wood, which is applied industrially to timber fence panels and garden buildings.

Aquatan undiluted contains: boric acid, sodium hydroxide 32% solution, aqueous mixture of sodium dioctyl sulphosuccinat and alcohols: 2, 4, 6-trichlorophenol.

**REGISTER FOR YOUR  
10 YEAR  
ANTI-ROT  
GUARANTEE TODAY**

In all instances for assistance with your product or to register your anti rot guarantee, please contact us via our customer portal



[www.mgplistics.co.uk](http://www.mgplistics.co.uk)

Mercia Garden Products Limited, Sutton On Trent, Newark, Nottinghamshire, NG23 6QN

**Screws & Nails**

Measure overall length

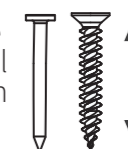

**Bolts**

Measure under the head

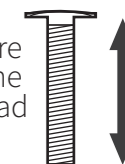

**BEFORE YOU START PLEASE READ THE INSTRUCTIONS CAREFULLY**

- Check the pack and make sure you have all the items listed in the parts list provided.
- When you are ready to start, make sure you have the right tools at hand (not supplied - see the equipment list on next page).
- Ensure there is plenty of space and a clean dry area for assembly.
- Ensure you have enough time to build the product to ensure the building is water tight.

**LOCATION FOR YOUR GARDEN BUILDING**

A minimum of 600mm should be left around the perimeter of your garden building to allow access for maintenance, annual treatment and to allow air flow around the building.

Where possible you should avoid placing your garden building underneath large trees to prevent the tree causing damage to the building.

**BUILDING A BASE**

When thinking about where the building and where the base is going to be constructed: Ensure that there will be access to all sides for maintenance work and annual treatment.

Ensure the base is level and is built on firm ground, to prevent movement. Refer to the contents page for the base dimensions. The base should be slightly smaller than the external measurement of the building, i.e. The cladding should overlap the base, creating a run off for water. It is also recommended that the floor be at least 25mm above the surrounding ground level to avoid flooding.

**TYPES OF BASE**

- Concrete 75mm laid on top of 75mm hard-core.
- Slabs laid on 50mm of sharp sand.
- Wooden base - Levelled / on posts / ground screws.

**TREATMENT**

Once your garden building has been installed it will need to be treated within 14 days (weather permitting) and annually to prevent the timber from deteriorating and to waterproof it. This is required to maintain the anti-rot guarantee.

Dip Treated buildings - Require a preservative treatment to protect against rot and decay and a waterproof treatment to prevent water ingress

Pressure Treated buildings - Require a waterproof treatment to prevent water ingress

Log Cabins/Insulated Garden Rooms - Are supplied untreated and require a preservative and waterproofing treatment.

**TIMBER**

As with all natural materials, timber can be affected during various weather conditions. For the duration of heavy or extended periods of rain, swelling of the wood panels may occur. Warping of the wood may also occur during excessive dry spells due to an interior moisture loss. Unfortunately, these processes cannot be avoided but can be helped. It is suggested that the outdoor building is sprayed with water during extended periods of warm sunshine and sheltered as much as possible during rain or snow.

Whilst all products manufactured are made to the highest standards of safety and in the case of children's products independently tested to EN71 level, we cannot accept responsibility for your safety whilst erecting or using this product.



## TO DO LIST

- Find a suitable location to build (*see front cover for further information*).
- Build a base (*see front cover for further information*).
- Check the base is flat, level, clear of debris and has 60cm clearance on all sides.
- Check you have the required equipment / tools.
- Check you have all the product items listed (*if you have missing or damaged parts please scan the QR code below to visit our online customer portal*).
- Install the product as per the step by step instructions within this pack.
- Prepare the product ready for treatment (this may include sanding).
- Apply a preserving and a waterproofing treatment within 14 days (*weather permitting*) of installation (*pressure treated products do not require a preserver*).
- Register for your anti rot guarantee (*scan the QR below*).
- Tidy the build area and dispose of any remaining parts responsibly.
- Maintain your building (*see the manufacturers recommendations at the back of this pack*).

## EQUIPMENT LIST

- Hammer
- Flat Head Screwdriver
- Drill
- Drill Bit Set
- Phillips and Slotted Bit Sets
- Tape Measure
- Hand Saw
- Spirit Level
- Ladders/Steps
- Stanley Knife/Cutting Tool
- Sand Paper
- Gloves
- Silicone (For Windows Only)
- Sealant Application Gun
- Wood Filler (Optional)
- Timber Preservative Treatment (*not pressure treated products*)
- Timber Water Proofing Treatment
- Treatment Mixing Stick
- Paint Brush/Sprayer/Roller

## NEED EXTRA SUPPORT

If you are unsure that your base preparation will be suitable, please contact us via our customer portal to discuss this further.

Alternatively, you can visit our website or MGP Logistics Online Portal for some further shededucation.

**Website:**

<https://www.merciagardenproducts.co.uk/sheducation>

**MGP Logistics Online Portal:**

<https://www.mgplogistics.co.uk/>

Here you will find plenty of useful information that'll help with most pre-installation and maintenance queries.

**ANY QUESTIONS?**

Scan the QR code to contact us via our customer portal.

## NOTES

## ACCESSING VIDEO GUIDES...

Some steps within this set of instructions come with an added video guide for your convenience. These can be accessed via the QR code and used to aid you in constructing that step. See below for how to use.

You can also find all the videos on our youtube channel:  
<https://www.youtube.com/@merciagardenproducts8716/videos>

### 1. Find the QR code within the instruction step...

#### Step.....

Parts Needed- No. QTY 1  
No. QTY 1  
No. QTY 1

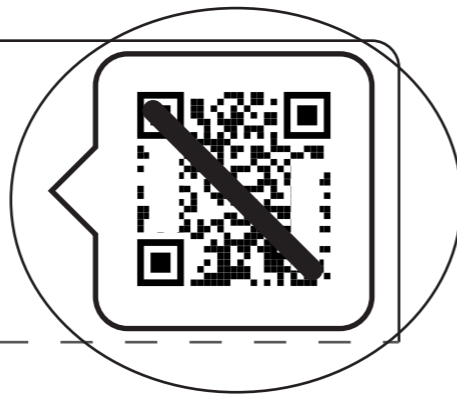

Within the instruction step, there will be an icon in the top right that has a QR code in. This is where the video can be accessed from.

*Please note: not every step has a video guide.*

### 2. Open camera app...

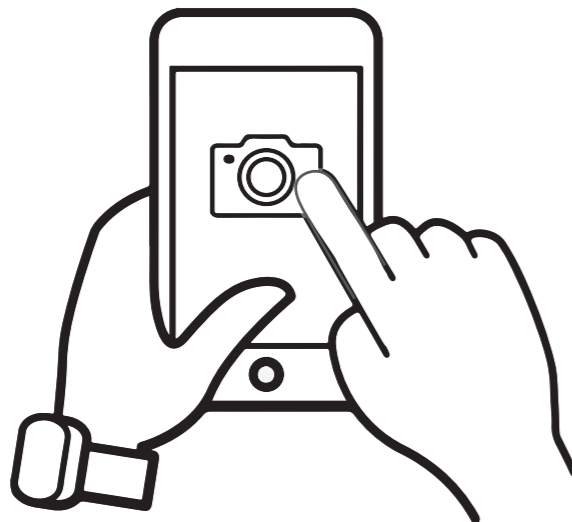

On your personal smart device (phone, tablet etc), open your camera app or QR code scanner app.

## ACCESSING VIDEO GUIDES...

### 3. Scan QR code...



To scan the QR code, hold the camera over the QR code so that it can be seen on the screen. Once the QR code has been registered, follow the prompts on your device to open the video. (This will vary depending on your device.)

*Please note: Ensure to use the back camera of your smart device as this will scan the QR code more accurately.*

### 4. Watch the video...

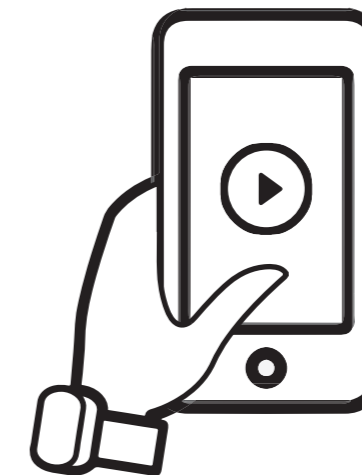

The video guide will now be displayed on your smart device.

**Disclaimer:** The garden building constructed in the video guides may be constructed differently to your building. Please ensure to read your instructions carefully to avoid error.

**Overall Dimensions:** Width = 2041mm  
 Depth = 2460mm  
 Height = 2059mm  
**Base Dimensions:** Width = 1864mm  
 Depth = 2386mm

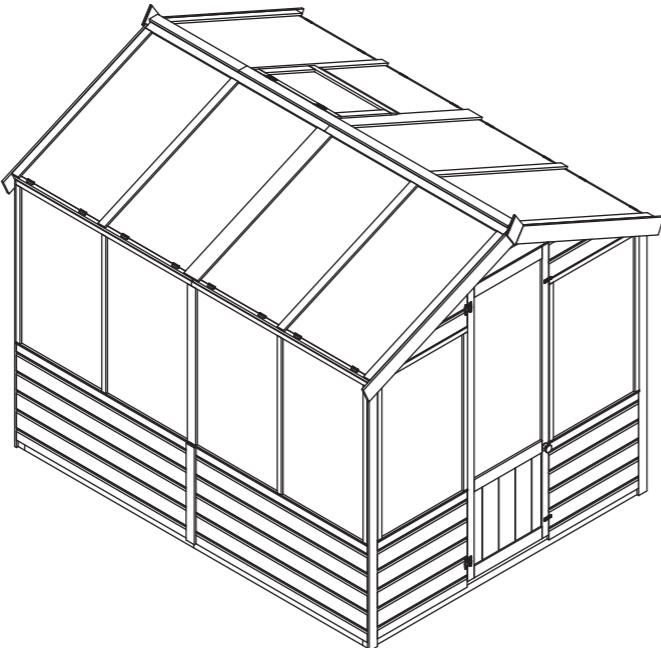

**Building Contents:**

Tip: Labelling your parts, using a pencil and masking tape, may help you to identify them easier when you need them.



1

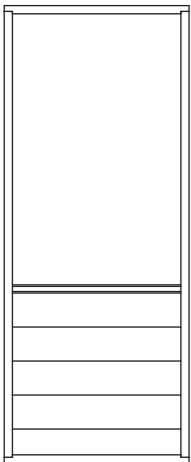

**Door Side QTY 2**  
 AI-04S21PCGP1W610X1543-V1

2



**Small Window Side QTY 4**  
 AI-04S21PCGP2W1193X1543-V1

3

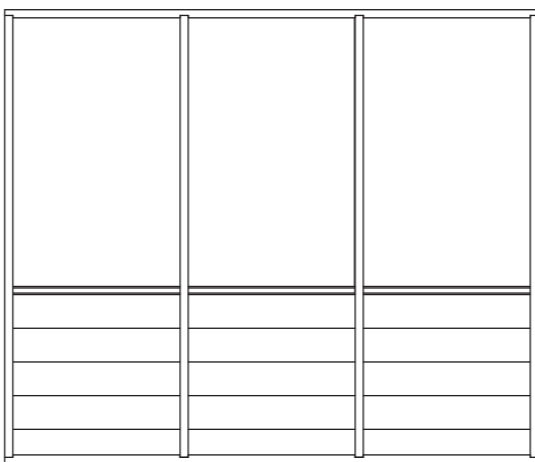

**Large Window Side**  
 AI-04S21PCGP3W1776X1543-V1

4

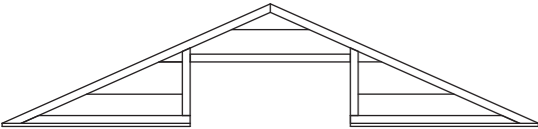

**Door Gable Top**  
 AI-S21SHASDGT1864X425-V1

5

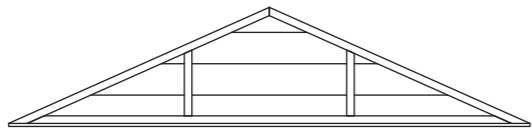

**Plain Gable Top**  
 AI-S21SHAGT1864X425-V1

6

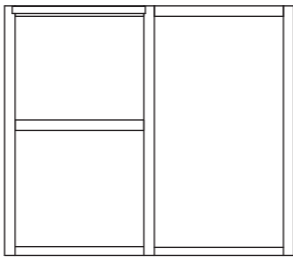

**Roof (Opening Window)**  
 AI-04S21GROPW3W1218X1037-V1

7

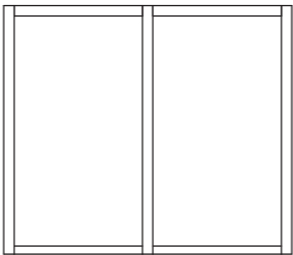

**Roof QTY 3**  
 AI-04S21GR2W1218X1037-V1

8

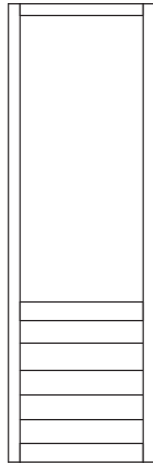

**Door**  
 AI-BSCHGPD550X1720-V1

9

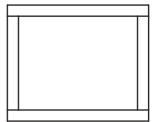

**Opening Window**  
 AI-FW560X460-V1

10

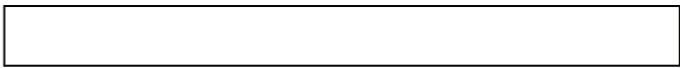

**Fascia - 12x95x1075mm QTY 4**  
 S1295-1075mm

11

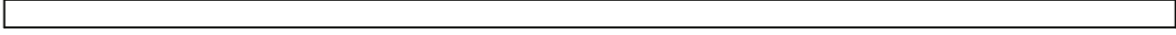

**Base Frame A - 44x44x1864mm QTY 2**  
 F4444-1864mm

12



**Base Frame B - 44x44x1149mm QTY 4**  
 F4444-1149mm

13

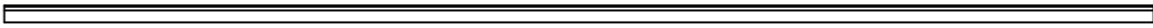

**Roof Support Bar 27x44x1829mm QTY 1**  
 F2744-1829mm (8mm lip, 2 x angled cuts)

14



**Roof Support Bar 27x44x607mm QTY 1**  
 F2744-607mm (8mm lip, 2 x angled cuts)

15

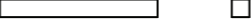

**Fascia Block - 28x28x251mm QTY 4**  
 FS2828-251mm

16







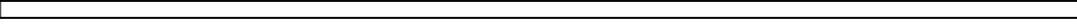



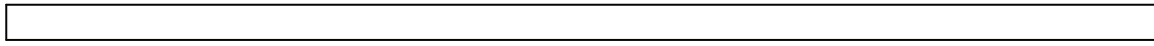
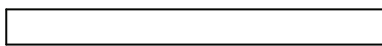

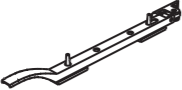

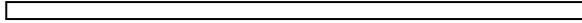
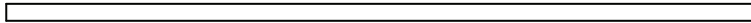
**Door Frame - 27x44x556mm QTY 1**  
 F2744-556mm

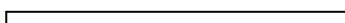
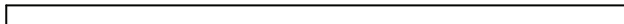
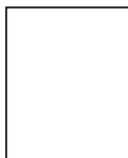
17



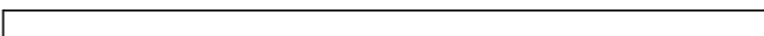
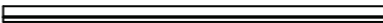
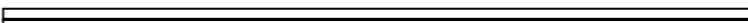

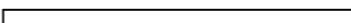
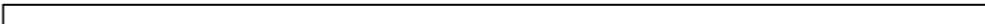
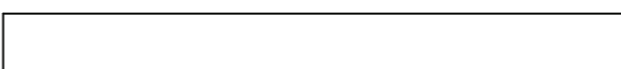

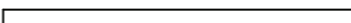



**Door Strip - 12x27x1717mm QTY 2**  
 S1227-1717mm

- 18**  *End View*  
**Short Door Strip - 12x27x556mm QTY 1**  
*S1227-556mm*
- 19**  *End View*  
**Roof Trim A - 12x56x1829mm QTY 1**  
*S1256-1829mm*
- 20**  *End View*  
**Roof Trim B - 12x56x607mm QTY 1**  
*S1256-607mm*
- 21**  **Butterfly Hinges QTY 4**  
*PI-07-0004*
- 22**  **Window Casement Stay QTY 1**  
*PI-07-0008*
- 23**  **Window Glazing Bead QTY 16**  
*PI-07-0063*
- 24**  **Finial QTY 2**  
*SHED DIAMOND FINIAL*
- 25**  **Door Knob QTY 1**  
*PI-04-0024*
- 26**  **Turn Button QTY 2**  
*PI-07-0182*
- 27**  *End View*  
**Window Strip - 12x27x926mm QTY 16**  
*S1227-926mm*
- 28**  *End View*  
**Window Strip - 12x27x1776mm QTY 1**  
*S1227-1776mm*
- 29**  *End View*  
**Window Strip - 12x27x1193mm QTY 4**  
*S1227-1193mm*
- 30**  *End View*  
**Window Strip - 12x27x610mm QTY 2**  
*S1227-610mm*
- 31**  *End View*  
**Strip - 12x44x543mm QTY 1**  
*S1244-543mm*
- 32**  *End View*  
**Strip - 12x44x993mm QTY 8**  
*S1244-993mm*
- 33**  **Styrene 942x570x2mm QTY 13**  
*PI-05-0151*
- 34**  **Styrene 503x570mm QTY 1**  
*PI-05-0158*
- 35**  **Styrene 985x570mm QTY 7**  
*PI-05-0157*

- 36**  *End View*  
**Strip - 12x44x1218mm QTY 4**  
*S1244-1218mm*
- 37**  *End View*  
**Window Cill 610mm QTY 2**  
*PI-08-0021*
- 38**  *End View*  
**Window Cill 1193mm QTY 4**  
*PI-08-0019*
- 39**  *End View*  
**Window Cill 1776mm QTY 1**  
*PI-08-0020*
- 40**  *End View*  
**Strip - 12x21x560mm QTY 1**  
*S1221-560mm*
- 41**  *End View*  
**Corner Trims - 12x56x1576mm QTY 4**  
*S1256-1576mm*
- 42**  *End View*  
**Strip - 12x95x993mm QTY 2**  
*S1295-993mm*
- 43**  *End View*  
**Strip - 12x56x926mm QTY 2**  
*S1256-926mm*
- 44**  *End View*  
**Strip - 12x56x570mm QTY 2**  
*S1256-570mm*

**Screw Pack:**

There may be extra screws in the pack.

-  **30mm Screw x 189**
-  **16mm Black Screws x 8**
-  **40mm Screw x 25**
-  **16mm Screws x 32**
-  **50mm Screw x 75**
-  **20mm Screw x 6**
-  **70mm Screw x 20**
-  **30mm Black Screw x 26**



### Missing parts?

Scan the QR code to visit our customer portal where you can quickly raise any missing or damaged parts and get a replacement sent out ASAP.



**Before assembly, please make sure you have a suitable base ready to install your building onto.**

#### Pre Assembly

Before assembling remove the transportation blocks from the bottom of each panel.

Take care removing the blocks as to not damage the panels. Tap with a flat headed screwdriver and hammer.

Dispose of the blocks once removed.

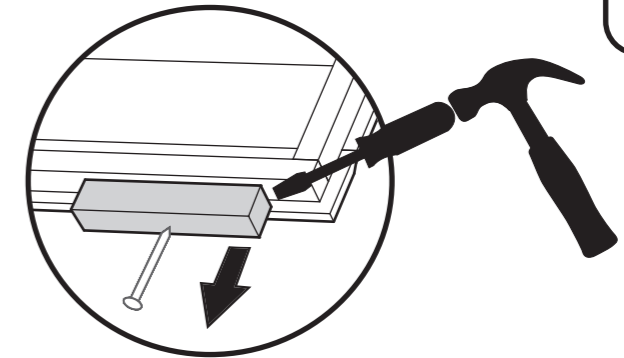

#### Step 1

**Parts needed - No. 11 QTY 2  
No. 12 QTY 4**

**IMPORTANT: Pre-drill before fixing screws.**

Lay the Base Frames (No. 11 & 12) down on a flat and level base. Ensure the framing is flush and level and that Base Frame B, sits on the inside of Base frame A, as shown.

Fix the base framing (No. 11 & 12) together using 2x70mm screws per corner and 2x70mm screws per join.

**12x70mm screws.**

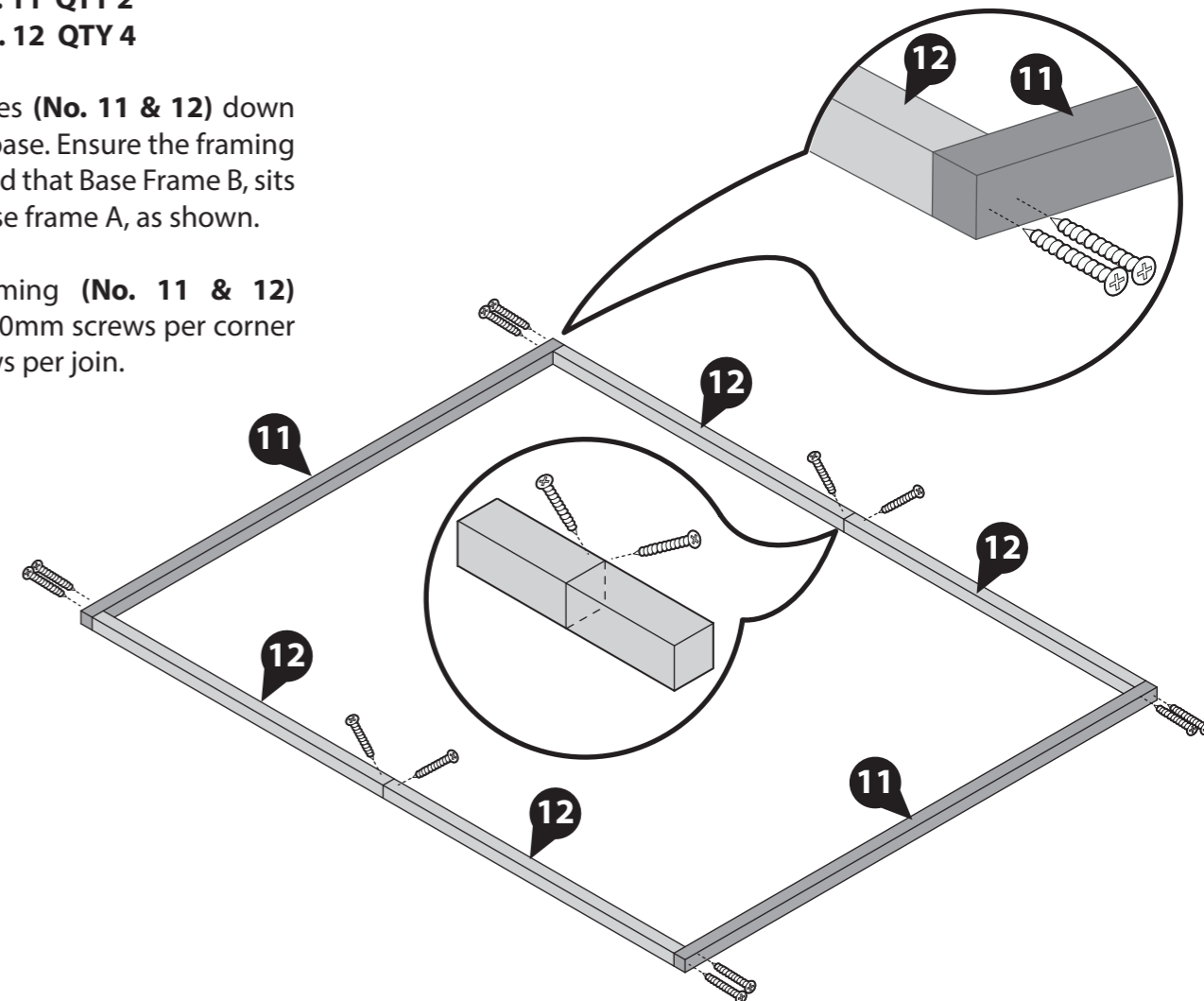

This greenhouse can be assembled along side the 4x6 apex shed (01DTSHAX0406SDFW-V2)

If you have purchased both these buildings, please follow the greenhouse assembly instructions from Step 1a on Page 17.

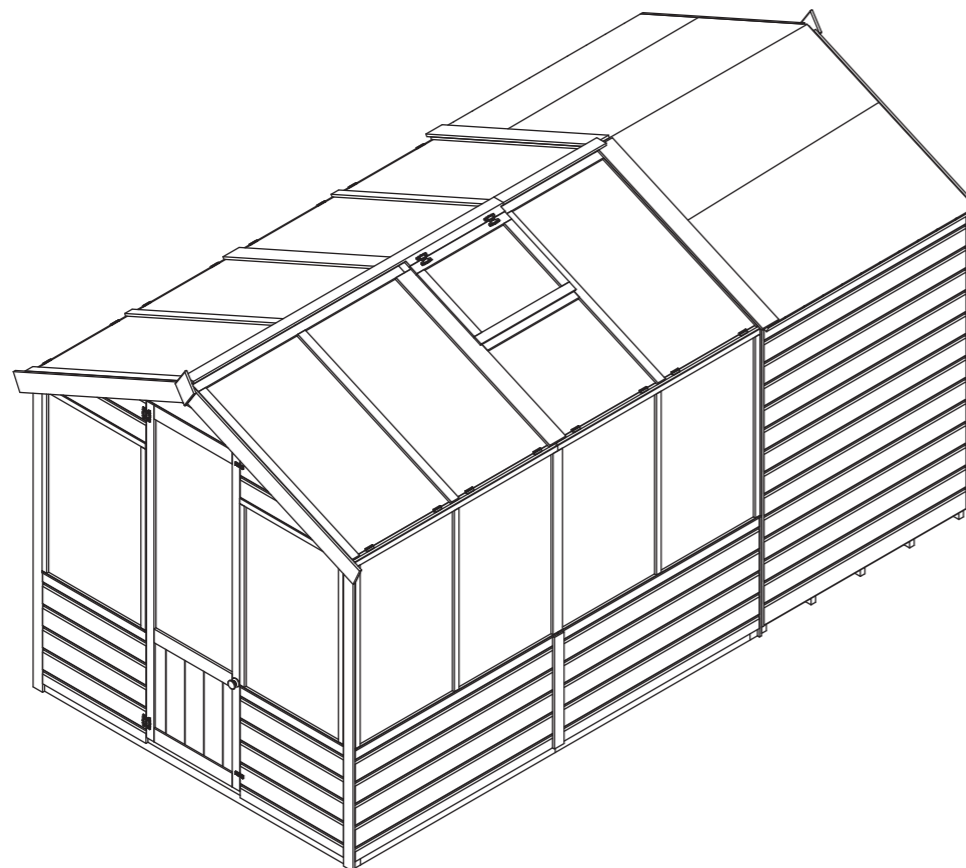

#### 12x6 Greenhouse with shed

##### Overall Dimensions:

Width = 2042mm  
Depth = 3665mm  
Height = 2039mm

##### Base Dimensions:

Width: 1860mm  
Depth: 3590mm

**IMPORTANT: Pre-drill before fixing screws.**

**Step 2**

<b>Parts needed - No. 1</b>	<b>QTY 2</b>	<b>No. 37</b>	<b>QTY 2</b>
<b>No. 2</b>	<b>QTY 4</b>	<b>No. 38</b>	<b>QTY 4</b>
<b>No. 3</b>	<b>QTY 1</b>	<b>No. 39</b>	<b>QTY 1</b>
<b>No. 33</b>	<b>QTY 13</b>		

- a** Lay the Door Sides (**No. 1**), Small Window Sides (**No. 2**) and Large Window Side (**No. 3**) down on a flat and level base.
- b** Place the Plastic Cills 610mm (**No. 37**) onto the lip of the external window opening of the Door sides (**No. 1**). Secure the Cill to the framing using 3x30mm screws.
- c** Place the Plastic Cills 1193mm (**No. 38**) onto the lip of the external window opening of the Small Window Sides (**No. 2**). Secure the Cill to the framing using 3x30mm screws.
- d** Place the Plastic Cill 1776mm (**No. 39**) onto the lip of the external window opening of the Large Window Sides (**No. 3**). Secure the Cill to the framing using 4x30mm screws.
- e** Place the styrene (**No. 33**) on top of the cills, ensuring there is equal spacing on all sides, as shown.

20x30mm screws.

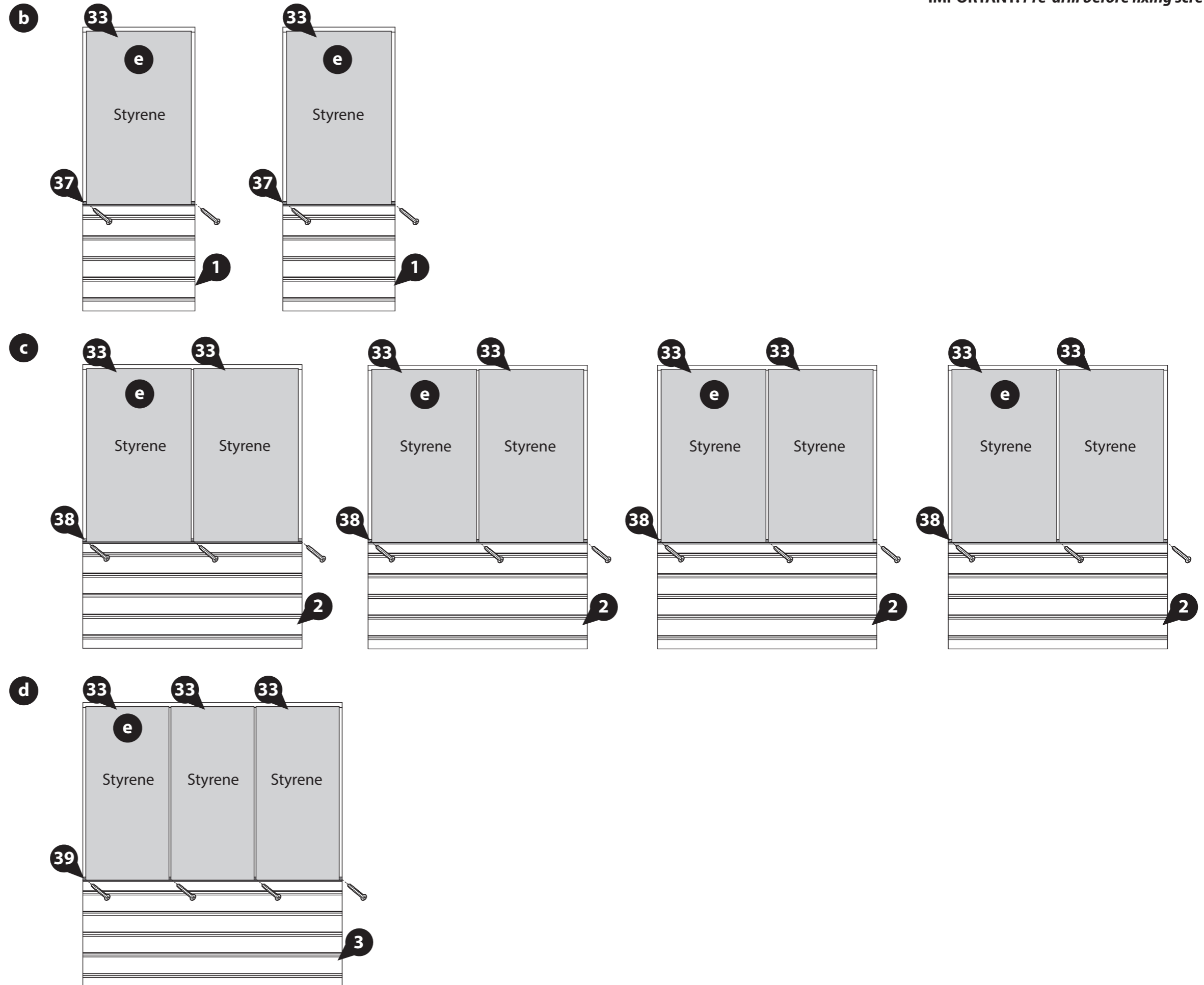
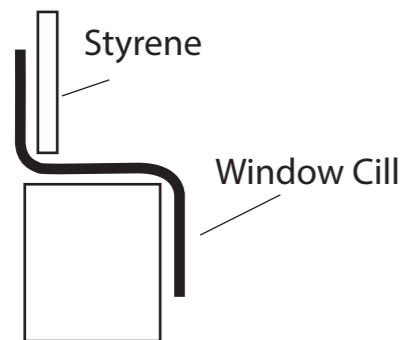
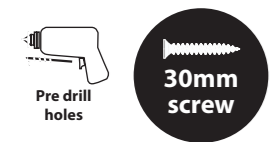

**IMPORTANT: Pre-drill before fixing screws.**

**Step 3**

- Parts needed - No. 27 QTY 16**  
**No. 28 QTY 1**  
**No. 29 QTY 4**  
**No. 30 QTY 2**

**a** On the Door sides (**No. 1**) locate Window strips (**No. 27**) onto either side of the panel and the Window Strips (**No. 30**) along the top of the panel, ensuring to trap the styrene. Fix in place using 3x30mm screw per strip.

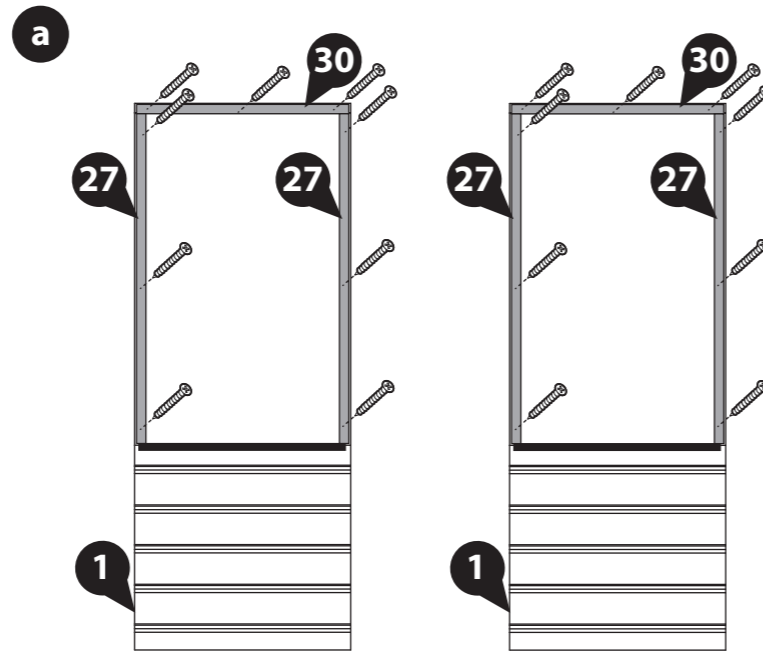

**b** On the Small Window Side (**No. 2**) locate Window strips (**No. 27**) onto one side of the panel, where the styrene joins and the Window Strip (**No. 29**) along the top of the panel, ensuring to trap the styrene.

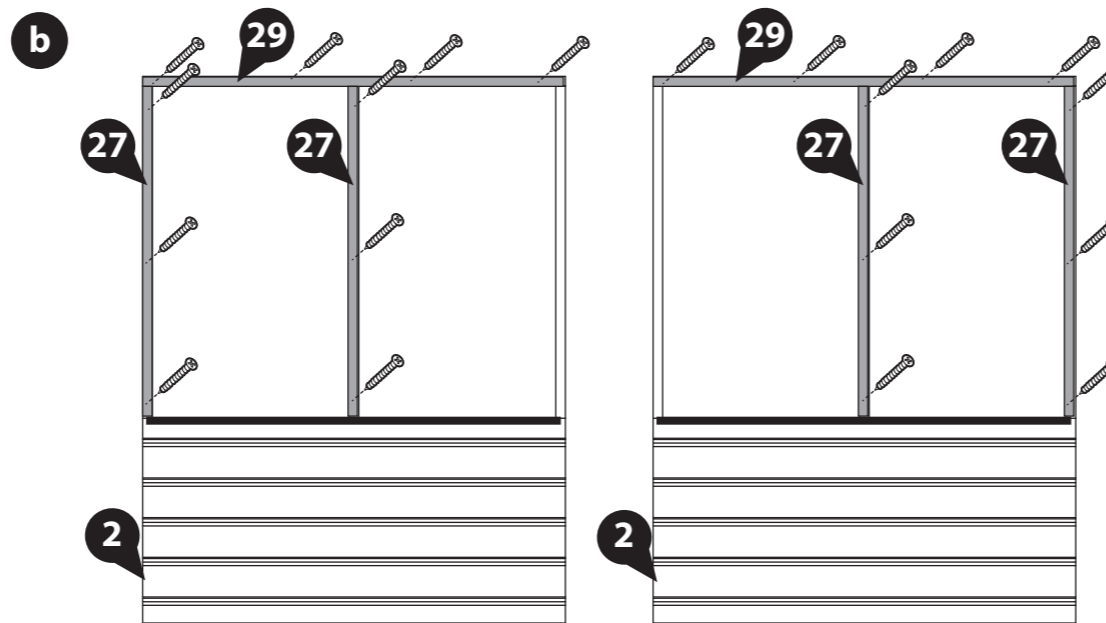

*Note: Working in pairs of panels, ensure to leave one side without a strip, as shown. This will be covered once the panels have been fixed together.*

Fix in place using 3x30mm screw per side strip and 4x30mm screws for the top strip.

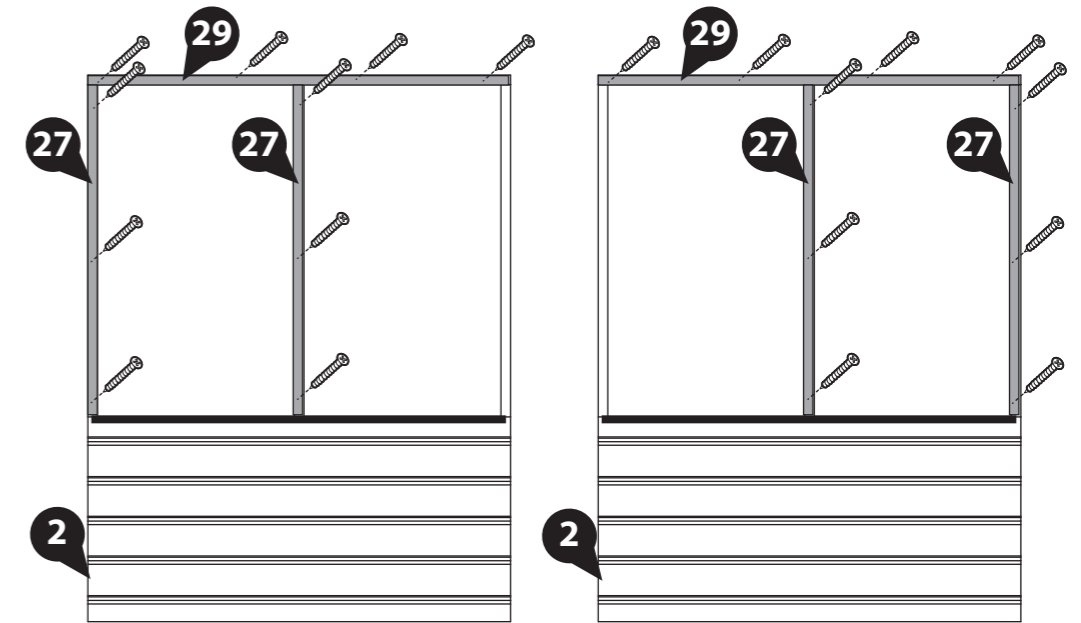

**c** On the Large Window Side (**No. 3**) locate Window strips (**No. 27**) onto either side of the panel, where the styrene joins and the Window Strip (**No. 28**) along the top of the panel, ensuring to trap the styrene. Fix in place using 3x30mm screw per side strip and 5x30mm screws for the top strip.

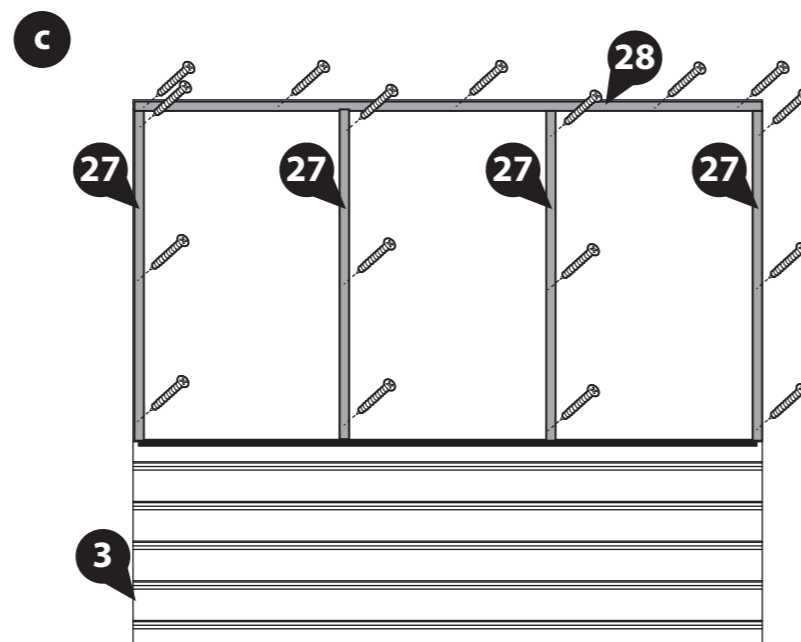

*Note: Ensure the framing does not protrude the width of the window frame.*

75x30mm screws.





**Step 4**  
Parts needed - No. 2 QTY 1  
No. 3 QTY 1

Locate the Small Window Side (No. 2) and the Large Window Side (No. 3) on top of the bearers at the corner, ensuring there is equal spacing between the panels and the base frame on each side.

**\*Note: The large window side sits in between the two side panels.\***

Secure the panels together by screwing through the corners using 3x50mm screws.

**DO NOT fix the panels to the floor until the roof has been fitted.**

3x50mm screws.

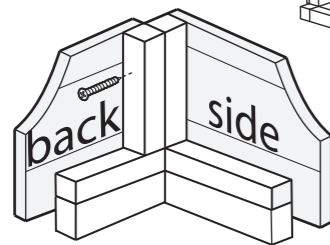

**IMPORTANT: Pre-drill before fixing screws.**

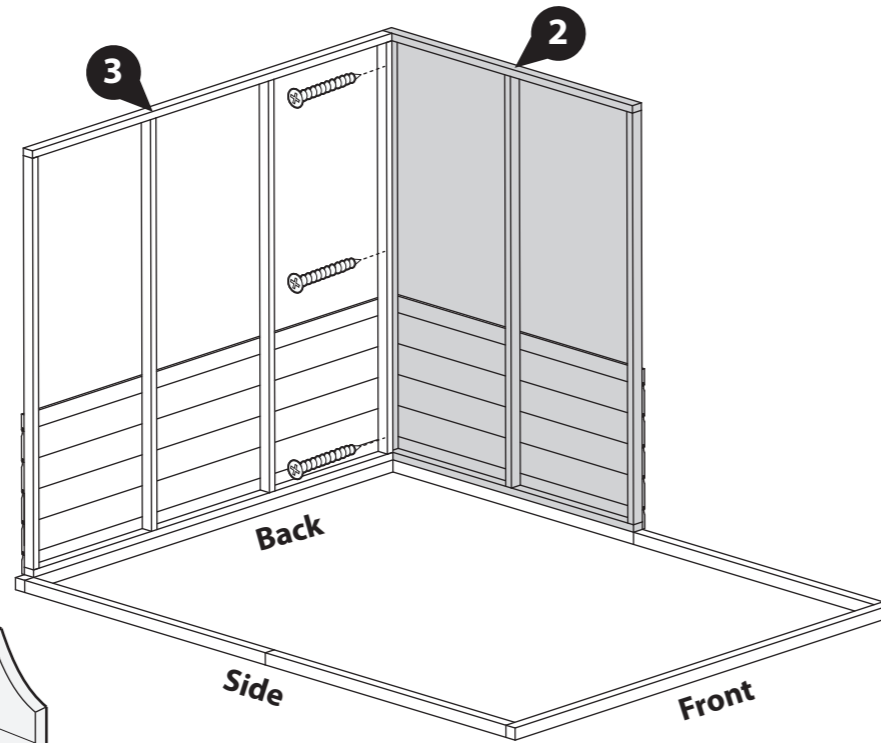

**Step 6**  
Parts needed - No. 2 QTY 1

Locate the remaining Small Window Side (No. 2) on top of the bearers, ensuring there is equal spacing between the panels and the base frame on each side.

**\*Note: The large window side sits in between the two side panels.\***

Secure the panels together by screwing through the framing using 3x50mm screws.

**DO NOT fix the panels to the floor until the roof has been fitted.**

3x50mm screws.

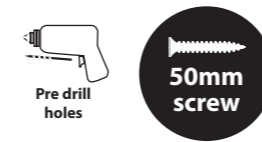

**IMPORTANT: Pre-drill before fixing screws.**

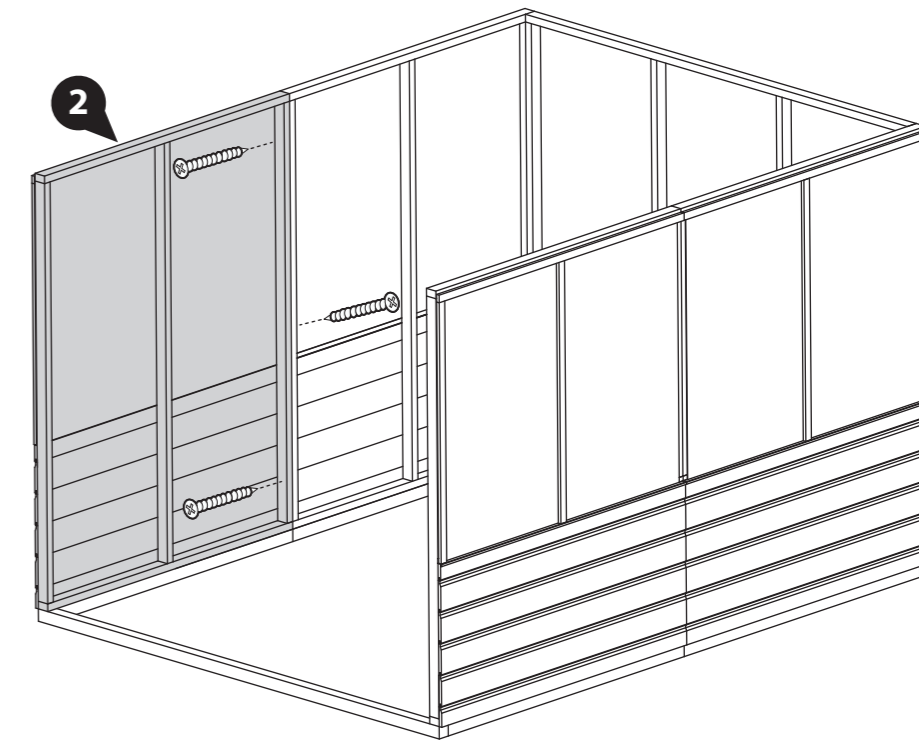

**Step 5**  
Parts needed - No. 2 QTY 2

Locate two Small Window Sides (No. 2) on top of the bearers, ensuring there is equal spacing between the panels and the base frame on each side.

**\*Note: The large window side sits in between the two side panels.\***

Secure the panels together by screwing through the panel framing using 3x50mm screws.

**DO NOT fix the panels to the floor until the roof has been fitted.**

6x50mm screws.

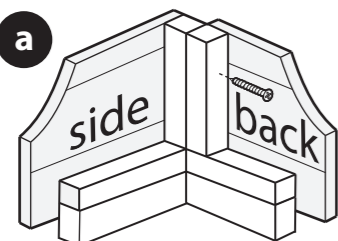

**IMPORTANT: Pre-drill before fixing screws.**

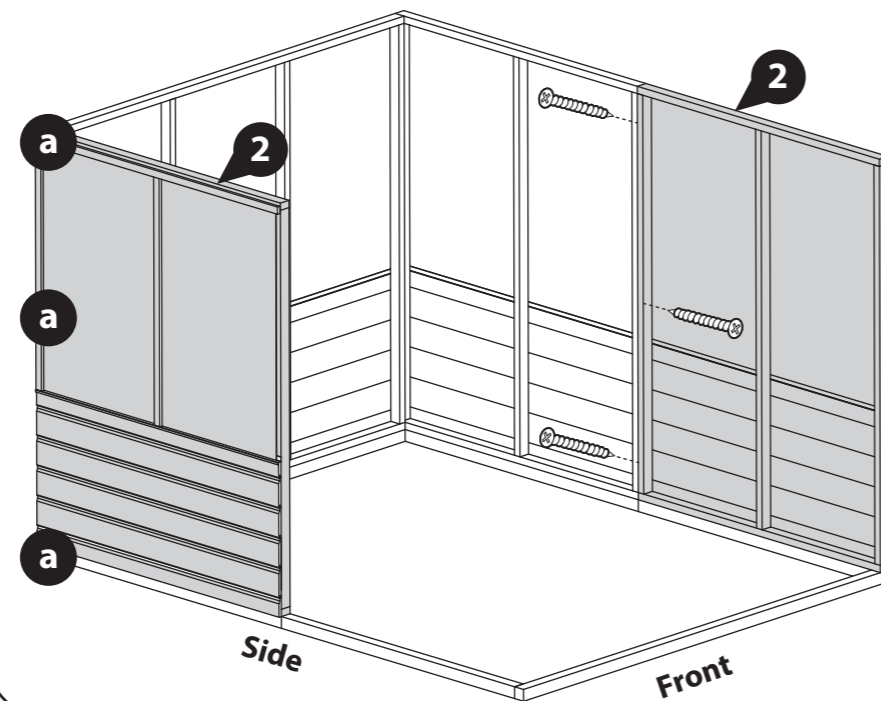

**Step 7**  
Parts needed - No. 1 QTY 2

Locate the Door Side (No. 1) on top of the bearers at the front corners, between the Small Window Sides (No. 2) ensuring there is equal spacing between the panels and the floor bearers on each side.

Secure the panels together by screwing through the corners using 3x50mm screws.

**DO NOT fix the panels to the floor until the roof has been fitted.**

6x50mm screws.

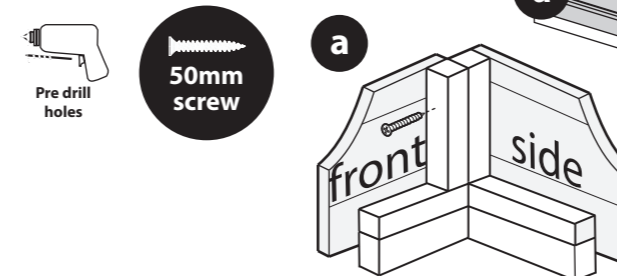

**IMPORTANT: Pre-drill before fixing screws.**

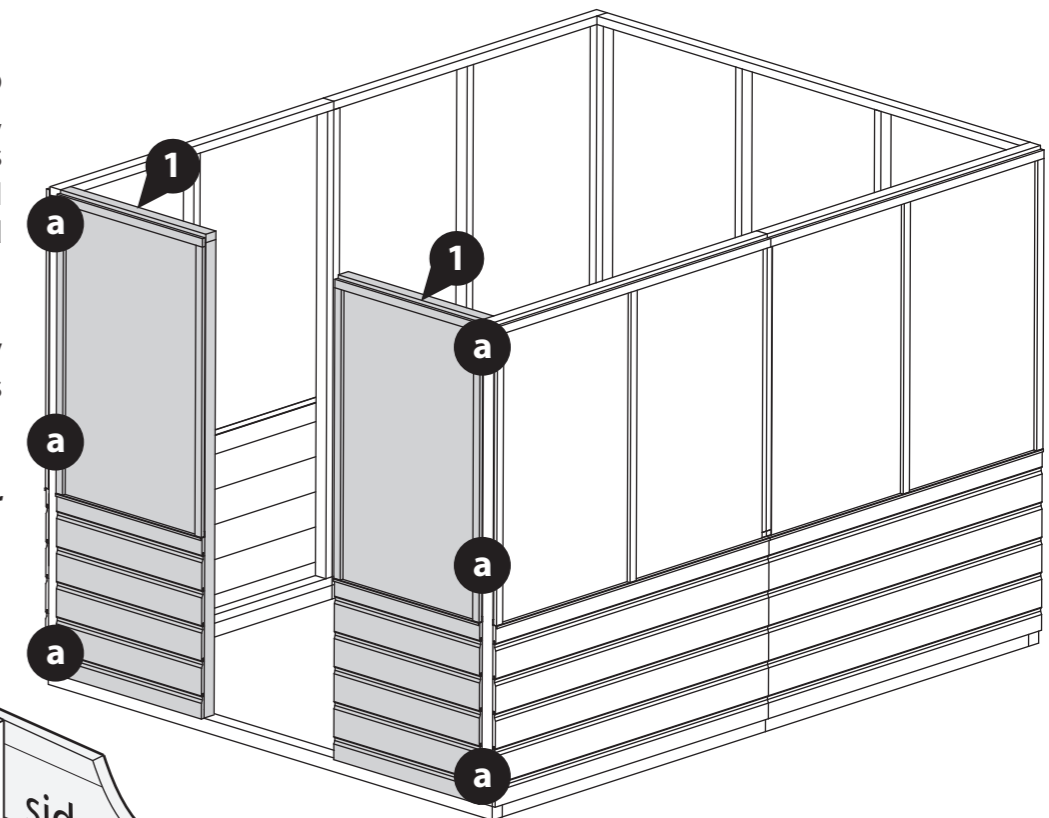

**Step 8**  
Parts needed - No. 16 QTY 1

Locate the Door Frame (No. 16) onto the base framing between the Door Sides (No. 1).

Fix in place using 3x40mm screws.

**3x40mm screws.**

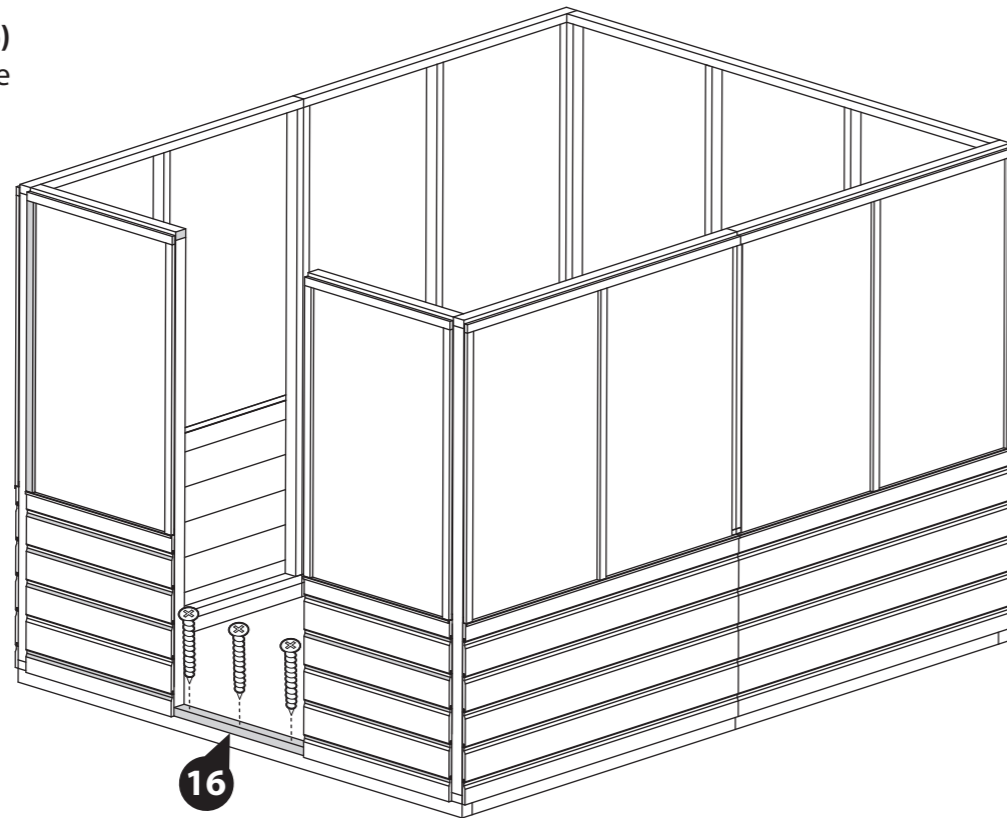
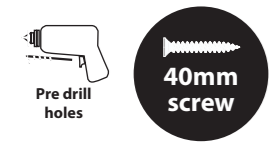

**IMPORTANT: Pre-drill before fixing screws.**

**Step 10**  
Parts needed - No. 4 QTY 1  
No. 5 QTY 1

Locate the Plain Gable Top (No. 5) on top of the Large Window Side and the Door Gable top (No. 4) on top of the Door Sides, as shown.

Secure the gables in place using 4x50mm screws per gable top, screwing through the panel framing into the gable framing above.

**8x50mm screws.**

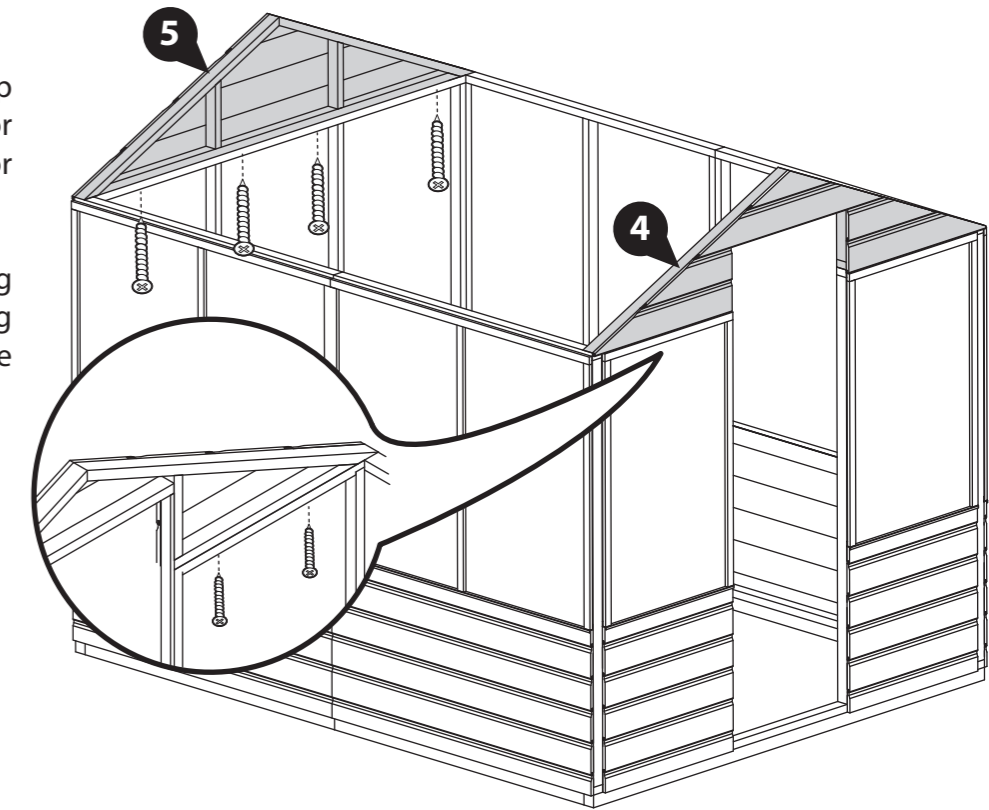

**IMPORTANT: Pre-drill before fixing screws.**

**Step 9**  
Parts needed - No. 43 QTY 2

Locate a Strip (No. 43) over the joining of the Small Window Panels (No. 2) on either side.

Fix in place using 4x30mm screws per strip.

**8x30mm screws.**

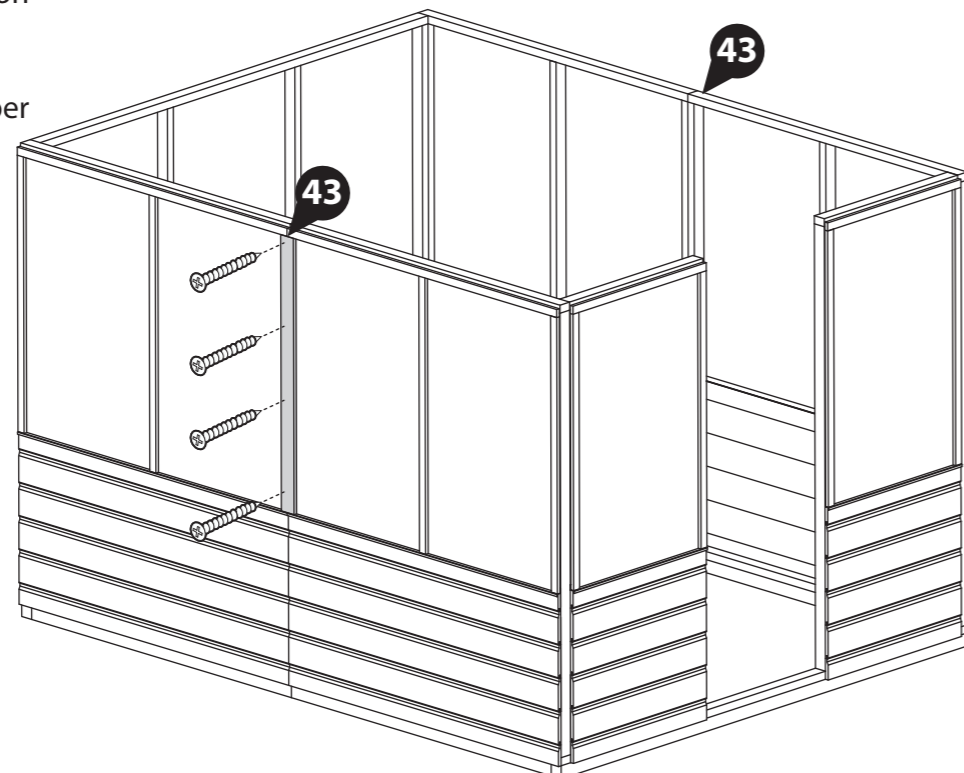
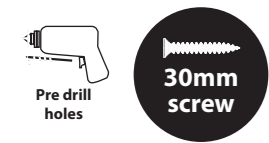

**IMPORTANT: Pre-drill before fixing screws.**

**Step 11**  
Parts needed - No. 17 QTY 2

Locate the two Door strips (No. 17) to either side of the door opening, ensuring the Strips are flush with the internal framing of the panel, as shown.

Fix in place using 3x30mm screws per strip.

**6x30mm Screws.**

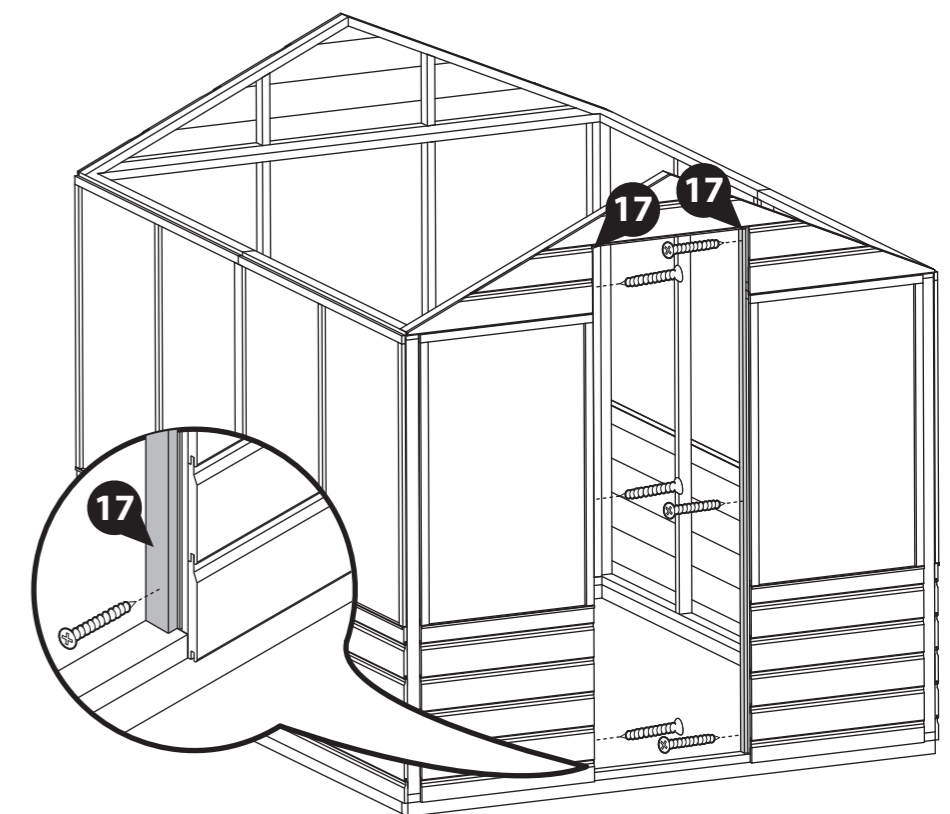
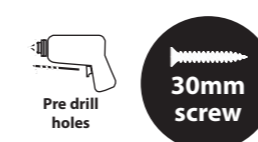

**IMPORTANT: Pre-drill before fixing screws.**

**Step 12**  
Parts needed - No. 18 QTY 1

Locate the Short Door strip (No. 18) to the top of the door opening.

Fix in place using 3x30mm screws.

**3x30mm Screws.**

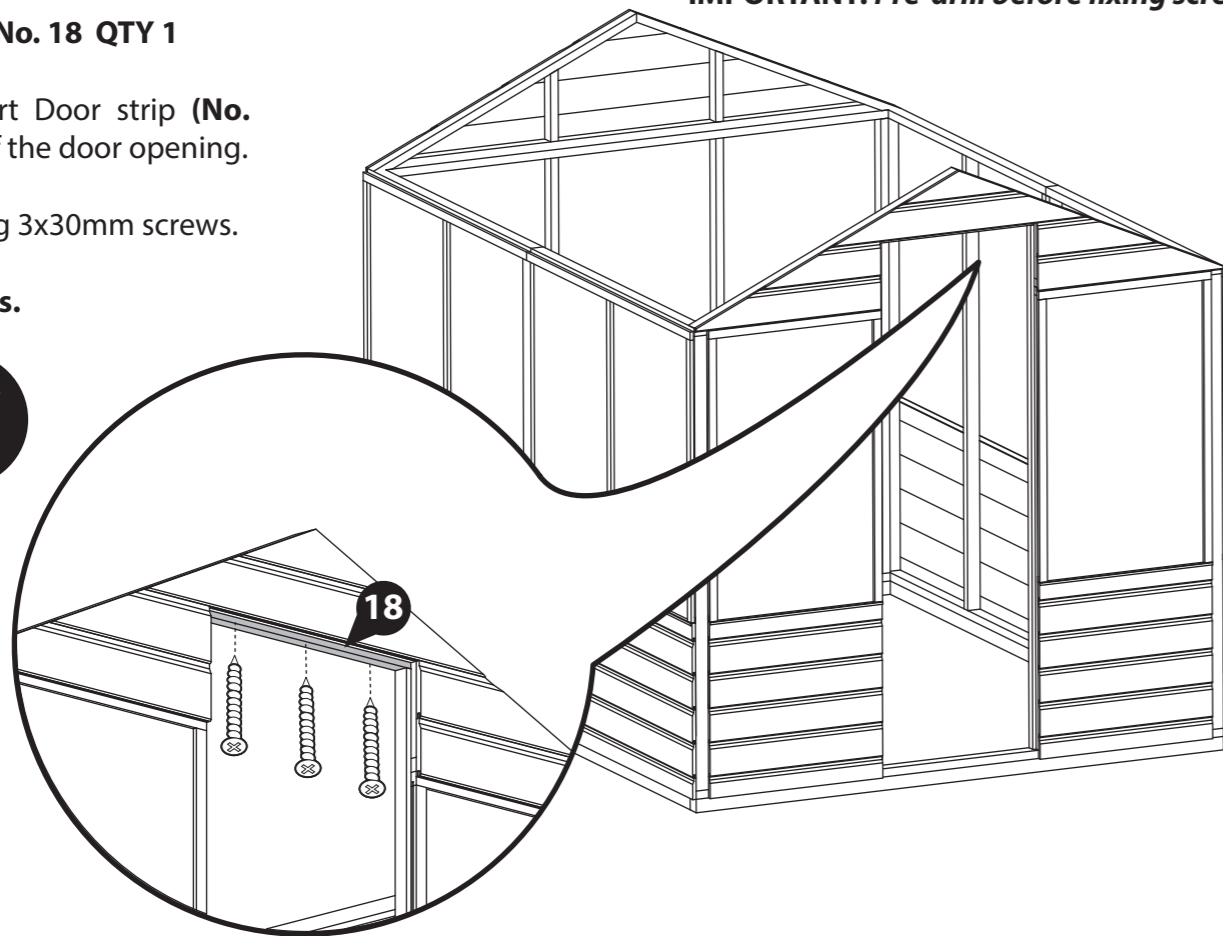

**Step 13**  
Parts needed - No. 15 QTY 4

Align the Fascia Blocks (No. 15) to the top edge of the Door Gable Top and fix in place using 2x50mm screws per block.

**8x50mm Screws.**

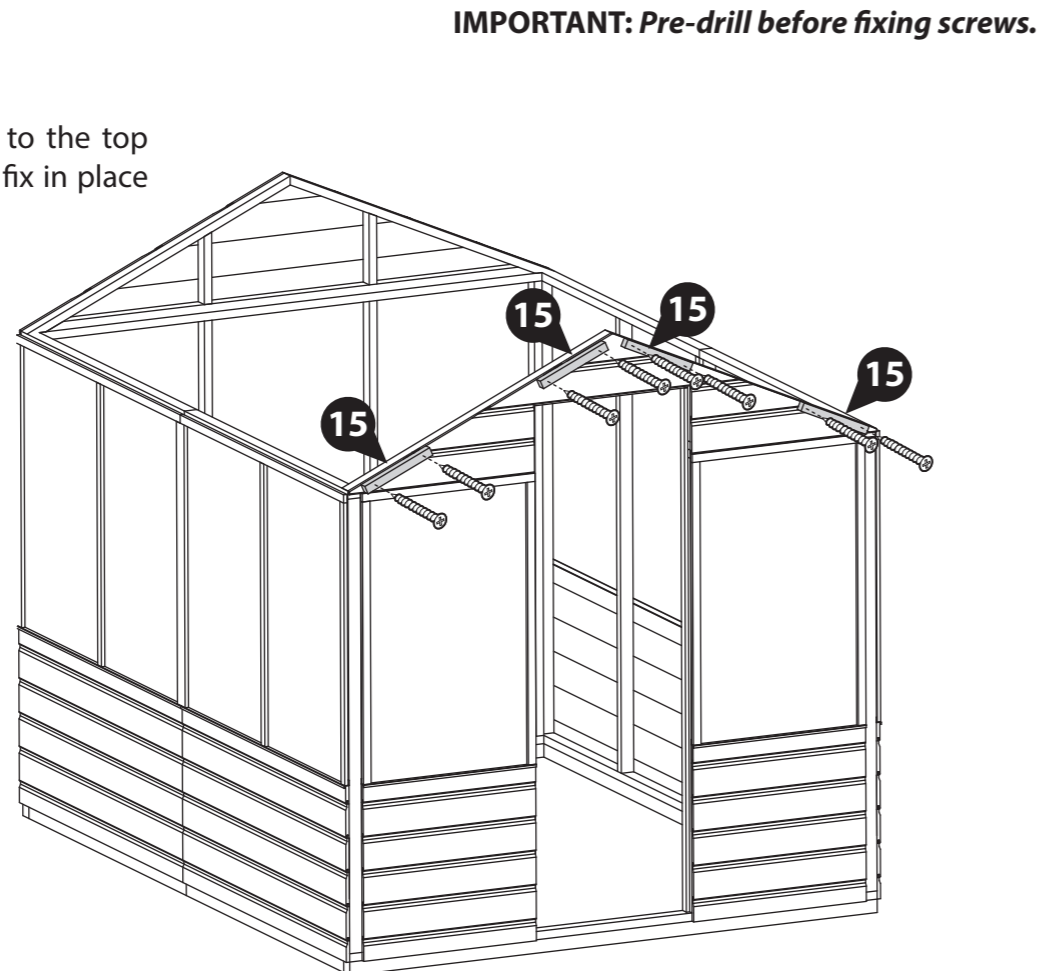

**Step 14**  
Parts needed - No. 6 QTY 1  
No. 23 QTY 4  
No. 34 QTY 1  
No. 35 QTY 1

Lay the roof panel (No. 6) down ensuring the thinner edge of the frame is at the bottom.

Apply a neat line of silicone sealant (not provided) along the panel framing. Place the styrene sheets (No. 34 & 35) in position as shown.

Fix in place using two Window Glazing beads (No. 23) per Styrene sheet. Evenly space the Window Glazing Beads before fixing. Screw down through the bead into the framing below using 2x16mm screws per bead.

**8x16mm Screws.**

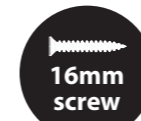

Sealant application gun

**IMPORTANT: Pre-drill before fixing screws.**

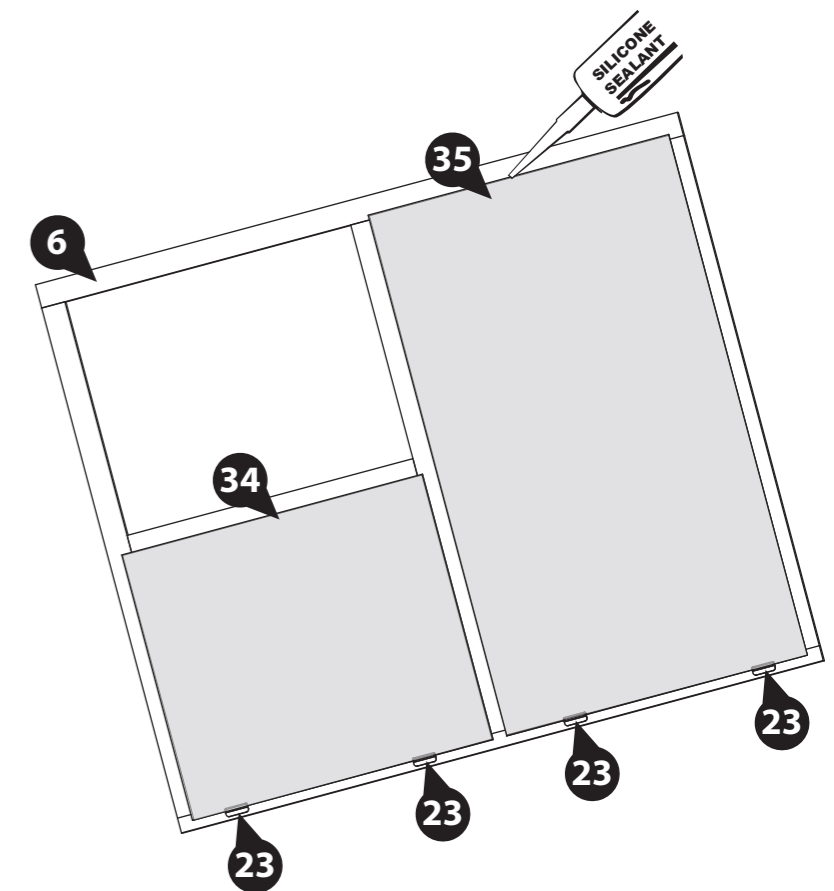

**Step 15**  
Parts needed - No. 31 QTY 1  
No. 32 QTY 2  
No. 36 QTY 1

Locate the strips (No 31, 32, & 36) onto the top of the Roof panel, ensure to trap the styrene and that the framing is flush to the edge of the panel and each strip, as shown.

Ensure to leave one side of the panel free from any strips, as this will be covered once attached to the other Roof panel.

Fix the strips in place using 3x30mm screws per strip. Ensure you screw to the side of the styrene not through it.

**12x30mm Screws.**

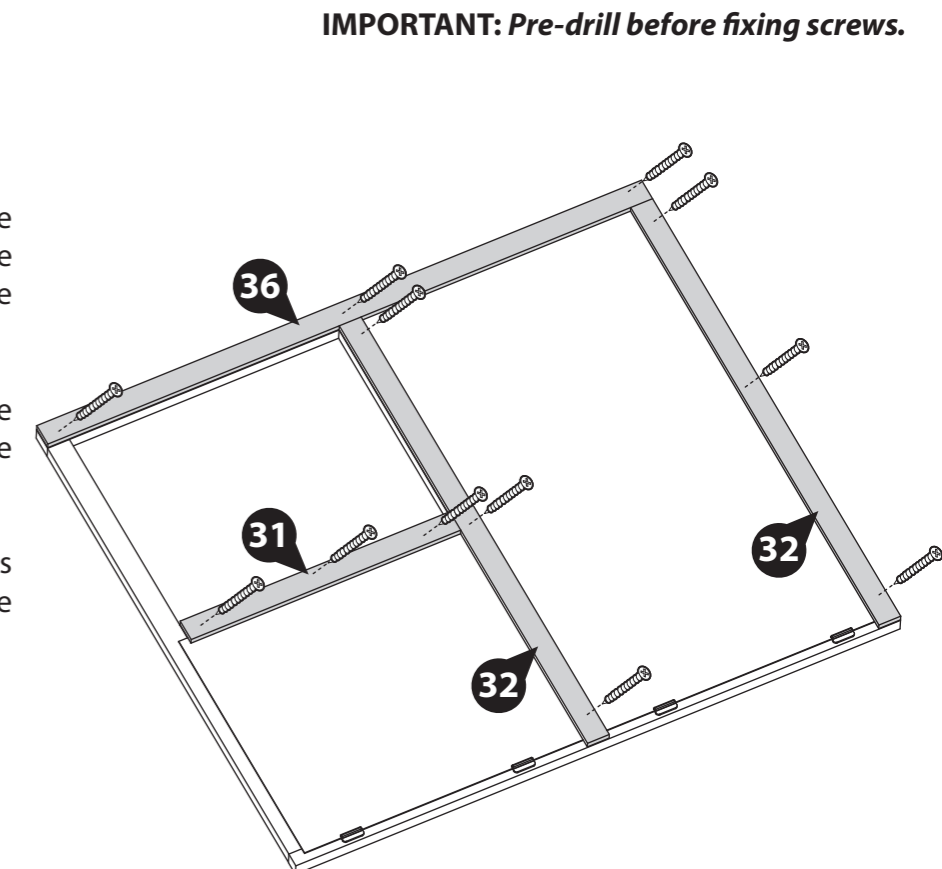
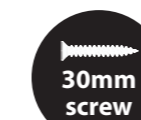
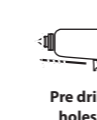

**Step 16**

**Parts needed - No. 9 QTY 1  
No. 21 QTY 2  
No. 40 QTY 1**

Locate the Opening Window (**No. 9**) into the Window aperture, ensuring equal spacing on all sides.

Locate the strip (**No. 40**) onto the window panel above the Window (**No. 9**) and fix in place with 4x30mm screws.

Locate the Hinges (**No. 21**) onto the Strip (**No. 40**) and Window (**No. 9**), as shown.

Secure in place using 4x16mm and 4x30mm black screws per hinge, as shown. Use the 16mm screws to secure the hinge to the opening window and 30mm securing into the strip.

**4x30mm Screws.  
8x30mm Black Screws.  
8x16mm Black Screws.**



**IMPORTANT: Pre-drill before fixing screws.**

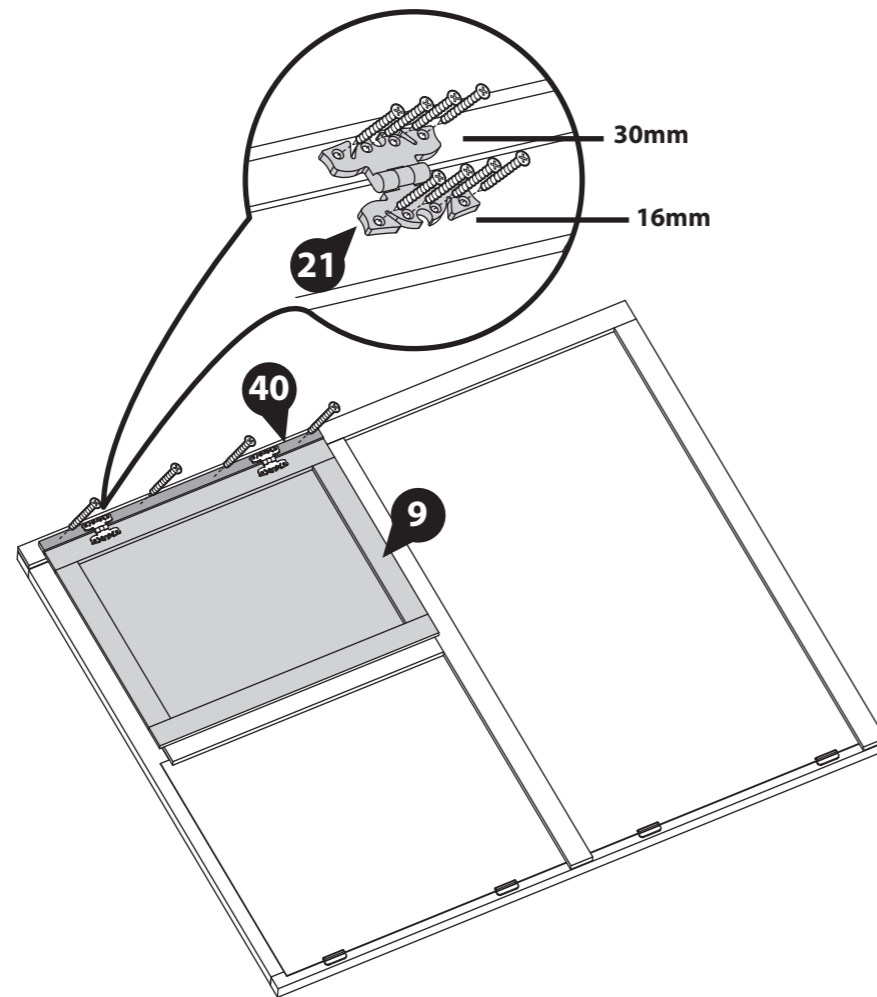

**Step 17**

**Parts needed - No. 7 QTY 3  
No. 23 QTY 12  
No. 35 QTY 6**

Lay the Roof Panels (**No. 7**) down ensuring the thinner edge of the frame is at the bottom.

Apply a neat line of silicone sealant (not provided) along the panel framing. Place the styrene sheets (**No. 35**) in position as shown.

Fix in place using two Window Glazing beads (**No. 23**) per Styrene sheet. Evenly space the Window Glazing Beads before fixing. Screw down through the bead into the framing below using 2x16mm screws per bead.

**Repeat for all three Roof Panels.**

**24x16mm Screws.**

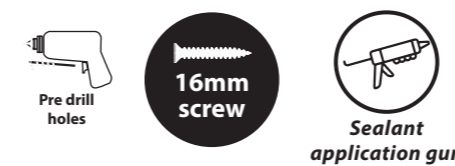

**IMPORTANT: Pre-drill before fixing screws.**

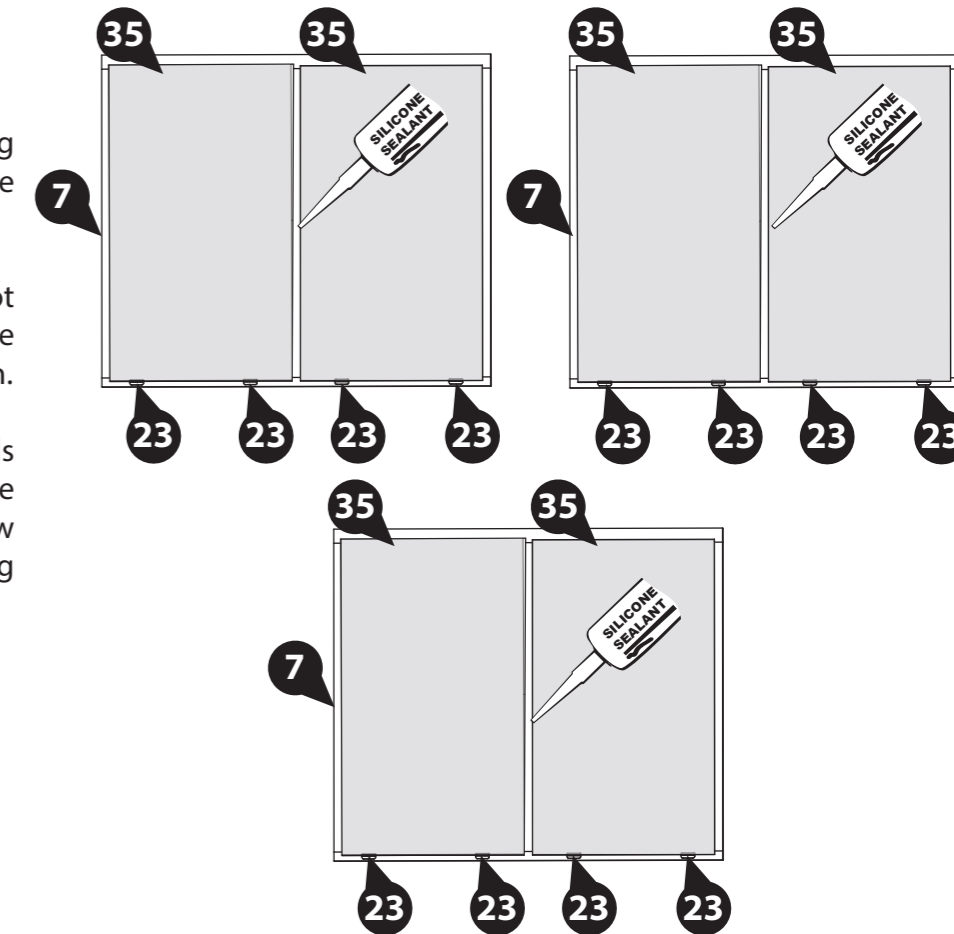

**IMPORTANT: Pre-drill before fixing screws.**

**Step 18**

**Parts needed - No. 32 QTY 6  
No. 36 QTY 3**

Locate the strips (**No. 32 & 36**) onto the top of the Roof panel, ensure to trap the styrene and that the framing is flush to the edge of the panel and each strip, as shown.

Do not fit strips on the inside of the roof panels which will sit next to another roof panel, see illustration.

Fix the strips in place using 3x30mm screws per strip. Ensure you screw to the side of the styrene not through it.

**Repeat for all three Roof Panels.**

**27x30mm Screws.**

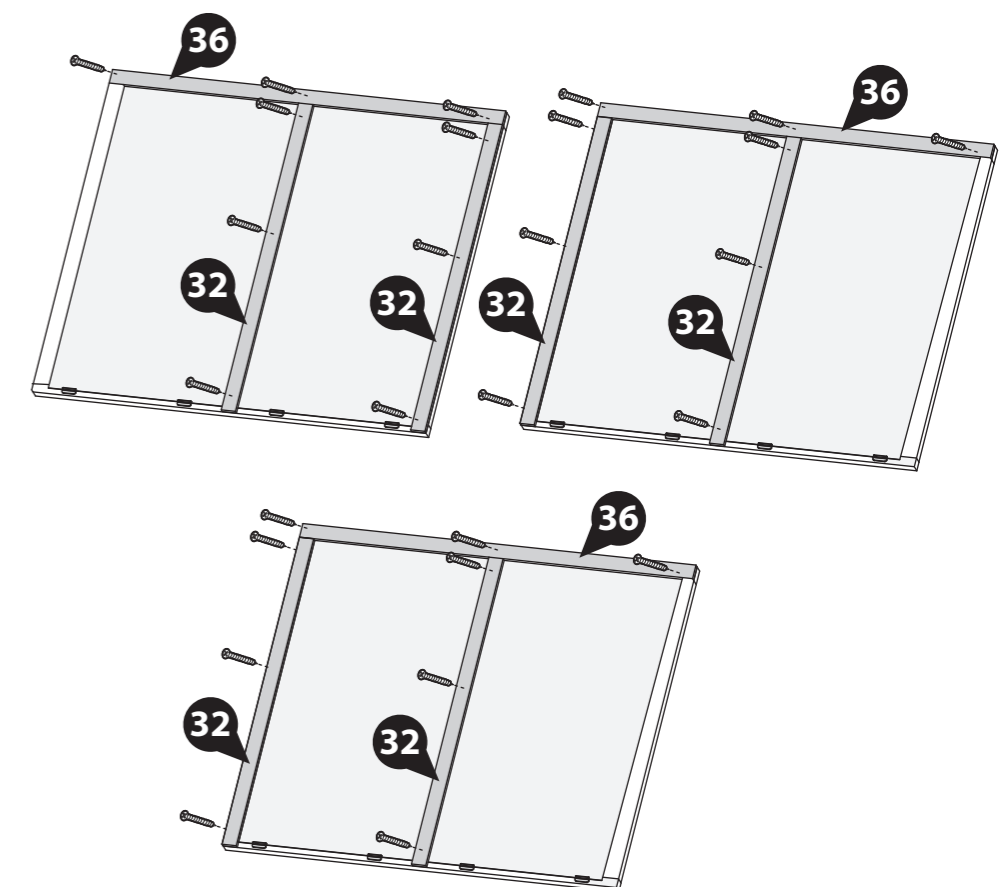
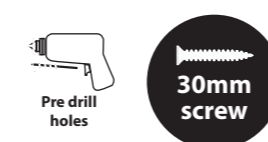

**Step 19**

Parts needed - No. 6 QTY 1  
No. 7 QTY 3

Place the assembled Roof panels (No. 6 & 7) on top of each gable, making sure the roofs are flush to each gable and meet at the top of the apex.

**\*IMPORTANT: Ensure both roof sections meet at the top of the apex as shown in the illustration.**

Fix the roof panels together from the inside of the greenhouse in the middle using 4x70mm screws.

Secure the roof panels to the building using 8x50mm screws per end.

16x50mm Screws.  
8x70mm Screws.

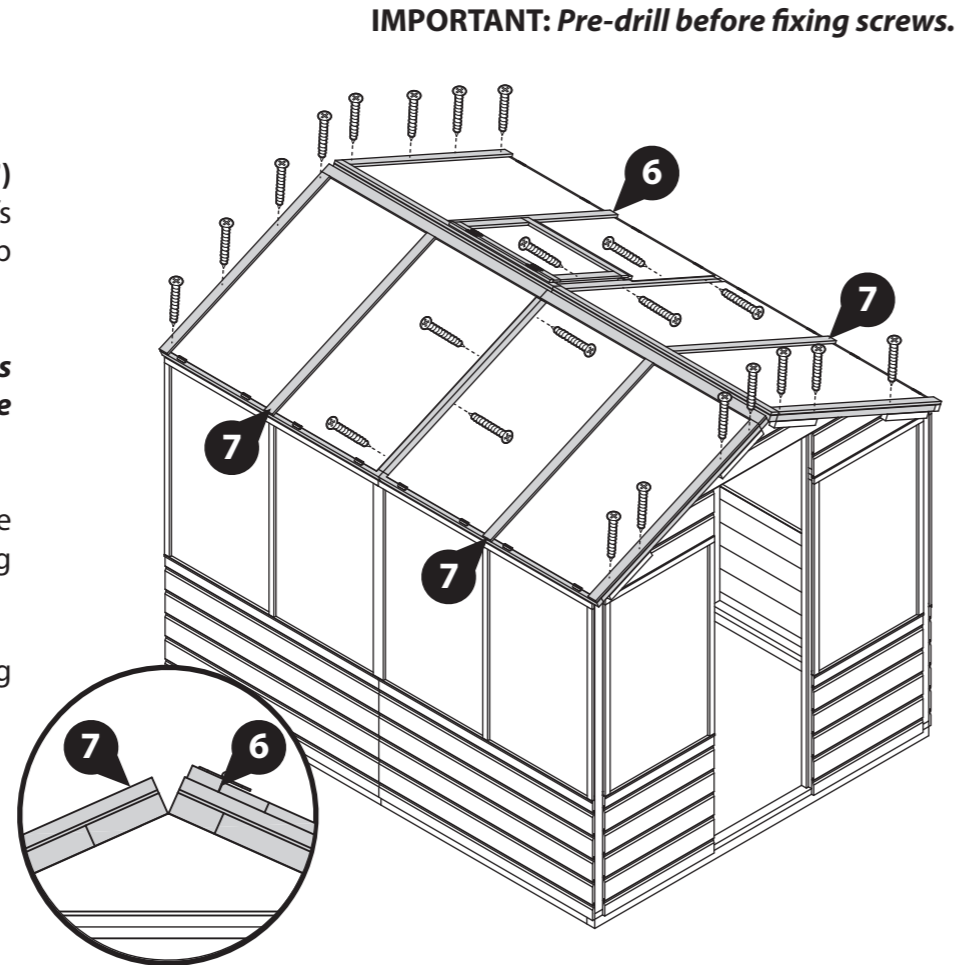

**Step 21**

Parts needed - No. 13 QTY 1  
No. 14 QTY 1

Attach the Roof Support bars (No. 13 & 14) to the roof panels using 6x40mm screws.

Screw diagonally through the support into the roof panel as shown in the diagram.

6x40mm Screws.

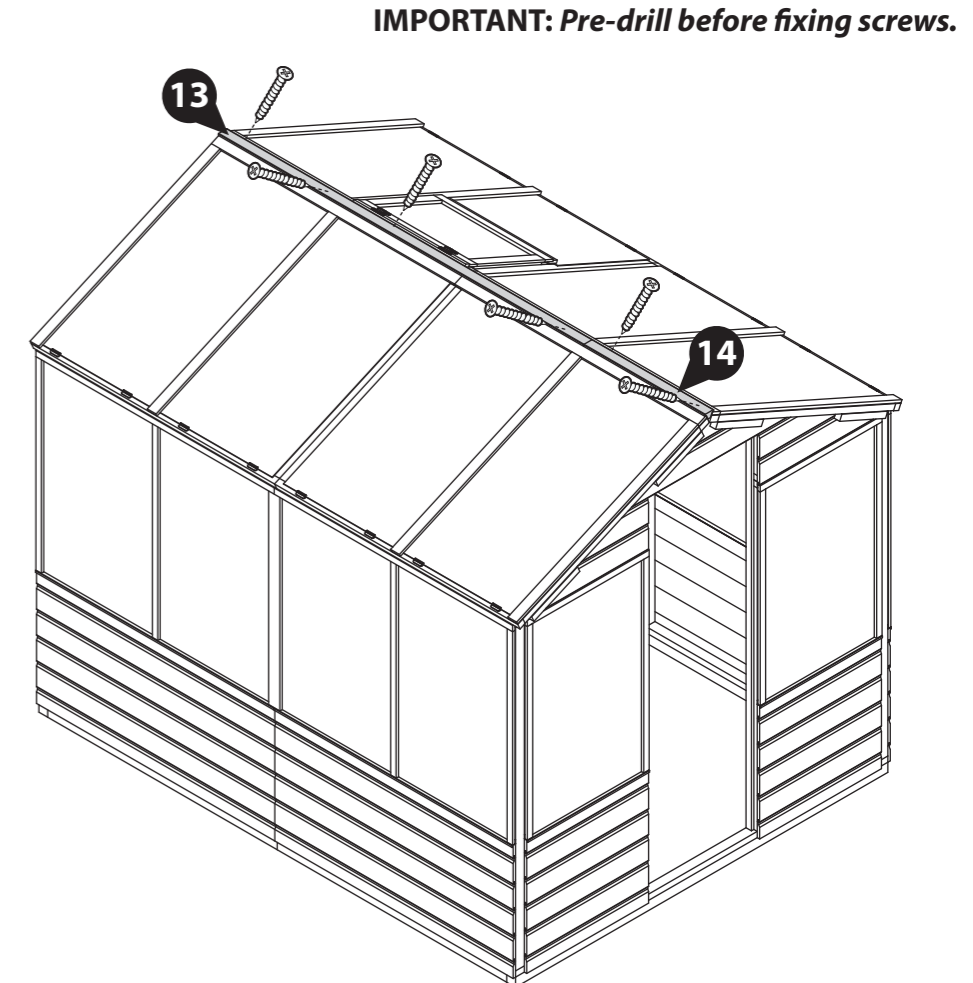

**Step 20**

Once the roof is fixed, the building can be secured to the base framing with 6x50mm screws per side.

24x50mm Screws.

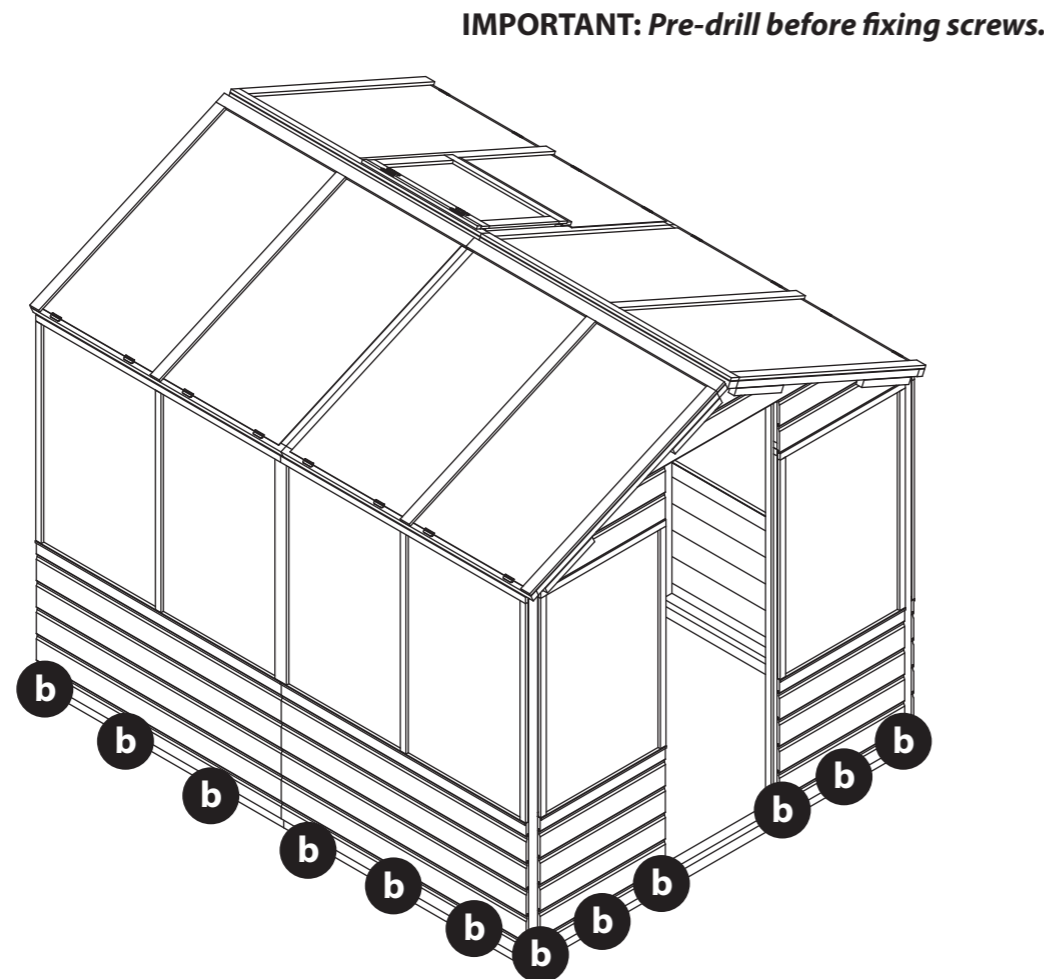
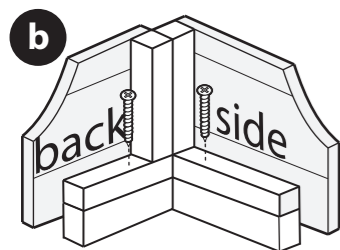

**Step 22**

Parts needed - No. 42 QTY 2

Fix strip (No. 42) to the roofs to cover the panel joins using 4x30mm screws per strip.

8x40mm Screws.

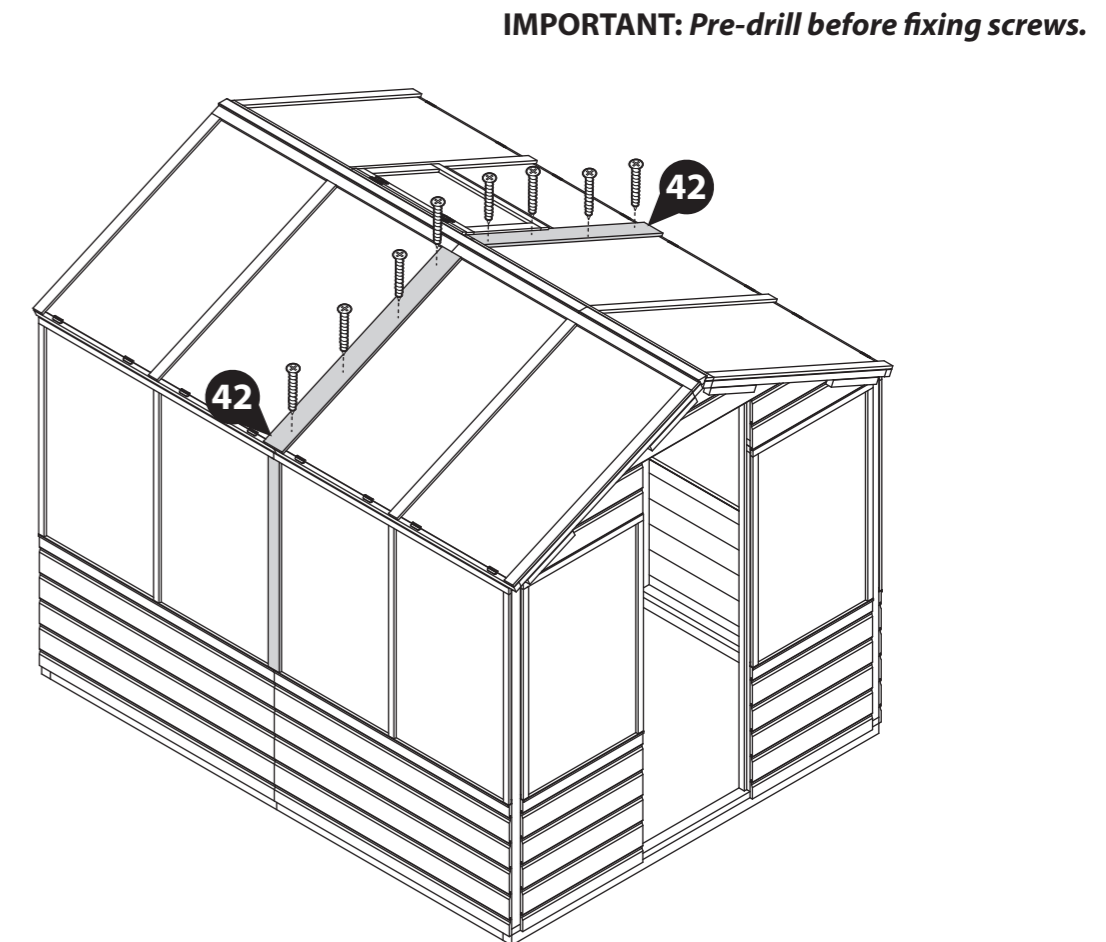
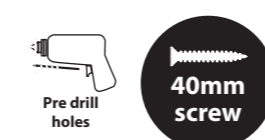

**Step 23**  
Parts needed - No. 22 QTY 1

Fix the Casement stay (No. 22) to the opening window then align the fixings onto the window panel frame. Ensure the casement stay fits onto fixings when closed before screwing them down using 6x20mm screws.

6x20mm Screws.

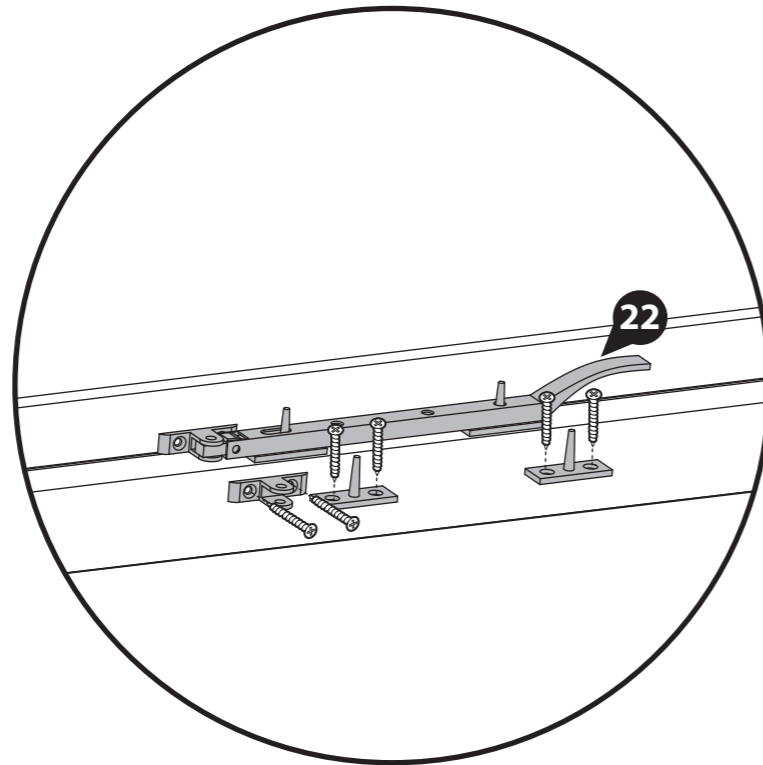

**IMPORTANT: Pre-drill before fixing screws.**

**Step 24**  
Parts needed - No. 8 QTY 1  
No. 21 QTY 2  
No. 25 QTY 1  
No. 26 QTY 2

- a** Locate the Door (No. 8) into the Door opening ensuring there is equal spacing on all sides.
- b** Fix the door (No. 8) to the building using 8x30mm black screws per hinge (No. 21) as shown in the diagram.
- c** Locate the Door Knob (No. 25) onto the door (No. 8). Secure in place by screwing through the door, internally, and into the door knob using 1x50mm screw.
- d** Locate one Turn Button (No. 26) to the top of the door and one to the bottom. Fix to the Door Side using 2x30mm black screws.

18x30mm Black Screws.  
1x50mm screw.



**IMPORTANT: Pre-drill before fixing screws.**

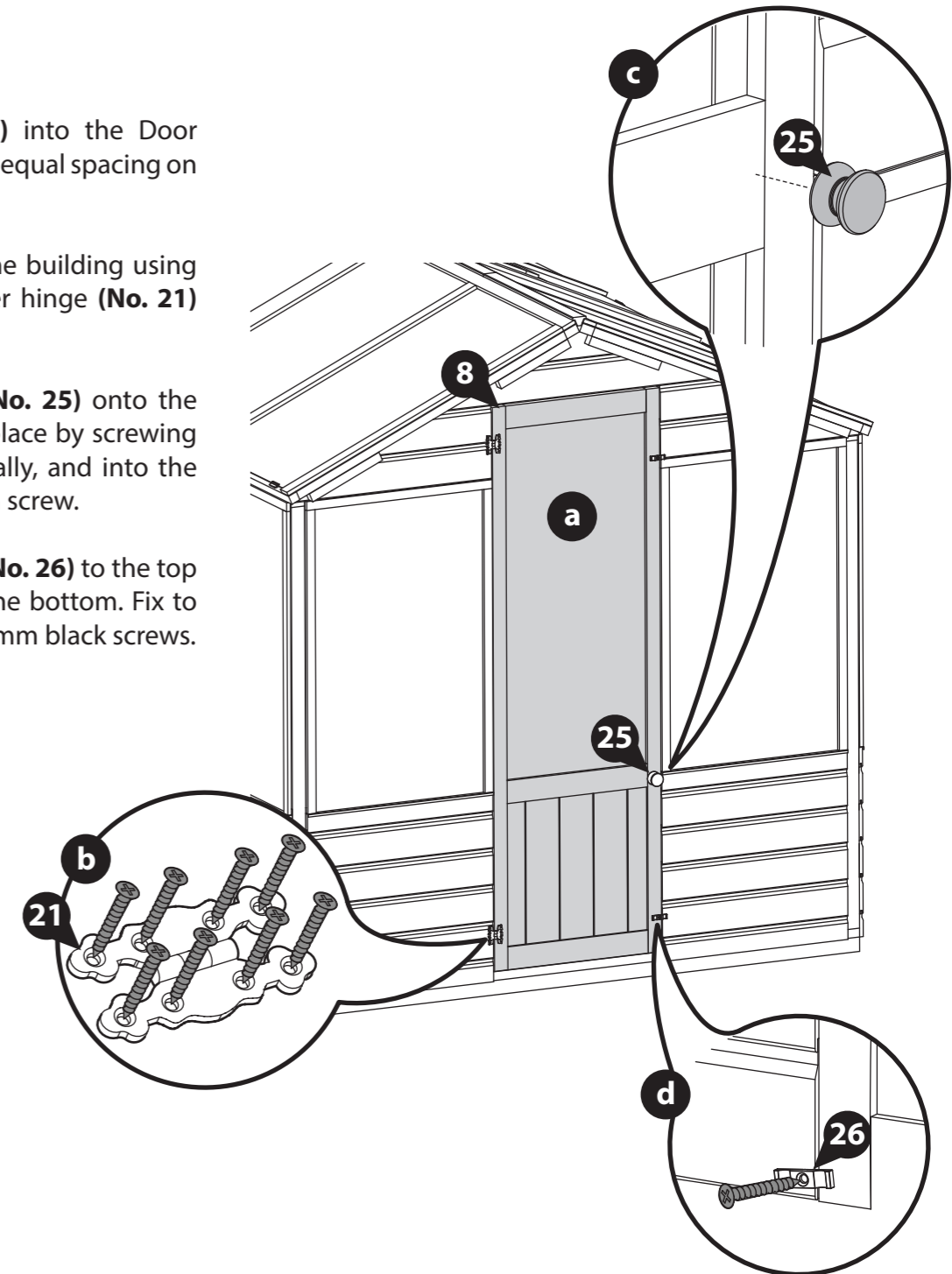

**Step 25**  
**Parts needed - No. 41 QTY 4**  
**No. 44 QTY 2**

Locate the Corner Trims (**No. 41**) onto each corner of the building, as shown.

Fix in place using 4x30mm screws per trim.

Locate the strips (**No. 44**) onto the joins of the small window panels on each side, as shown.

Fix in place using 3x30mm screws per trim.

**22x30mm Screws**

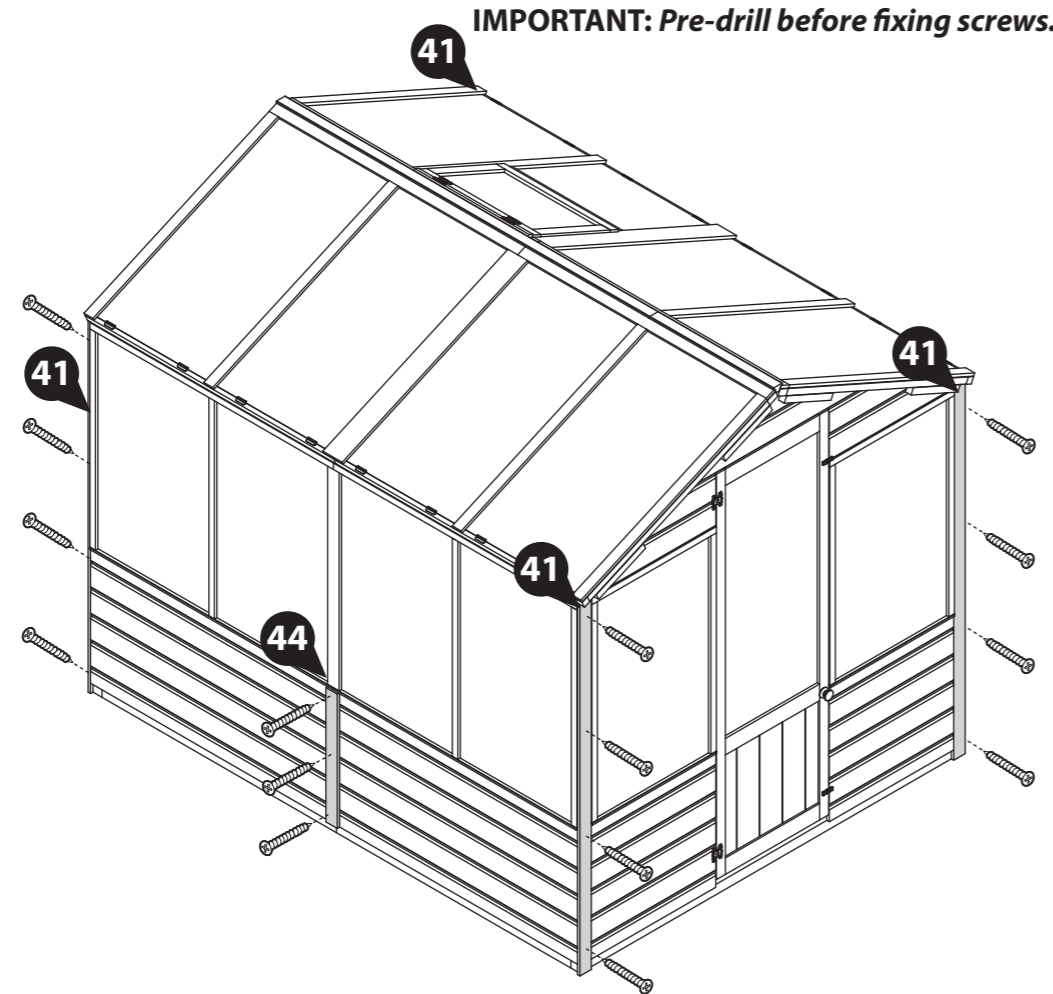

**Step 26**  
**Parts needed - No. 10 QTY 4**  
**No. 24 QTY 2**

Locate Fascias (**No. 10**) to the front and back of the building as shown. Secure in place using 3x30mm screws per Fascia.

Locate the finials (**No. 24**) on top of the Fascias (**No. 10**) and fix in place using 1x30mm screws per Finial.

**14x30mm Screws**

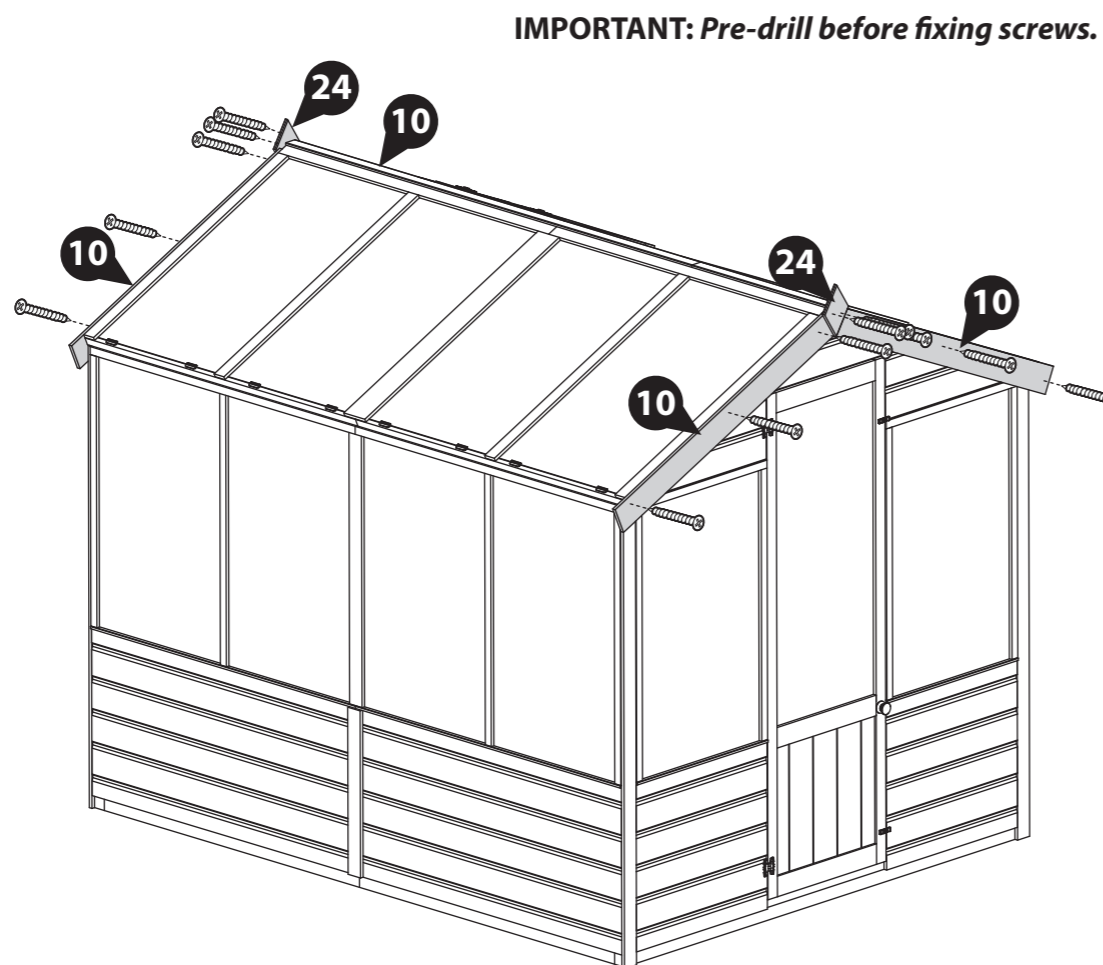

**Step 27**  
**Parts needed - No. 19 QTY 1**  
**No. 20 QTY 1**

Locate the Roof trims (**No. 19 & 20**) to the top of the building and secure with 6x30mm screws as shown.

**6x30mm Screws**

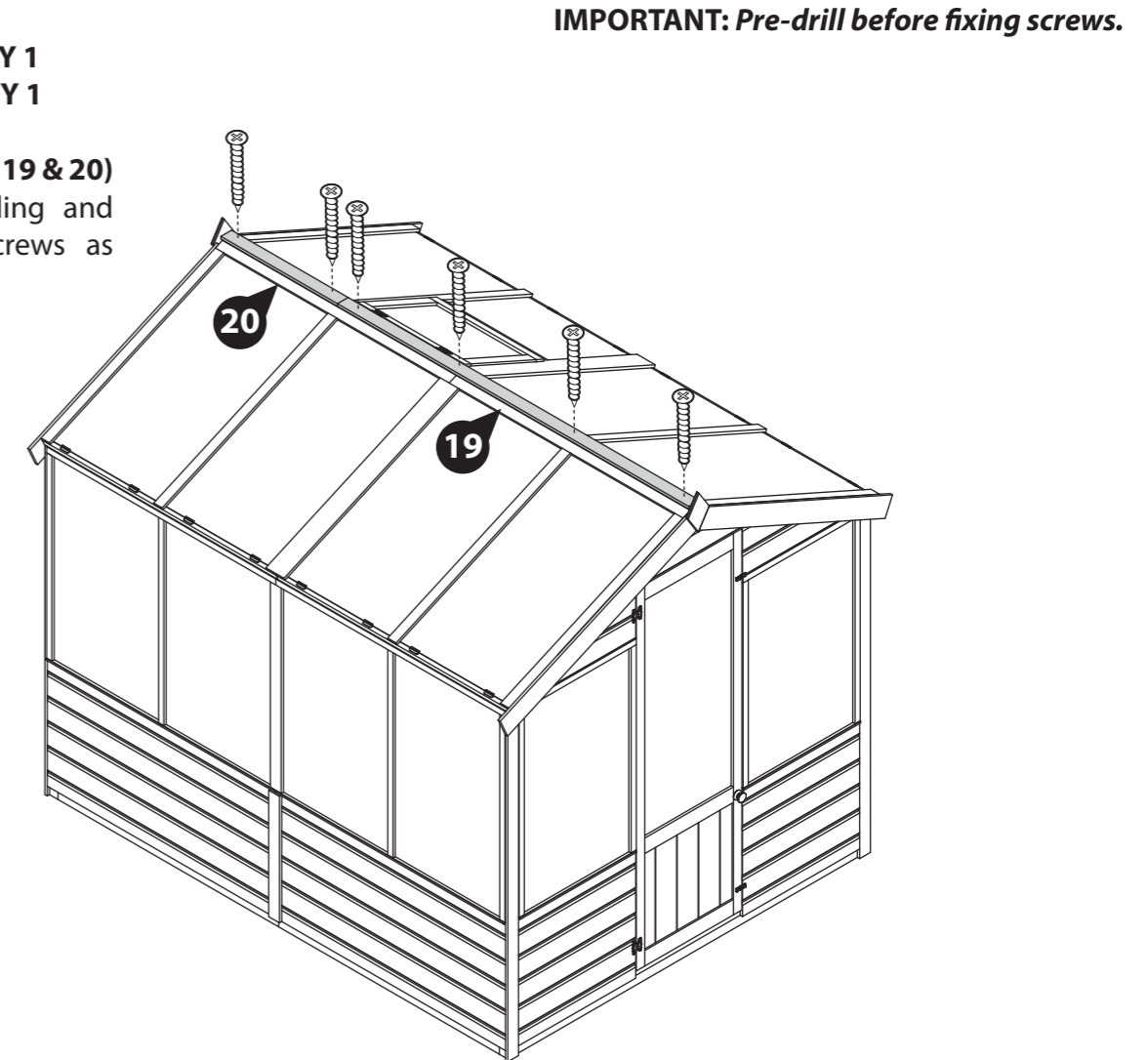

### Step 28

Once constructed, apply a preserving treatment and a waterproofing treatment to your garden building as soon as possible. This will help to protect your building and prevent decay.

See page 28 for a full guide and instructions.

Once fully treated, score around the protective covers on the glazing and carefully peel the covers back.

It is essential to seal around all window framing with silicone sealant (not included) to minimise water ingress.



Apply treatment   Score and peel   Seal with Silicone

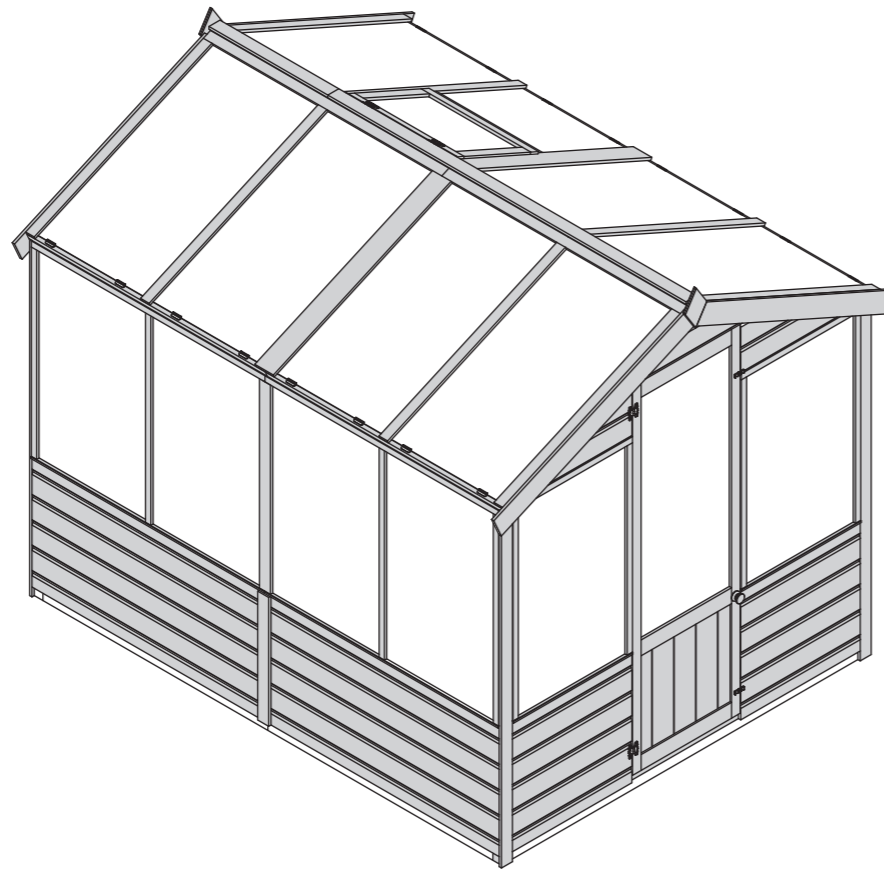
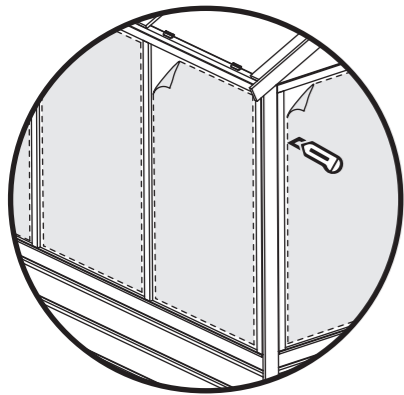

### Greenhouse and apex shed assembly

(04DTSTRDAX0806HGS-V1 + 01DTSHAX0406SDFW-V2)

**Overall Dimensions:**   **Base Dimensions:**  
 Width = 2042mm   Width: 1864mm  
 Depth = 3677mm   Depth: 3602mm  
 Height = 2060mm

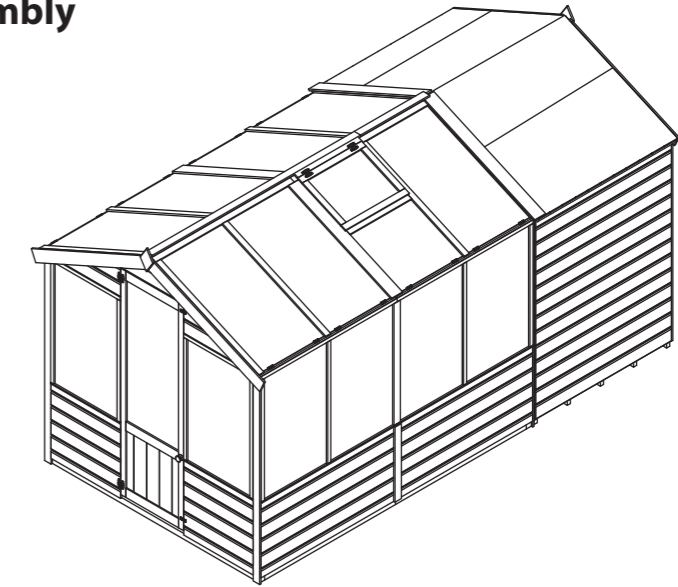

**\*\*Please note:**

This product can be installed with the shed door either inside the building (*internal*) or outside (*external*). Before beginning assembling, decide which configuration best suits your needs and read through both sets of instructions carefully.

**Pre-assembly.**

Follow the instructions for the 4x6 apex shed **01DTSHAX0406SDFW-V2** to fully construct the building.

**DO NOT** fix the fascias and finial on either the front or back of the building, depending where you want to construct your greenhouse (shed door internally or externally).

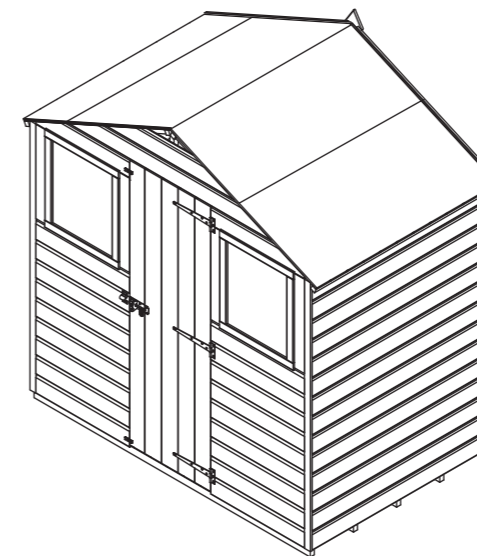

**Greenhouse to be built on the front (internal shed door).**

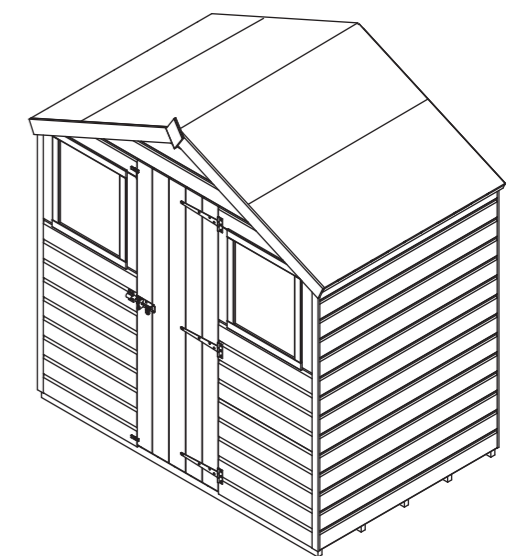

**Greenhouse to be built on the back (external shed door).**

**Please note:** Not all components from the greenhouse contents will be used to construct the greenhouse along side the shed and therefore will be left over once the build is complete. Please dispose of these responsibly.

## LEAVE US A REVIEW...



Want to share your experience with us?  
 Leave us a review on Feefo, TrustPilot or Google.

Your reviews help other people find and trust our business, as well as helping to play an important role in our growth and improvement!



**Step 1a**

**Parts needed - No. 11 QTY 2**  
**No. 12 QTY 4**

**IMPORTANT: Pre-drill before fixing screws.**

Lay the Base Frames (**No. 11 & 12**) down on a flat and level base. Ensure the framing is flush and level and that Base Frame B, sits on the inside of Base frame A, as shown.

Fix the base framing (**No. 11 & 12**) together using 2x70mm screws per corner and 2x70mm screws per join.

**8x70mm screws.**

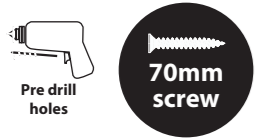

**Internal Door:**

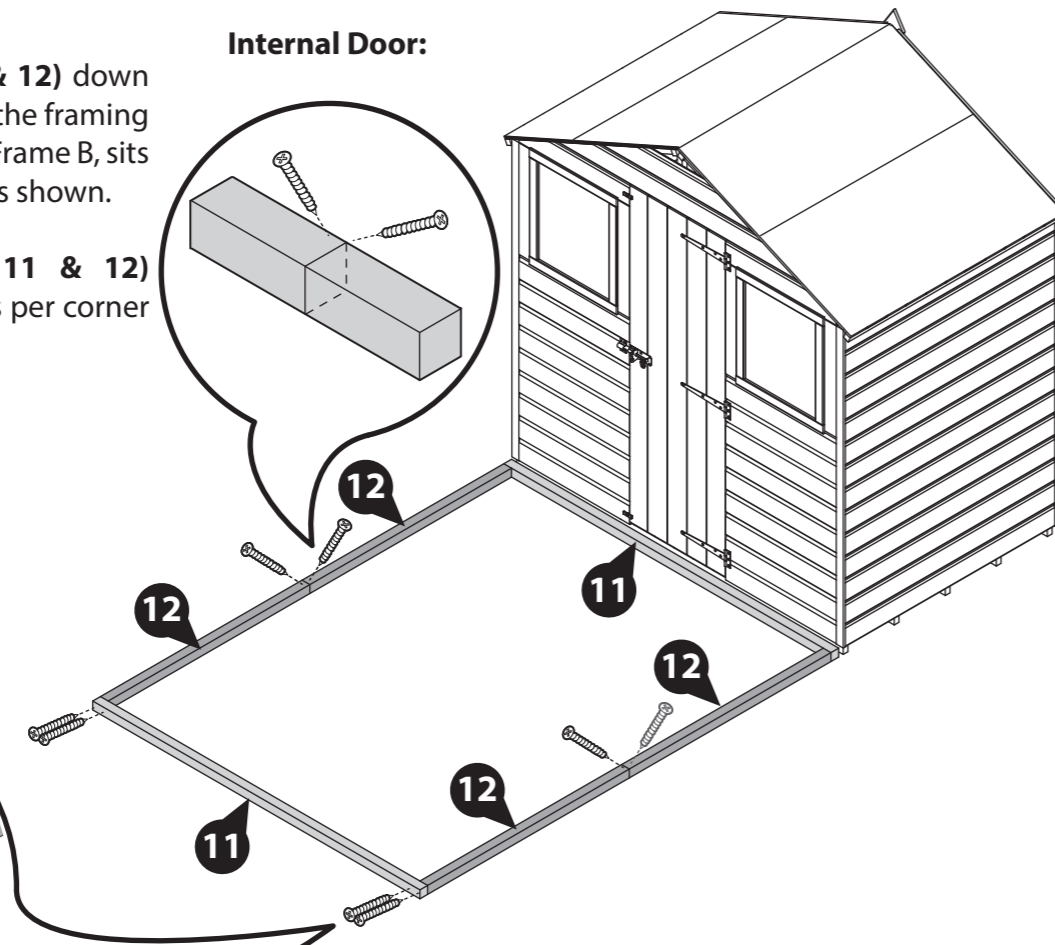
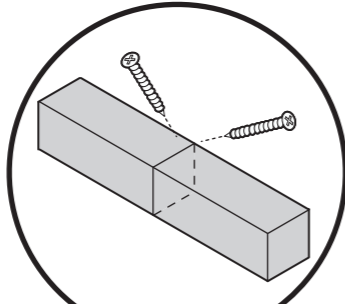

**External Door:**

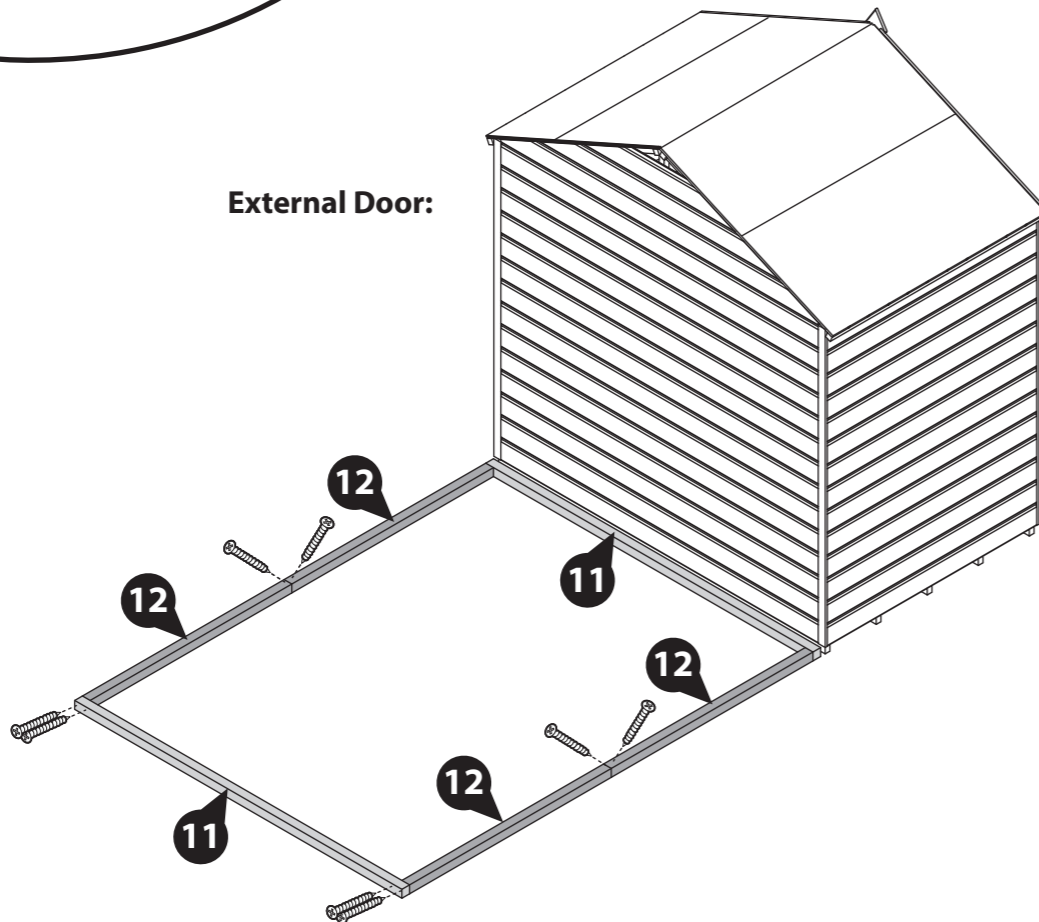

**IMPORTANT: Pre-drill before fixing screws.**

**Step 2a**

**Parts needed - No. 1 QTY 2 No. 37 QTY 2**  
**No. 2 QTY 4 No. 38 QTY 4**  
**No. 33 QTY 13**

- a** Lay the Door Sides (**No. 1**), Small Window Sides (**No. 2**) and Large Window Side (**No. 3**) down on a flat and level base.
- b** Place the Plastic Cills 610mm (**No. 37**) onto the lip of the external window opening of the Door sides (**No. 1**). Secure the Cill to the framing using 3x30mm screws.
- c** Place the Plastic Cills 1193mm (**No. 38**) onto the lip of the external window opening of the Small Window Sides (**No. 2**). Secure the Cill to the framing using 3x30mm screws.
- d** Place the styrene (**No. 33**) on top of the cills, ensuring there is equal spacing on all sides, as shown.

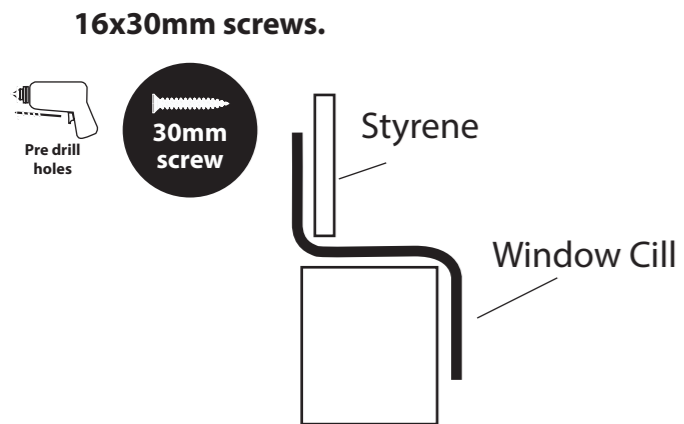
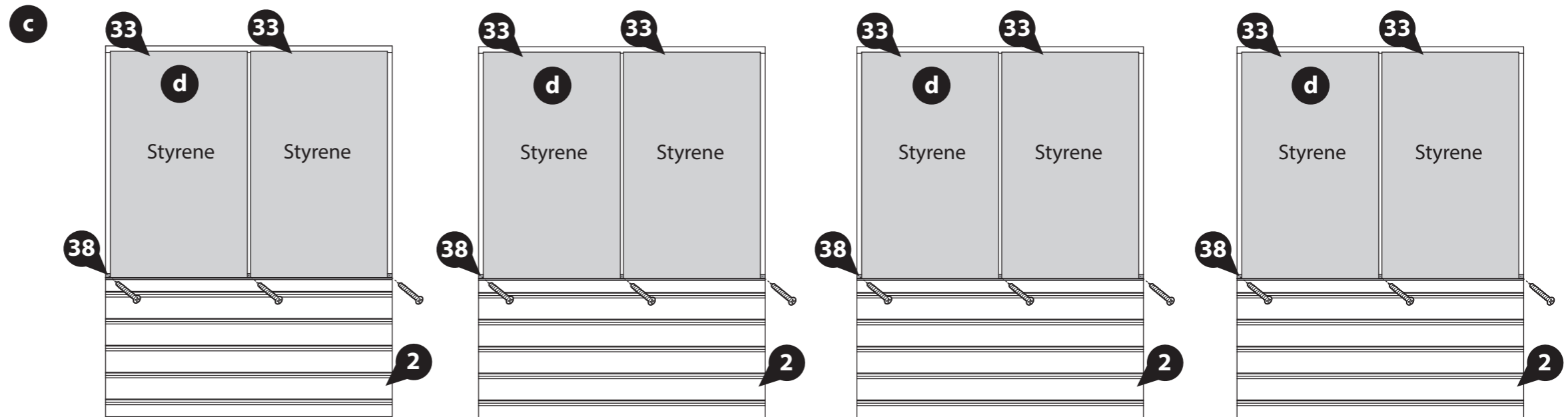
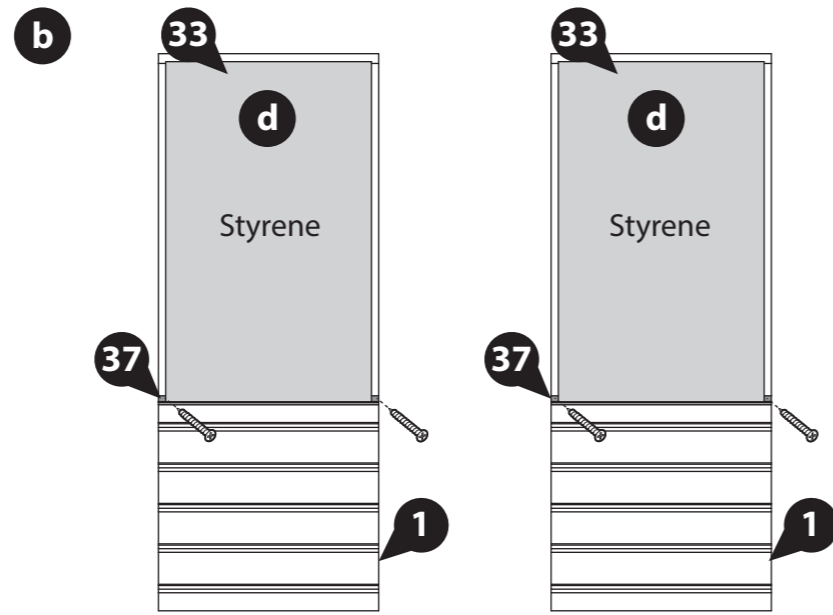

**IMPORTANT: Pre-drill before fixing screws.**

**Step 3**

**Parts needed - No. 27 QTY 12**

**No. 29 QTY 4**

**No. 30 QTY 2**

**a** On the Door sides (**No. 1**) locate Window strips (**No. 27**) onto either side of the panel and the Window Strips (**No. 30**) along the top of the panel, ensuring to trap the styrene. Fix in place using 3x30mm screw per strip.

**b** On the Small Window Side (**No. 2**) locate Window strips (**No. 27**) onto one side of the panel, where the styrene joins and the Window Strip (**No. 29**) along the top of the panel, ensuring to trap the styrene.

*Note: Working in pairs of panels, ensure to leave one side without a strip, as shown. This will be covered once the panels have been fixed together.*

Fix in place using 3x30mm screw per side strip and 4x30mm screws for the top strip.

**Note: Ensure the framing does not protrude the width of the window frame.**

**58x30mm screws.**

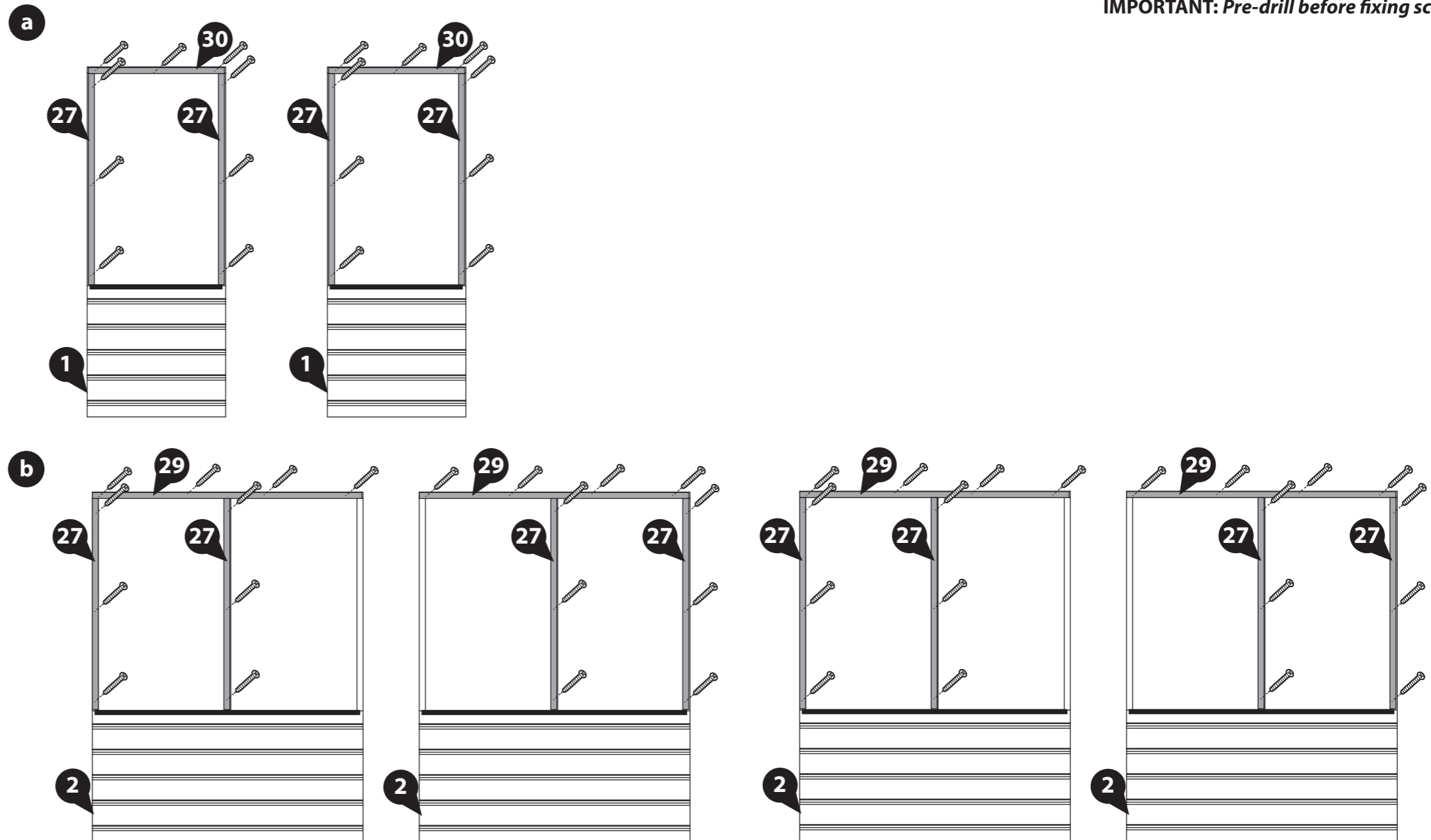

**Step 4a**  
Parts needed - No. 2 QTY 2

Locate two Small Window Sides (No. 2) on top of the base frame and flush to the shed, ensure there is equal spacing between the panels and the base frame on each side.

Secure the panels to the shed by screwing through the corners using 3x50mm screws.

**DO NOT fix the panels to the base frame until the roof has been fitted.**

6x50mm screws.

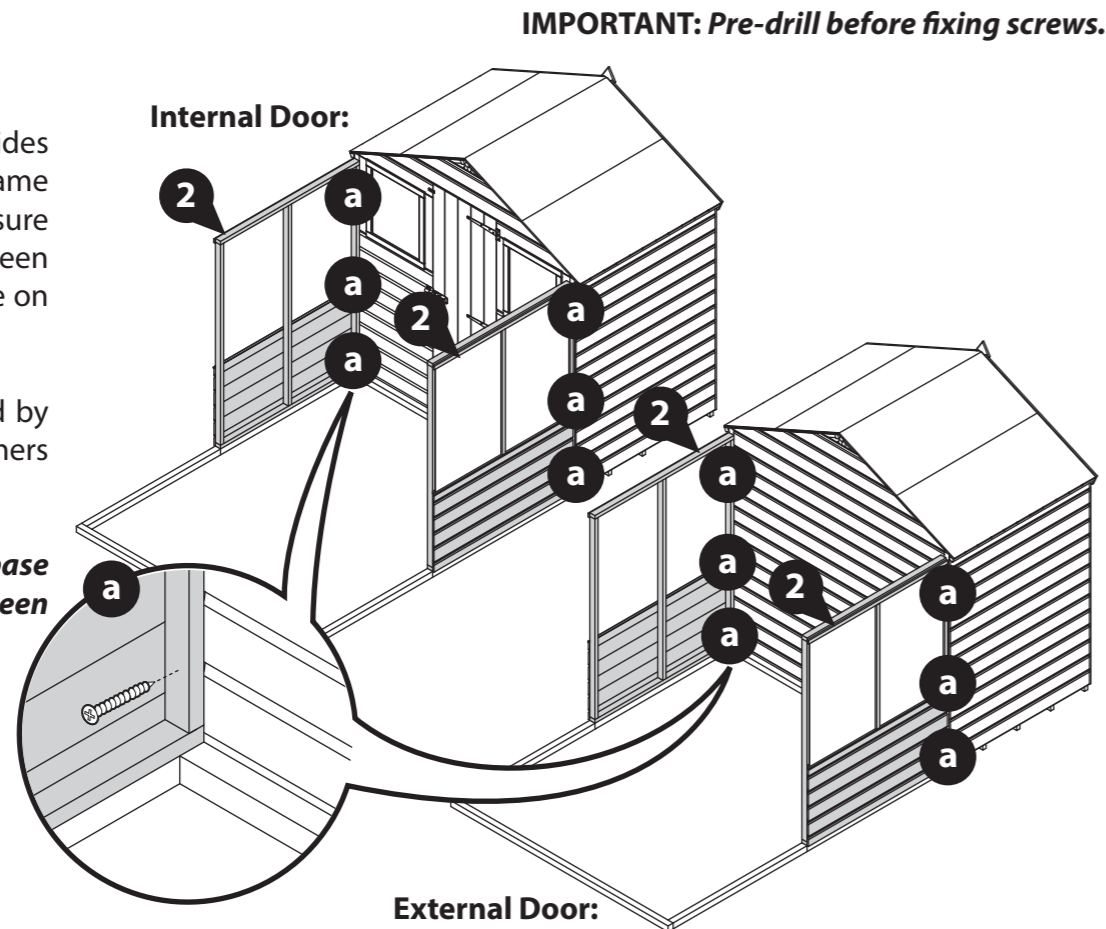
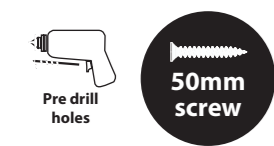

**Step 5a**  
Parts needed - No. 2 QTY 2

Locate two Small Window Sides (No. 2) on top of the base frame and flush to the previously placed Small Window Sides, ensure there is equal spacing between the panels and the base frame on each side.

Secure the panels to the adjacent panel using 3x50mm screws per side.

**DO NOT fix the panels to the base frame until the roof has been fitted.**

6x50mm screws.

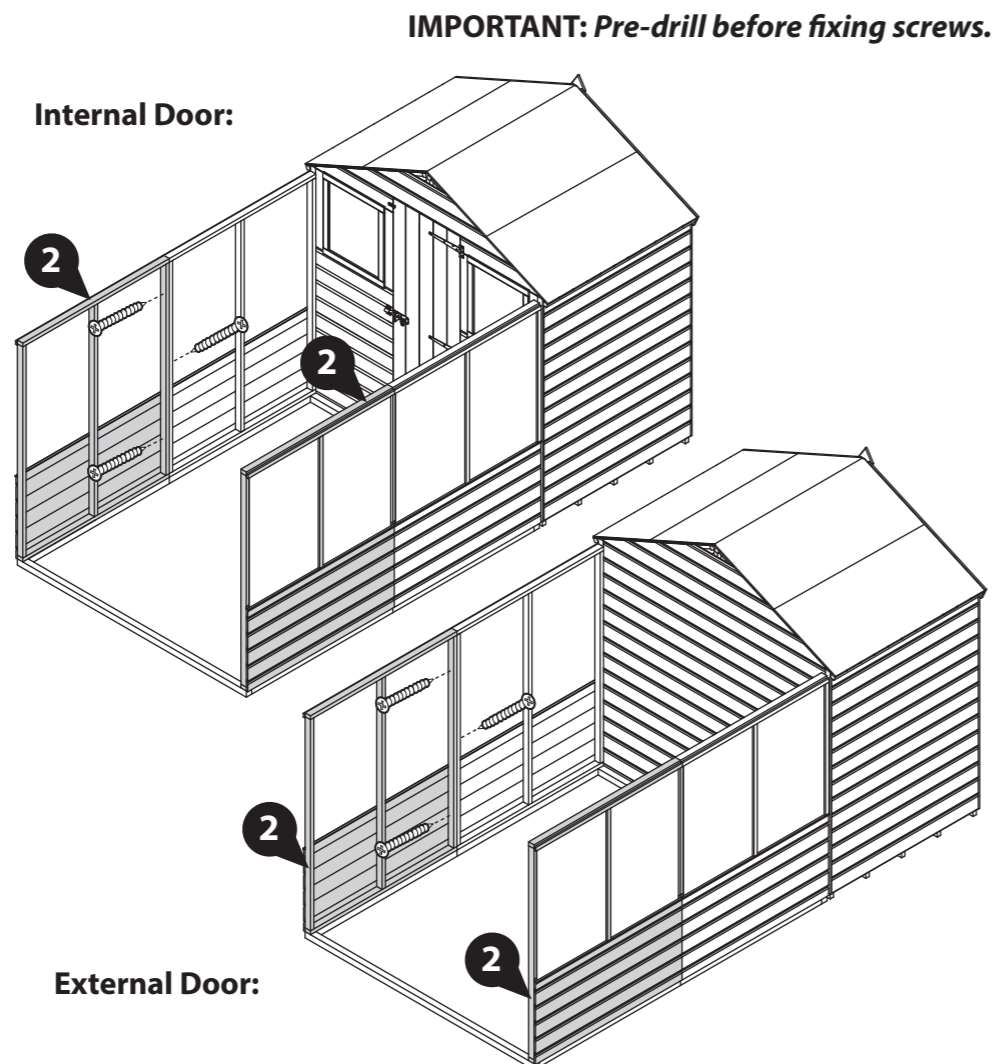

**Step 6a**  
Parts needed - No. 1 QTY 2

Locate two Door Sides (No. 1) on top of the base frame and flush to the Small Window sides.

**Please note: the Door sides will sit inside the Window Sides.**

Secure the panels to the Window Sides by screwing through the framing at the corners using 3x50mm screws per side.

**DO NOT fix the panels to the base frame until the roof has been fitted.**

6x50mm screws.

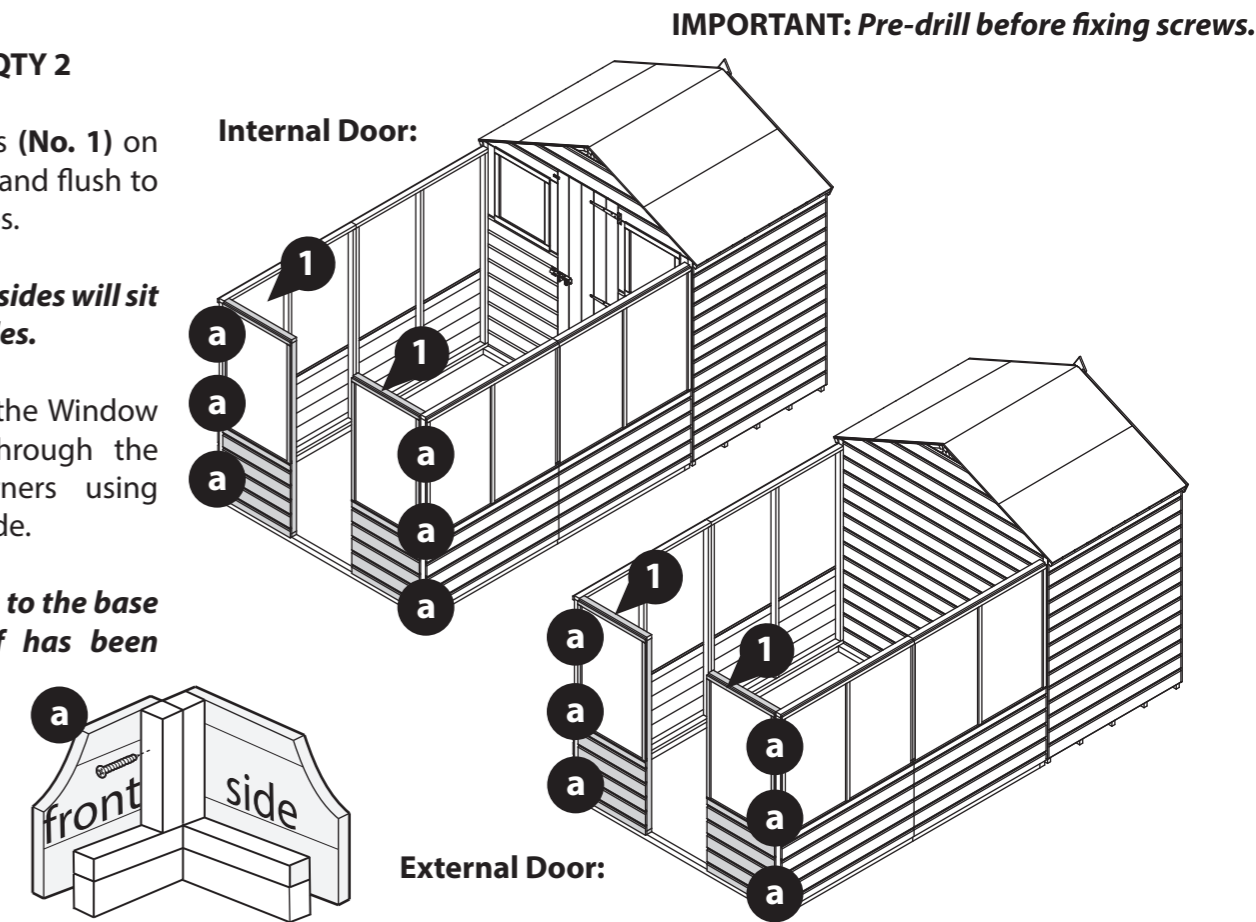

**Step 7a**  
Parts needed - No. 16 QTY 1

Locate the Door Frame (No. 16) onto the base framing between the Door Sides (No. 1).

Fix in place using 3x40mm screws.

*This allows the Door Sides to be correctly spaced.*

3x40mm screws.

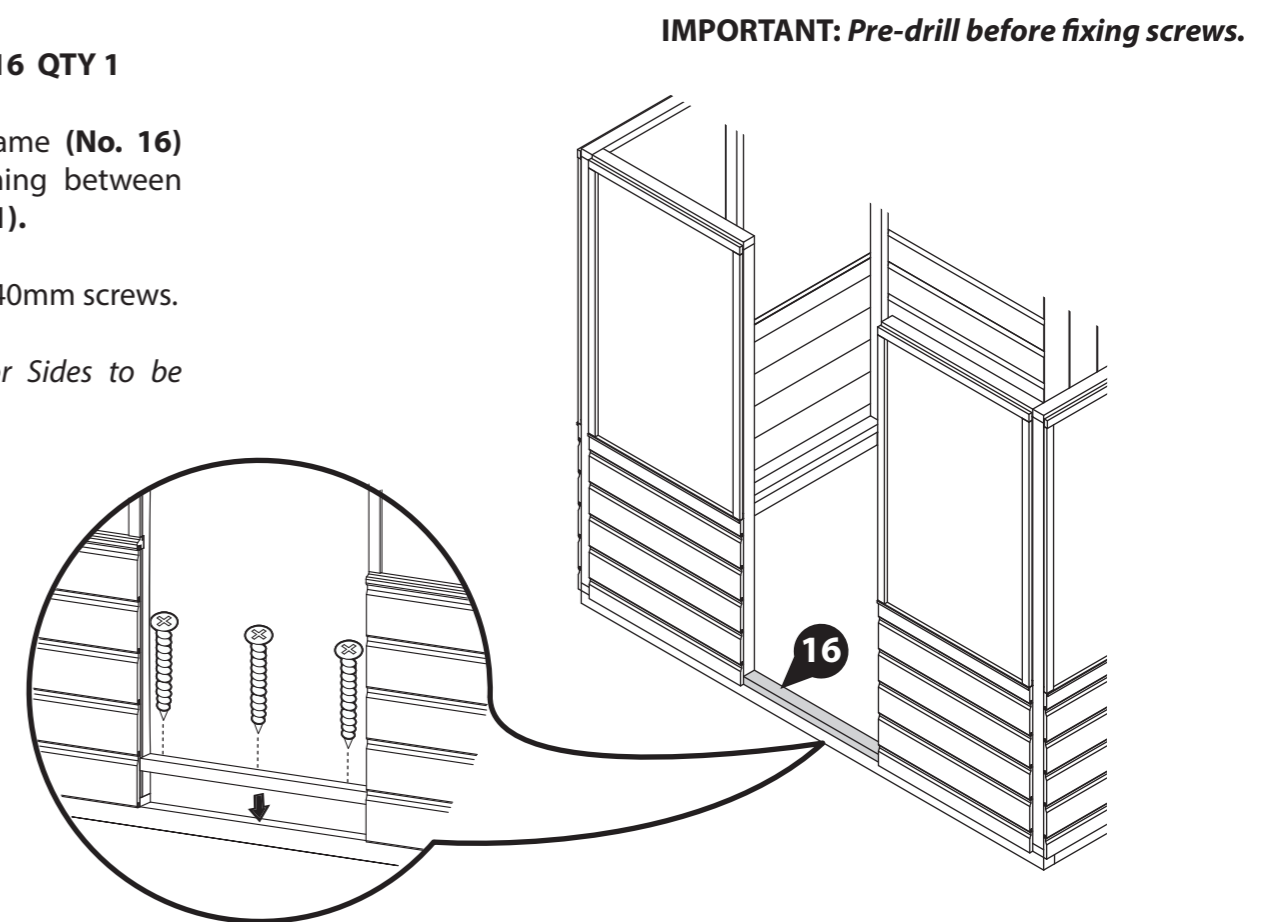

**Step 8a**

**Parts needed - No. 43 QTY 2**

Locate a Strip (No. 43) over the joining of the Small Window Panels (No. 2) on either side.

Fix in place using 4x30mm screws per strip.

**8x40mm screws.**

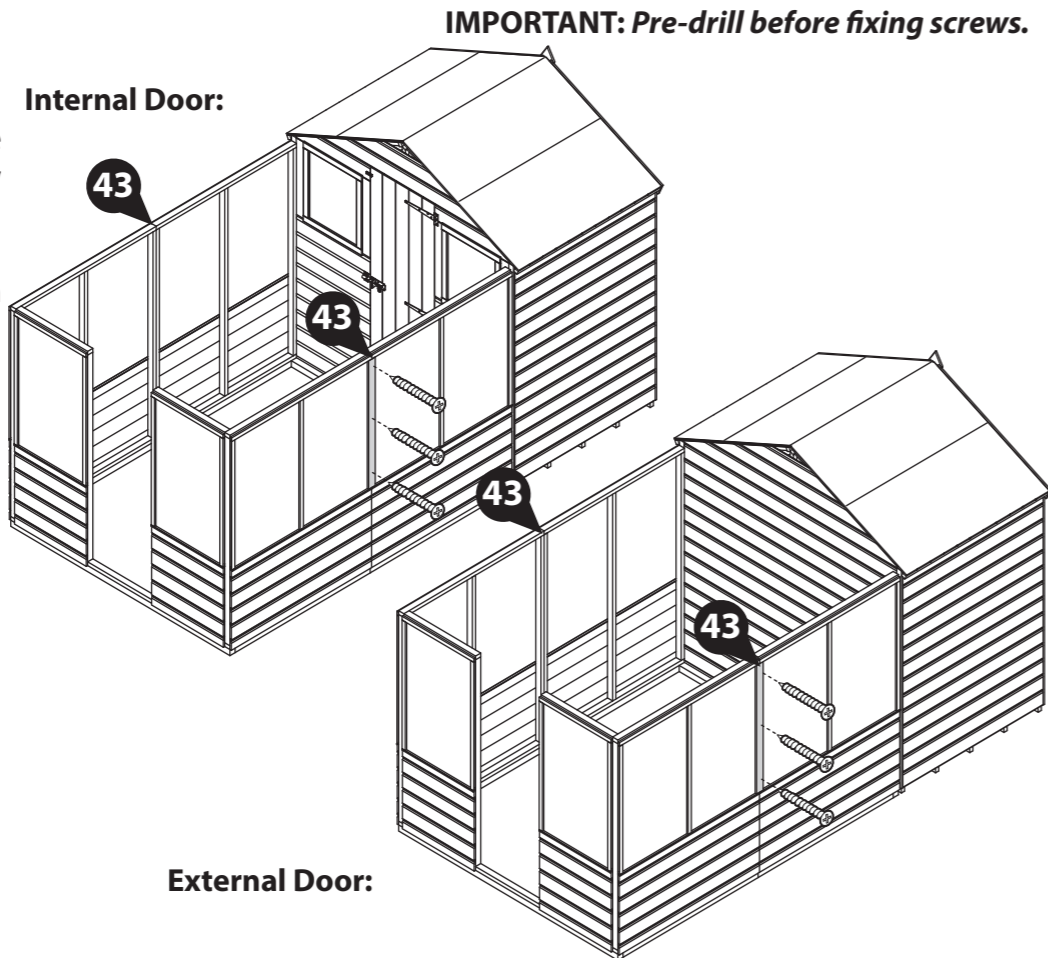
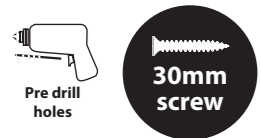

**Step 10a**

**Parts needed - No. 17 QTY 2**

Locate the two Door strips (No. 17) to either side of the door opening, ensuring the Strips are flush with the internal framing of the panel, as shown.

Fix in place using 3x30mm screws per strip.

**6x30mm Screws.**

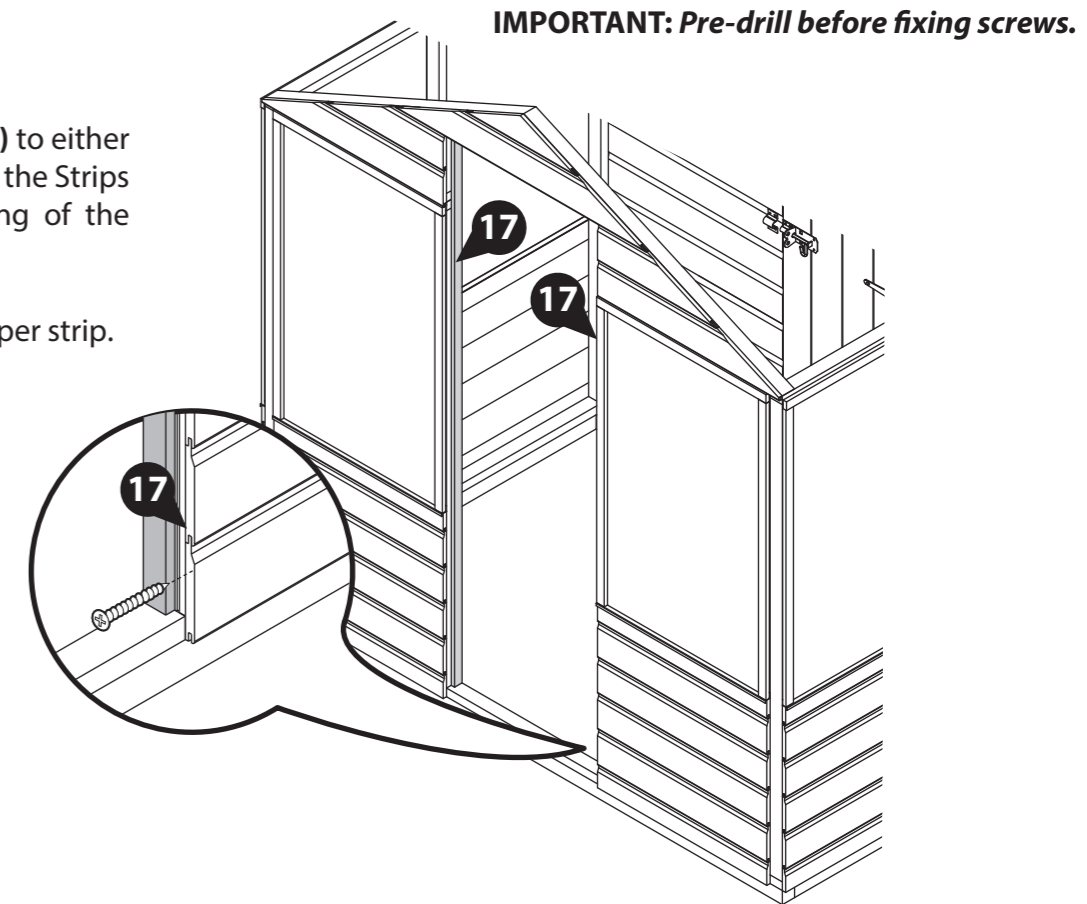

**Step 9a**

**Parts needed - No. 4 QTY 1**

Locate the Door Gable top (No. 4) on top of the Door Sides, as shown.

Secure the gable in place using 4x50mm screws, screwing through the panel framing into the gable framing above.

**4x50mm screws.**

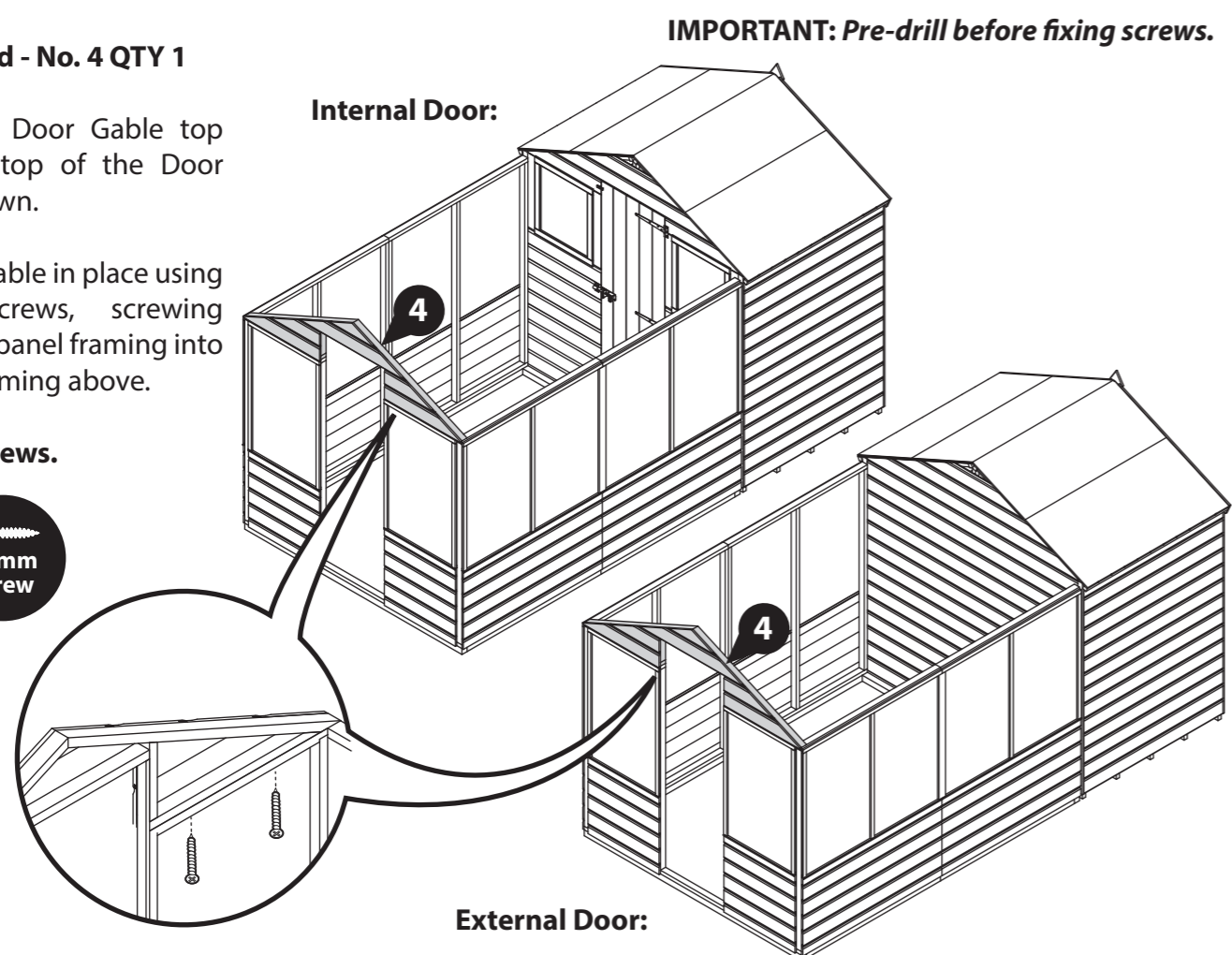
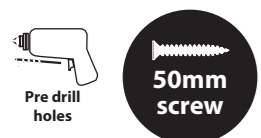

**Step 11a**

**Parts needed - No. 18 QTY 1**

Locate the Short Door strip (No. 18) to the top of the door opening.

Fix in place using 3x30mm screws.

**3x30mm Screws.**

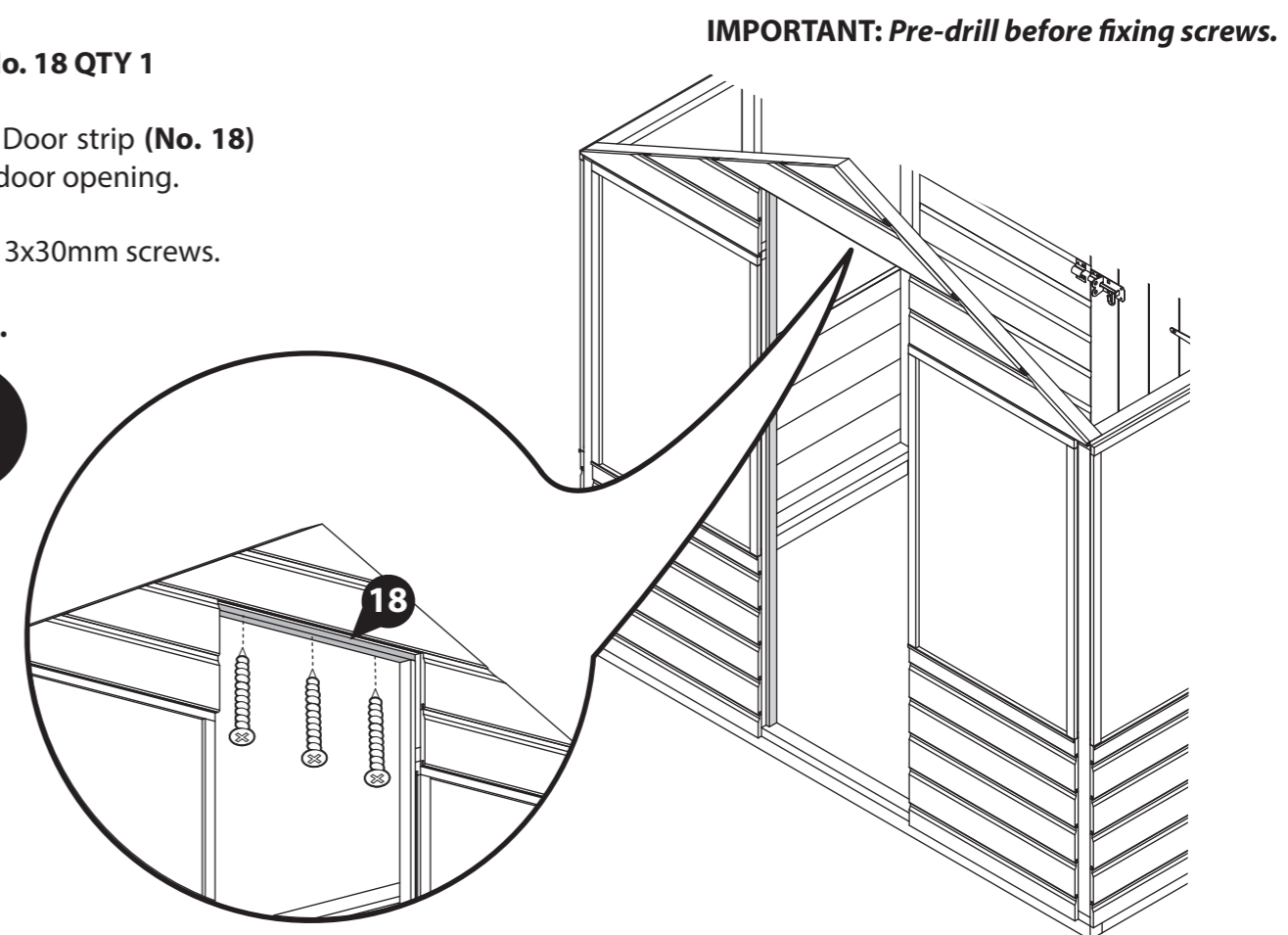

**Step 12a**  
**Parts needed - No. 15 QTY 4**

Align the Fascia Blocks (No. 15) to the top edge of the Door Gable Top and fix in place using 2x50mm screws per block.

**8x50mm Screws.**



**IMPORTANT: Pre-drill before fixing screws.**

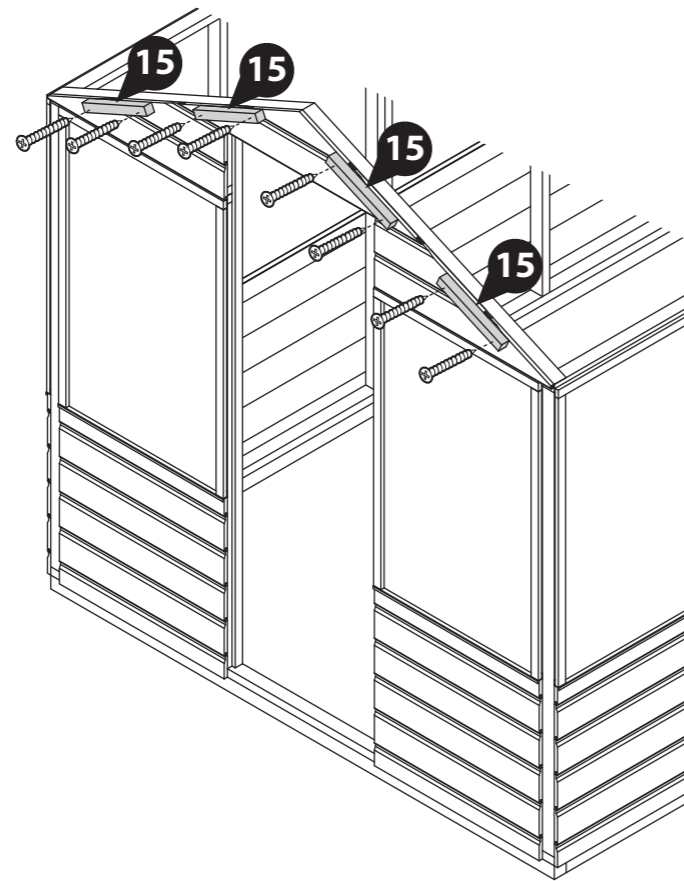

**Step 13a**  
**Parts needed - No. 6 QTY 1**  
**No. 23 QTY 4**  
**No. 34 QTY 1**  
**No. 35 QTY 1**

Lay the roof panel (No. 6) down ensuring the thinner edge of the frame is at the bottom.

Apply a neat line of silicone sealant (not provided) along the panel framing. Place the styrene sheets (No. 34 & 35) in position as shown.

Fix in place using two Window Glazing beads (No. 23) per Styrene sheet. Evenly space the Window Glazing Beads before fixing. Screw down through the bead into the framing below using 2x16mm screws per bead.

**8x16mm Screws.**



**IMPORTANT: Pre-drill before fixing screws.**

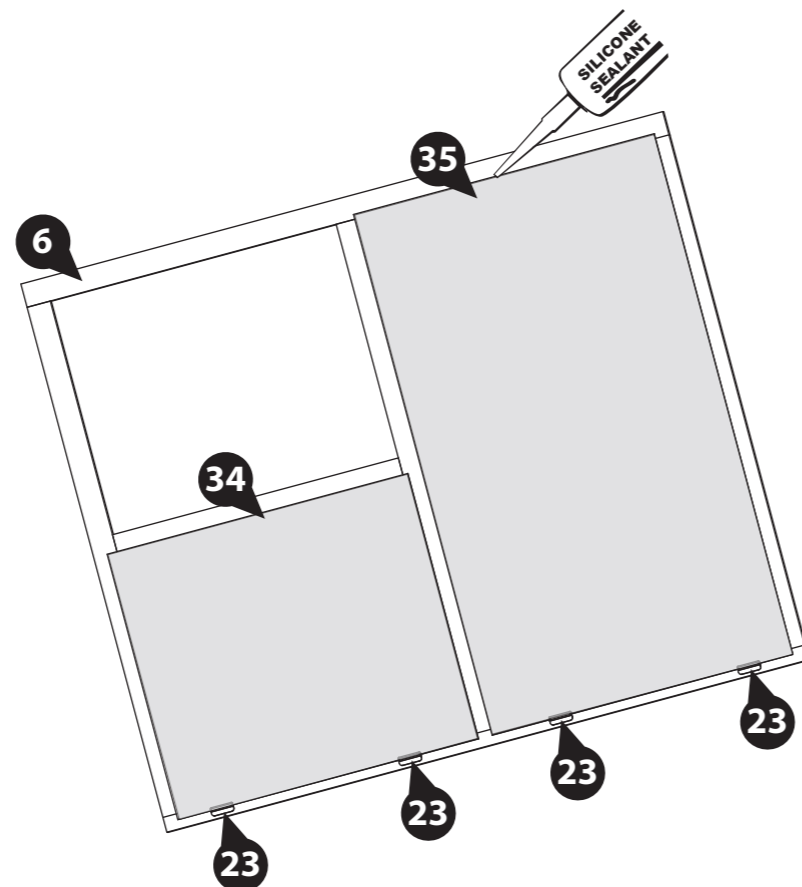

**Step 14a**  
**Parts needed - No. 31 QTY 1**  
**No. 32 QTY 2**  
**No. 36 QTY 1**

Locate the strips (No 31, 32, & 36) onto the top of the Roof panel, ensure to trap the styrene and that the framing is flush to the edge of the panel and each strip, as shown.

Ensure to leave one side of the panel free from any strips, as this will be covered once attached to the other Roof panel.

Fix the strips in place using 3x30mm screws per strip. Ensure you screw to the side of the styrene not through it.

**12x30mm Screws.**



**IMPORTANT: Pre-drill before fixing screws.**

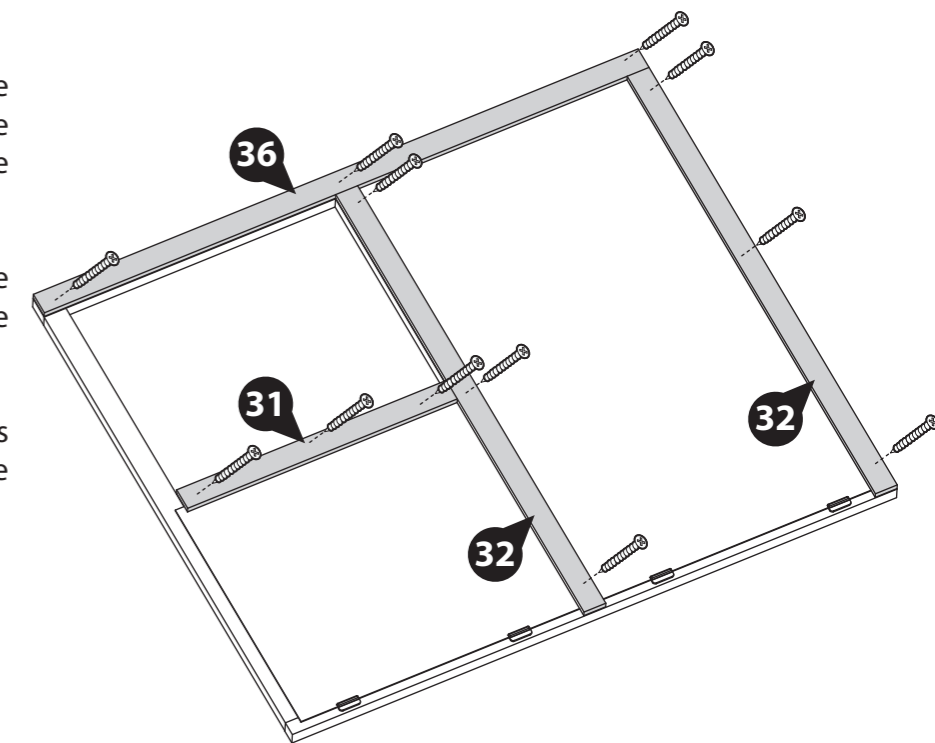

**Step 15a**

**Parts needed - No. 9 QTY 1**  
**No. 21 QTY 2**  
**No. 40 QTY 1**

Locate the Opening Window (**No. 9**) into the Window aperture, ensuring equal spacing on all sides.

Locate the strip (**No. 40**) onto the window panel above the Window (**No. 9**) and fix in place with 4x30mm screws.

Locate the Hinges (**No. 21**) onto the Strip (**No. 40**) and Window (**No. 9**), as shown.

Secure in place using 4x16mm and 4x30mm black screws per hinge, as shown. Use the 16mm screws to secure the hinge to the opening window and 30mm securing into the strip.

**4x30mm Screws.**  
**8x30mm Black Screws.**  
**8x16mm Black Screws.**

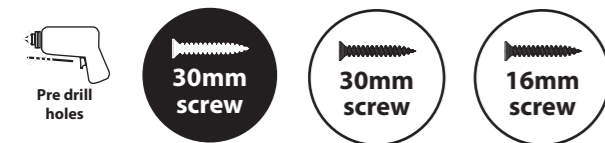

**IMPORTANT: Pre-drill before fixing screws.**

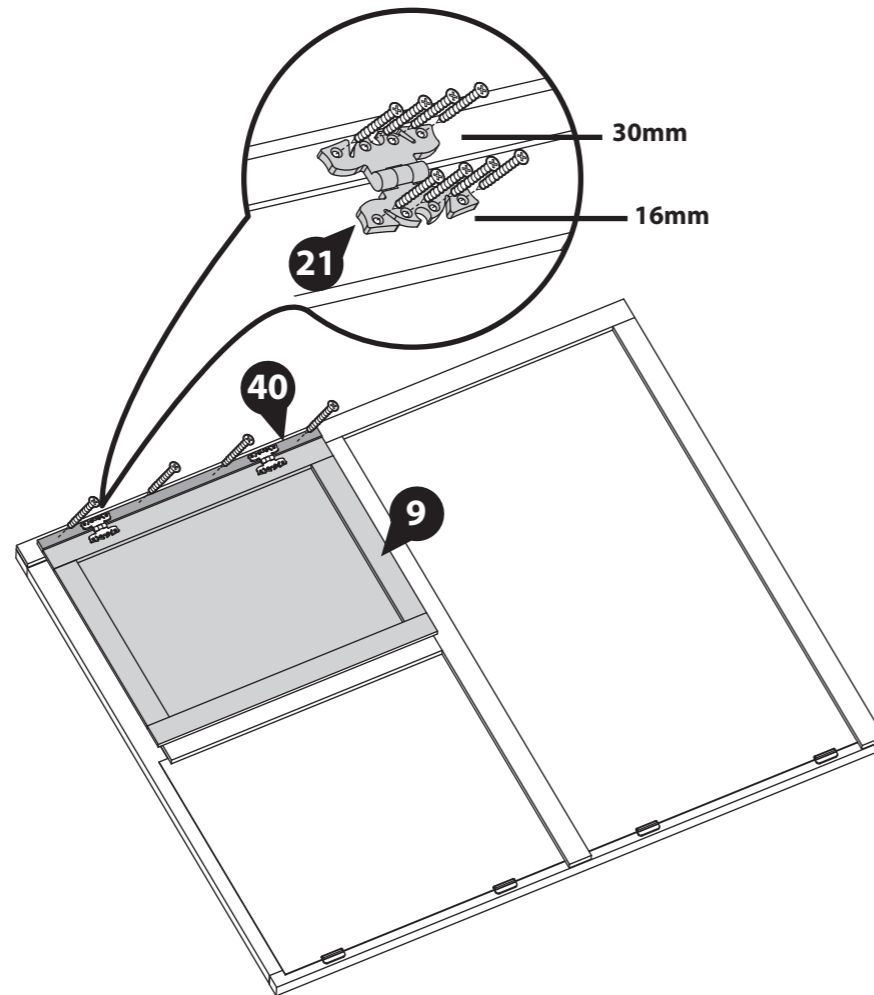

**Step 16a**

**Parts needed - No. 7 QTY 3**  
**No. 23 QTY 12**  
**No. 35 QTY 6**

Lay the Roof Panels (**No. 7**) down ensuring the thinner edge of the frame is at the bottom.

Apply a neat line of silicone sealant (not provided) along the panel framing. Place the styrene sheets (**No. 35**) in position as shown.

Fix in place using two Window Glazing beads (**No. 23**) per Styrene sheet. Evenly space the Window Glazing Beads before fixing. Screw down through the bead into the framing below using 2x16mm screws per bead.

**Repeat for all three Roof Panels.**

**24x16mm Screws.**



**IMPORTANT: Pre-drill before fixing screws.**

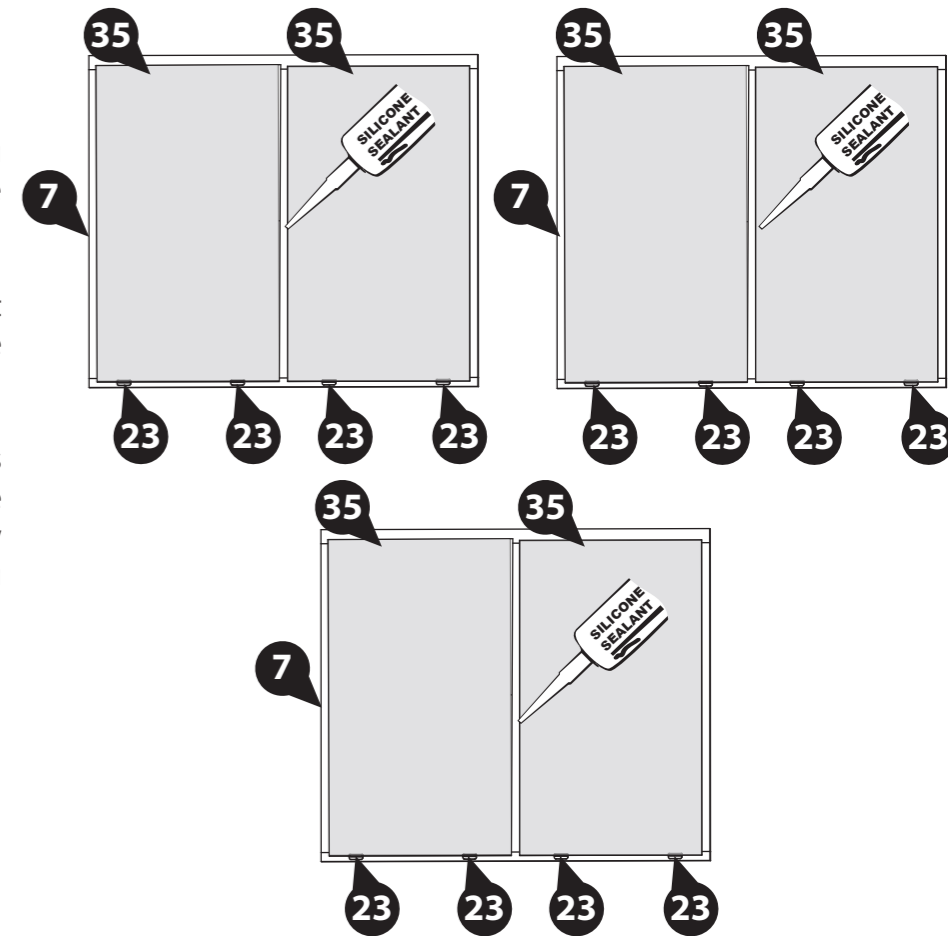

**Step 17a**

**Parts needed - No. 32 QTY 6**  
**No. 36 QTY 3**

Locate the strips (**No. 32 & 36**) onto the top of the Roof panel, ensure to trap the styrene and that the framing is flush to the edge of the panel and each strip, as shown.

Do not fit strips on the inside of the roof panels which will sit next to another roof panel, see illustration.

Fix the strips in place using 3x30mm screws per strip. Ensure you screw to the side of the styrene not through it.

**Repeat for all the Roof Panels.**

**27x30mm Screws.**



**IMPORTANT: Pre-drill before fixing screws.**

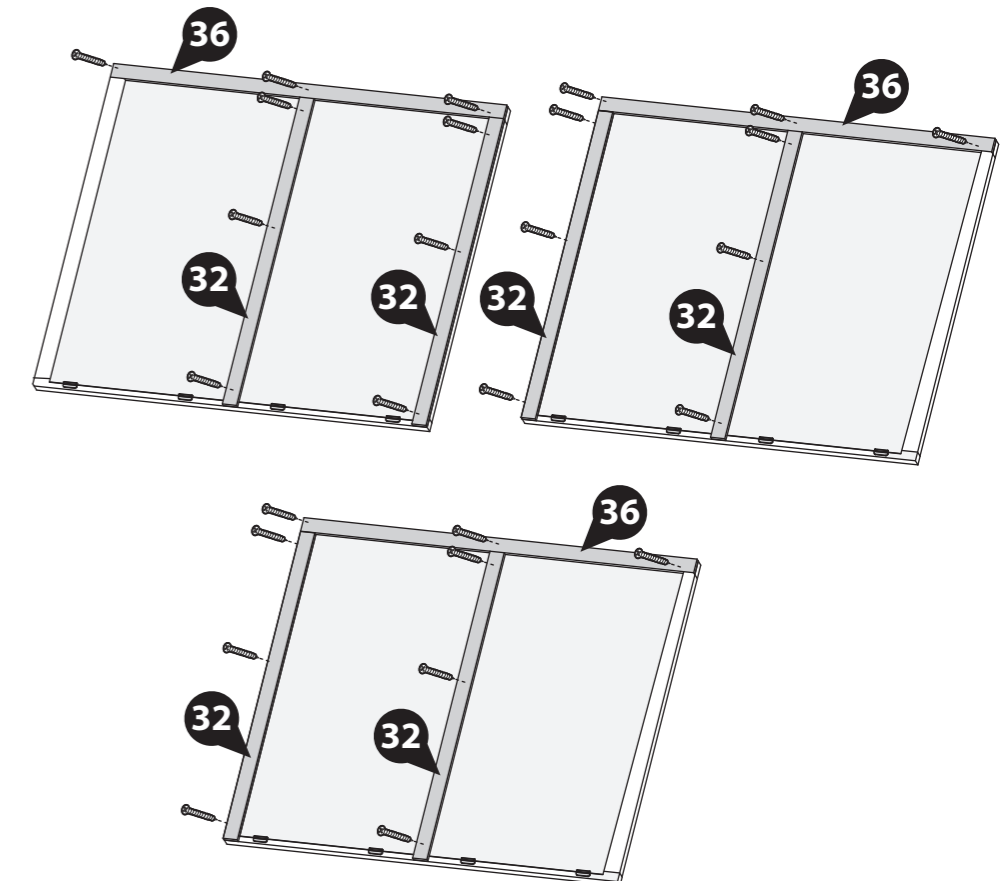

**Step 18a**  
**Parts needed - FROM SHED CONTENTS**  
**No. 11 QTY 2**

Place the greenhouse roof frames (**No. 11**) against each window panel, ensuring the framing is flush to the shed and window frame.

Secure in place using 3x50mm screws per frame, ensuring to screw into each panel.

**6x50mm Screws**

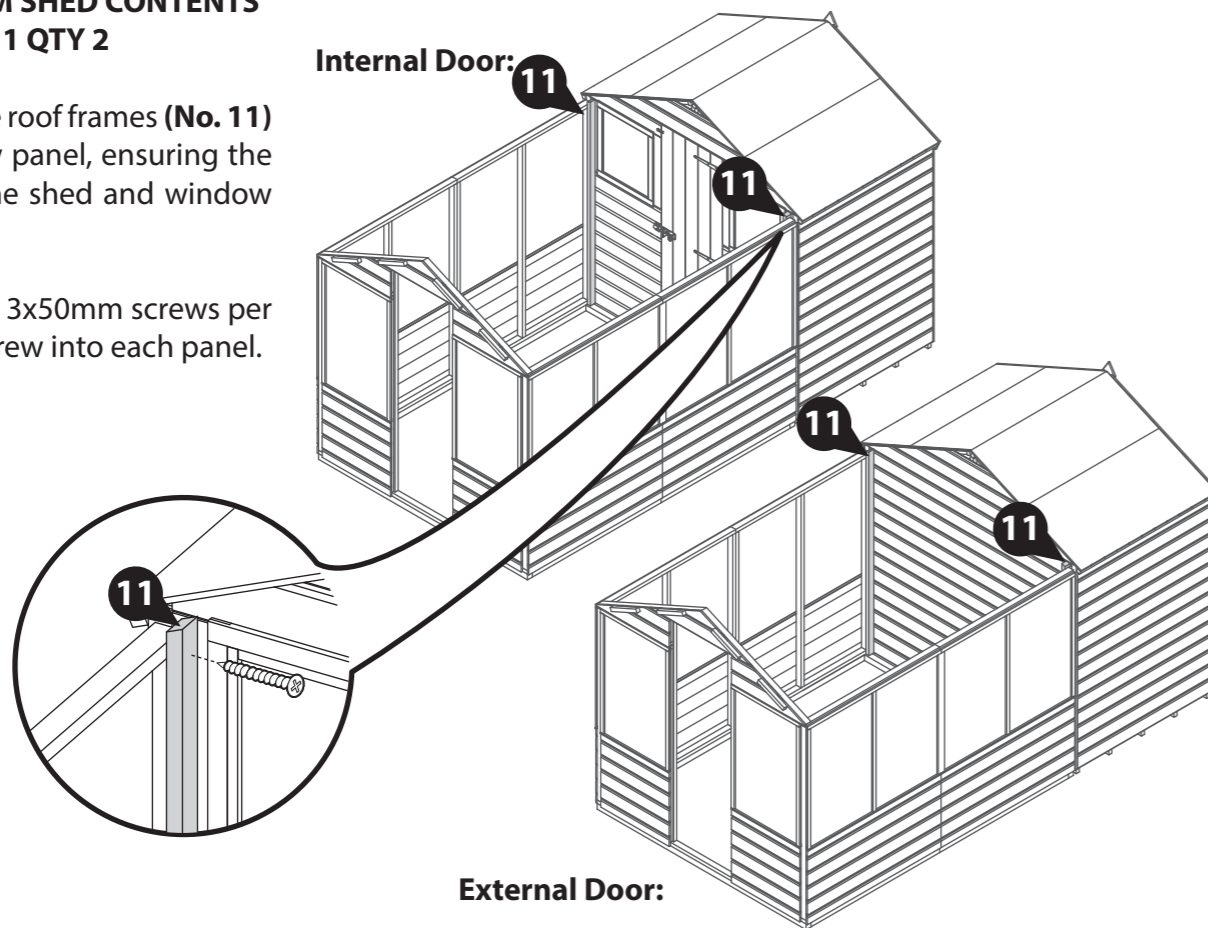
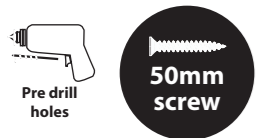

**Step 19a**  
**Parts needed - FROM SHED CONTENTS**  
**No. 12 QTY 1**

Temporarily position the assembled Roofs Panels (**No. 6 & 7**) onto the building, making sure they are flush to the gables and meet at the top of the Apex.

Using the Roof Panels as a guide, mark the position for the roof block at the top of the **shed gable**.

Once marked, remove the Roof Panels and secure the block to the shed gable using 1x70mm screw, making sure to secure through the block into the central upright on the door gable.

**1x70mm Screws**

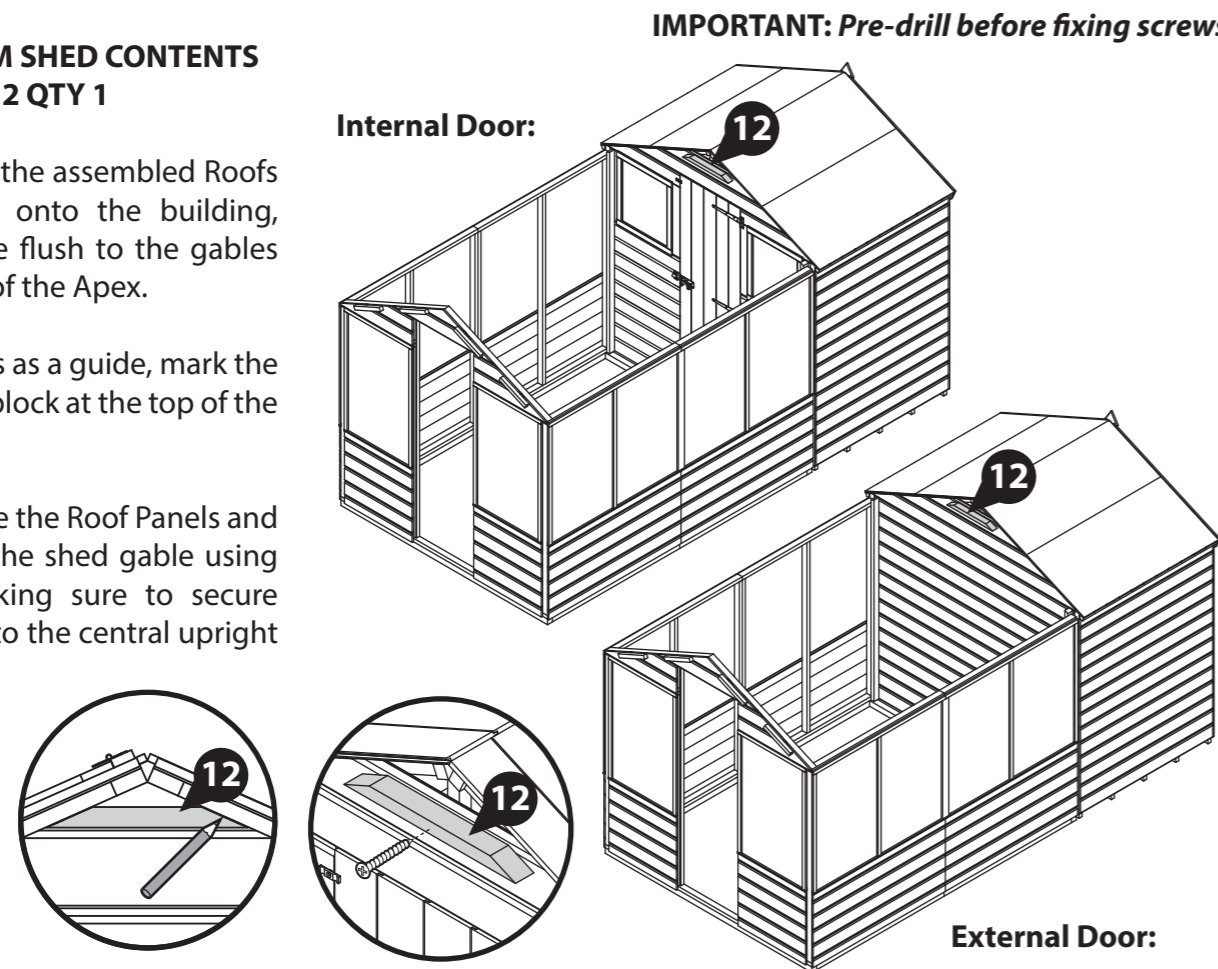

**Step 20a**  
**Parts needed - No. 6 QTY 1**  
**No. 7 QTY 3**

Place the assembled Roof panels (**No. 6 & 7**) on top of the Door Gable, and the Roof Block, making sure the roofs are flush to each gable and meet at the top of the apex.

**\*IMPORTANT: Ensure both roof sections meet at the top of the apex as shown in the illustration.**

Fix the roof panels together from the inside of the greenhouse in the middle using 4x70mm screws per side.

Secure the roof panels to the front gable and Roof Block using 5x50mm screws per roof panel.

Internally, secure the Roof panels to the shed door gable using 3x50mm screws per panel.

**16x50mm Screws.**  
**8x70mm Screws.**

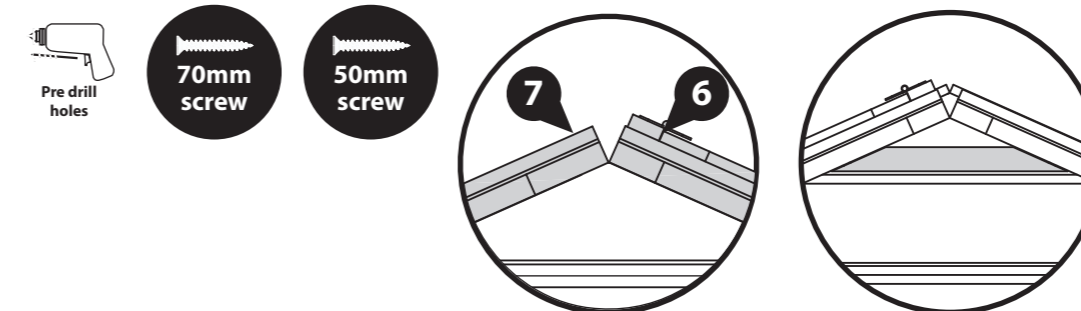

**IMPORTANT: Pre-drill before fixing screws.**

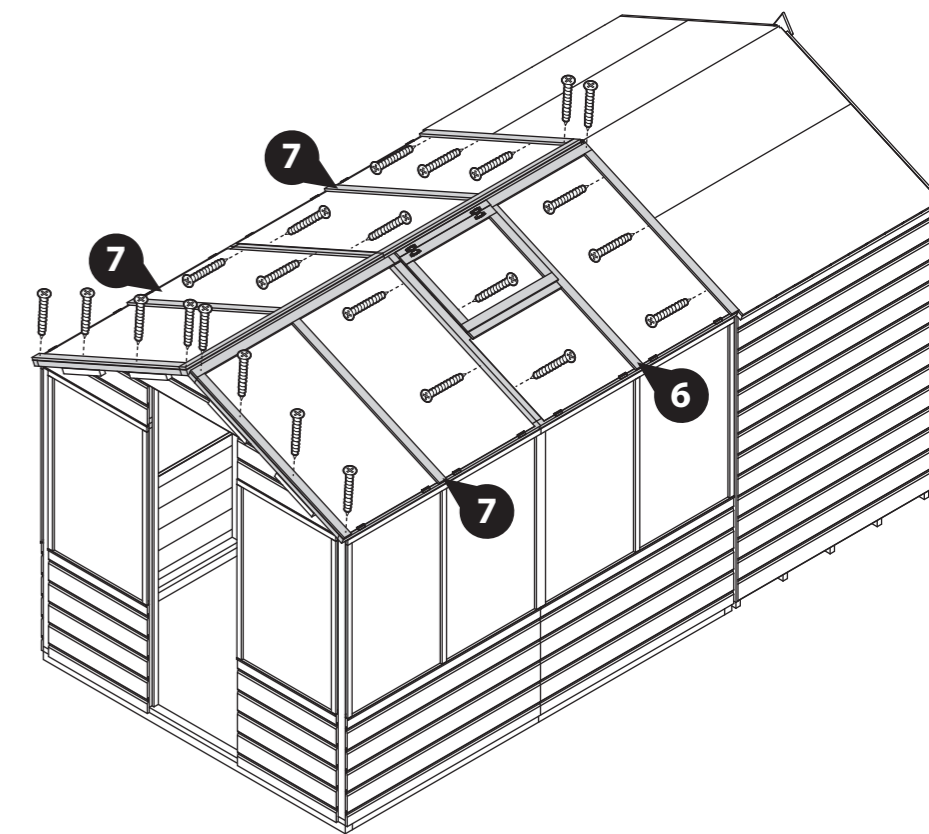



**Step 21a**

Once the roof is secure, the building can be secured to the base framing with 6x50mm screws per side.

**18x50mm Screws.**

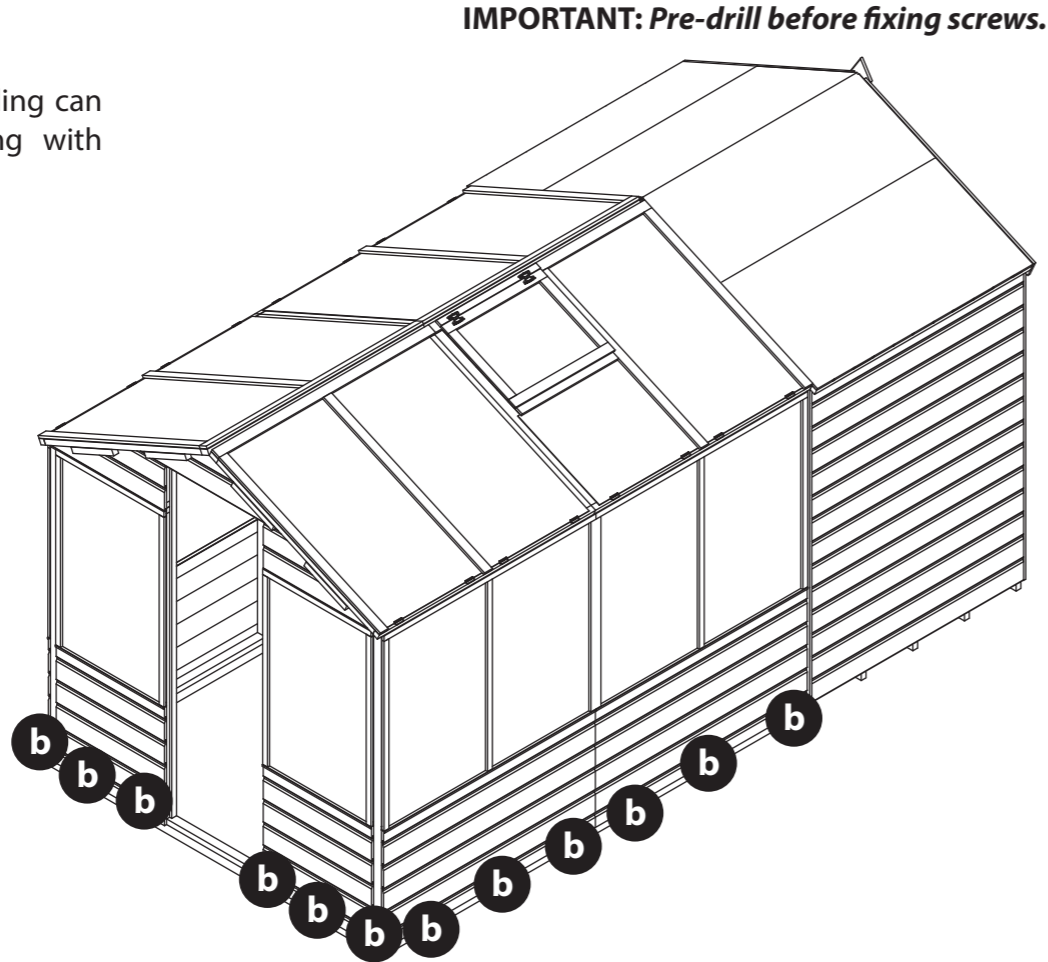
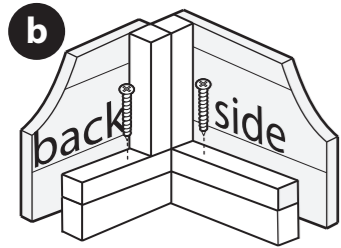

**Step 22a**

**Parts needed - No. 13 QTY 1  
No. 14 QTY 1**

Attach the Roof Support bars (**No. 13 & 14**) to the roof panels using 6x40mm screws.

Screw diagonally through the support into the roof panel as shown in the diagram.

**6x40mm Screws.**

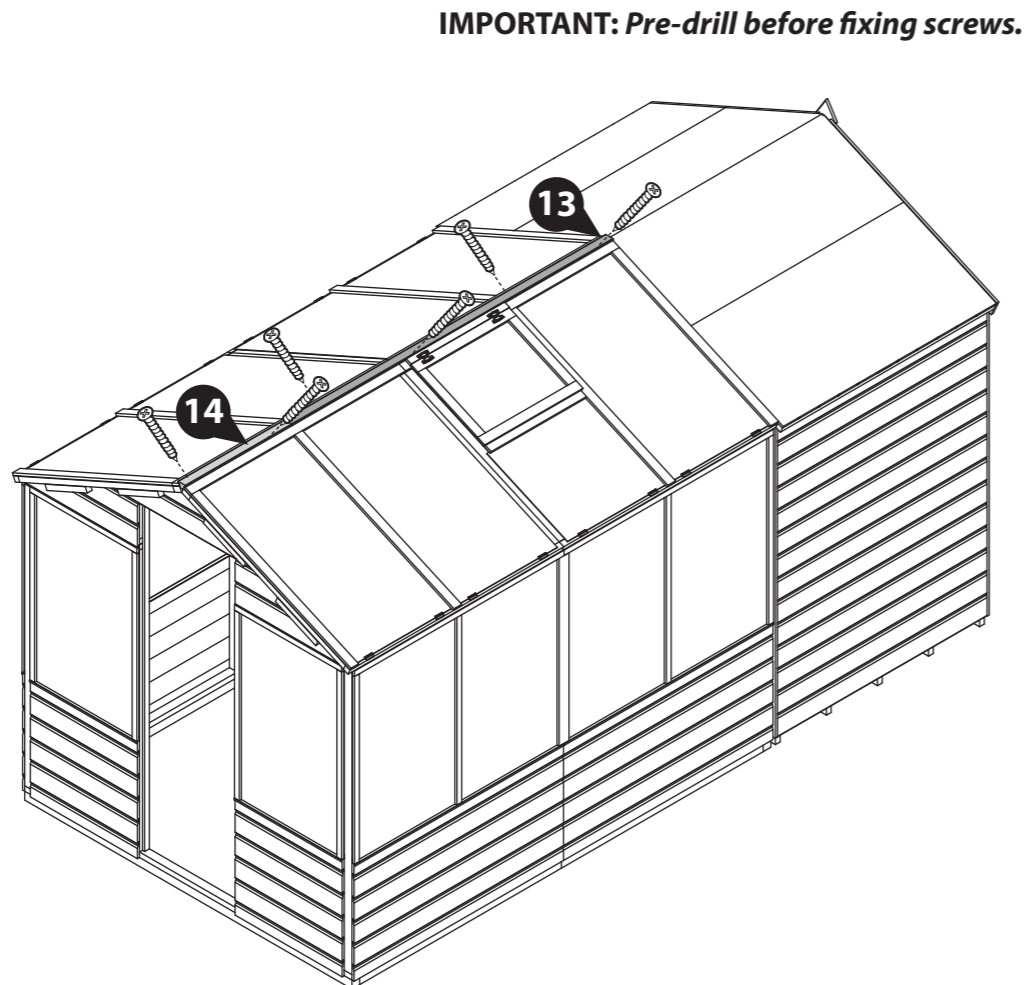
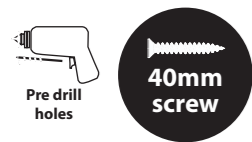

**Step 23a**

**Parts needed - No. 42 QTY 2**

Fix strip (**No. 42**) to the roofs to cover the panel joins using 4x30mm screws per strip.

**8x40mm Screws.**

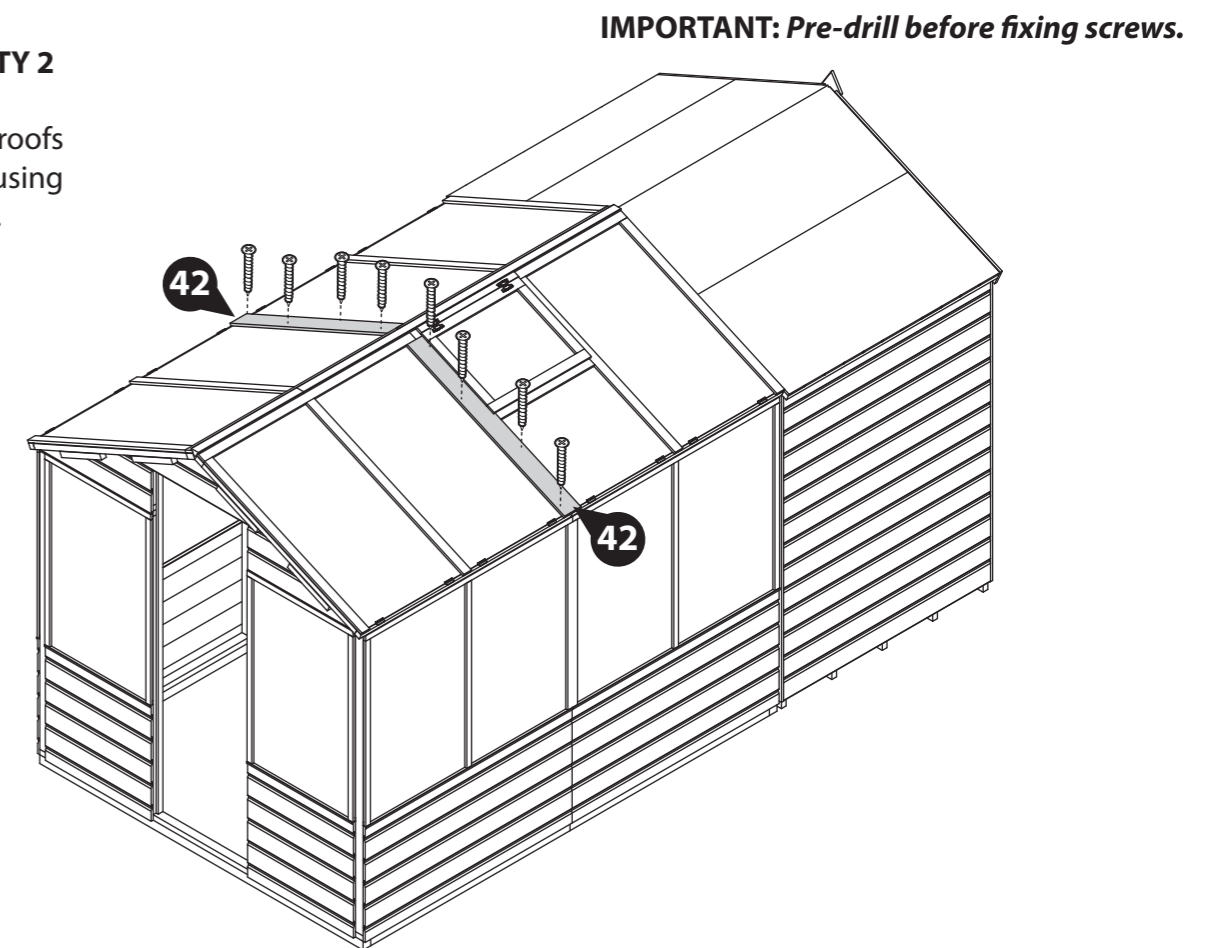

**Step 24a**

**Parts needed - No. 22 QTY 1**

Fix the Casement stay (**No. 22**) to the opening window then align the fixings onto the window panel frame. Ensure the casement stay fits onto fixings when closed before screwing them down using 6x20mm screws.

**6x20mm Screws.**

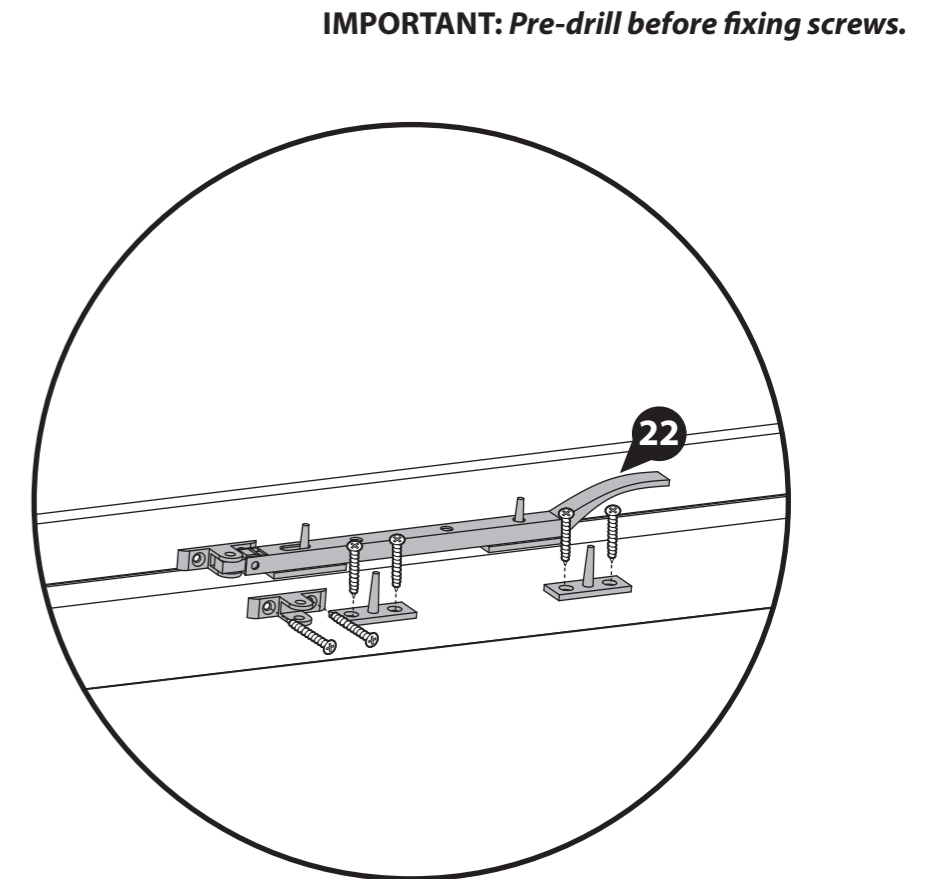

**Step 25a**

**Parts needed - No. 8 QTY 1**  
**No. 21 QTY 2**  
**No. 25 QTY 1**  
**No. 26 QTY 2**

- a** Locate the Door (**No. 8**) into the Door opening ensuring there is equal spacing on all sides.
- b** Fix the door (**No. 8**) to the building using 8x30mm black screws per hinge (**No. 21**) as shown in the diagram.
- c** Locate the Door Knob (**No. 25**) onto the door (**No. 8**). Secure in place by screwing through the door, internally, and into the door knob using 1x50mm screw.
- d** Locate one Turn Button (**No. 26**) to the top of the door and one to the bottom. Fix to the Door Side using 2x30mm black screws.

**18x30mm Black Screws.**  
**1x50mm screw.**

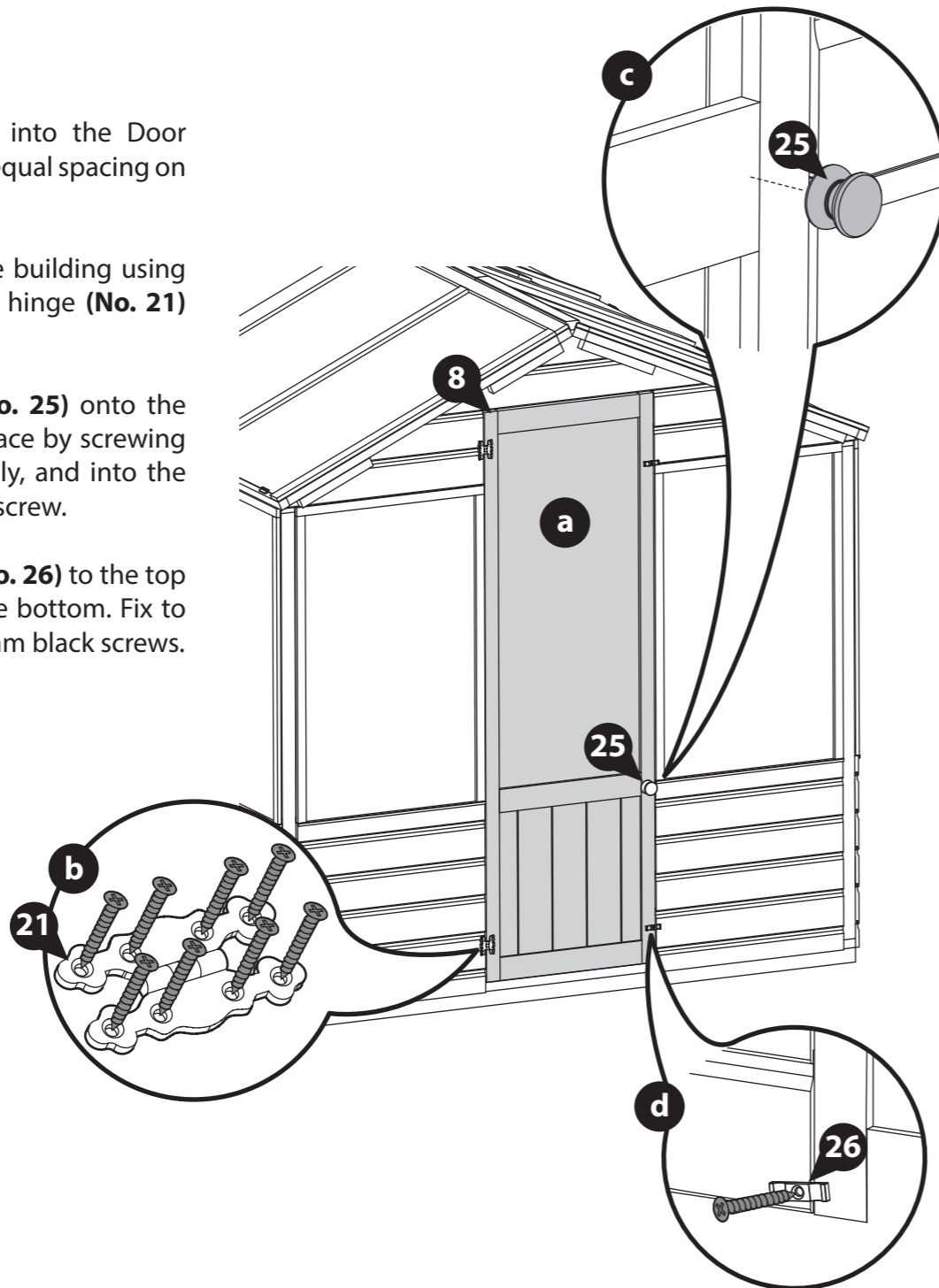
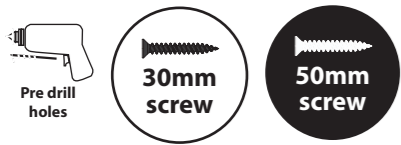

**IMPORTANT: Pre-drill before fixing screws.**

**Step 26a**

**Parts needed - No. 41 QTY 2**  
**No. 44 QTY 2**

Locate the Corner Trims (**No. 41**) onto the front corners of the building, as shown.

Fix in place using 4x30mm screws per trim.

Locate the strips (**No. 44**) onto the joins of the small window panels on each side, as shown.

Fix in place using 3x30mm screws per trim.

**14x30mm Screws**



**IMPORTANT: Pre-drill before fixing screws.**

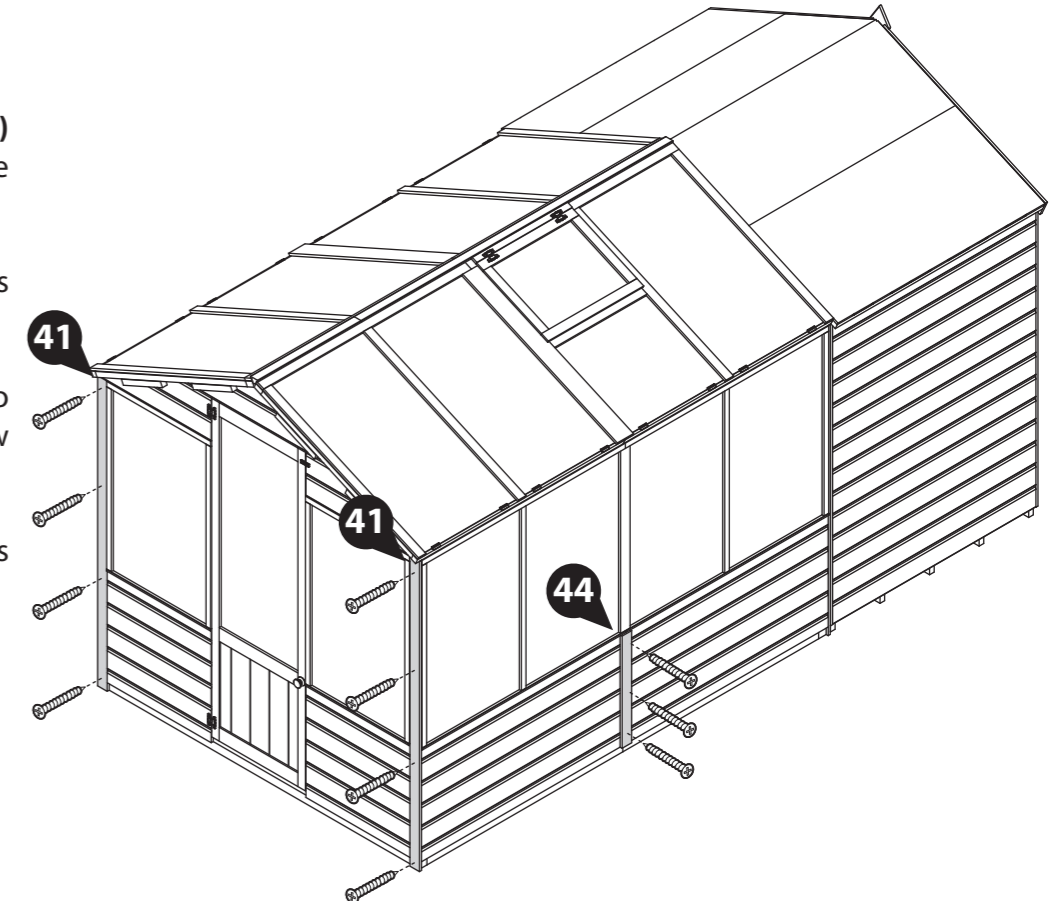

**Step 27a**

**Parts needed - No. 10 QTY 4**  
**No. 24 QTY 2**

Locate two Fascias (**No. 10**) to the front of the Greenhouse as shown. Secure in place using 3x30mm screws per Fascia.

Locate the finials (**No. 24**) on top of the Fascias (**No. 10**) and fix in place using 1x30mm screw per Finial.

Position the remaining two Fascias (**No. 10**) across the joint of the two roofs. Fix in place using 4x30mm screws, ensuring to screw through to both the shed and greenhouse roofs in an alternating pattern.

**15x30mm Screws**



**IMPORTANT: Pre-drill before fixing screws.**

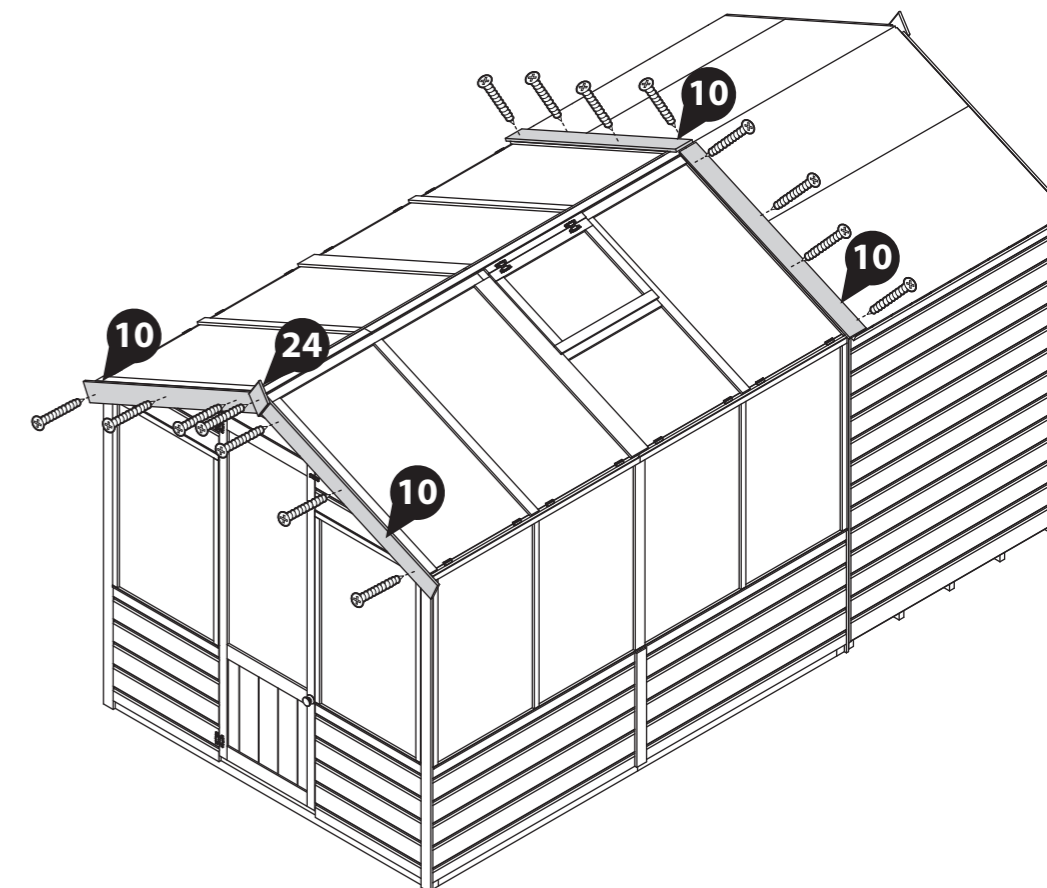

**Step 28a**

**Parts needed - No. 19 QTY 1  
No. 20 QTY 1**

Locate the Roof trims (**No. 19 & 20**) to the top of the building and secure with 6x30mm screws as shown.

**6x30mm Screws**

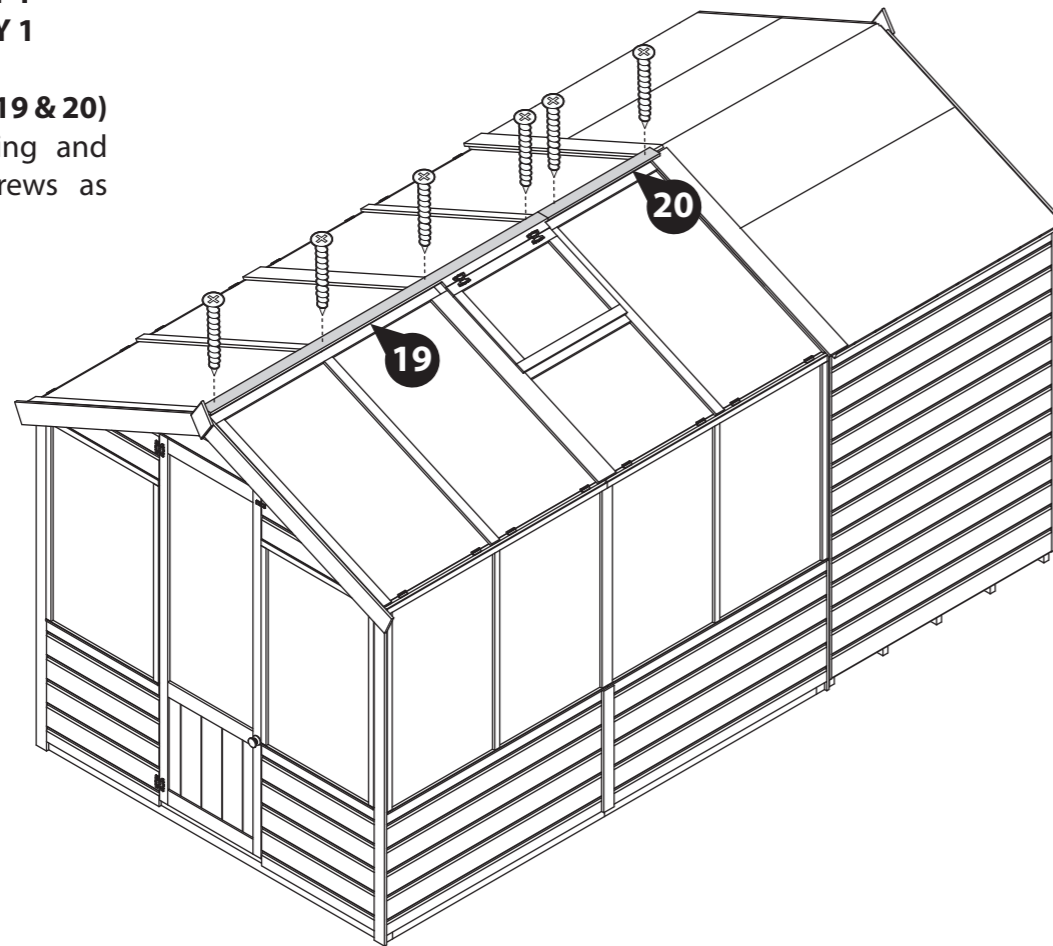

**IMPORTANT: Pre-drill before fixing screws.**

**Step 29a**

Once constructed, apply a preserving treatment and a waterproofing treatment to your garden building as soon as possible. This will help to protect your building and prevent decay.

See page 28 for a full guide and instructions.

Once fully treated, score around the protective covers on the glazing and carefully peel the covers back.

It is essential to seal around all window framing with silicone sealant (not included) to minimise water ingress.



*Apply treatment*



*Score and peel*

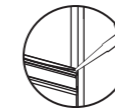

*Seal with Silicone*

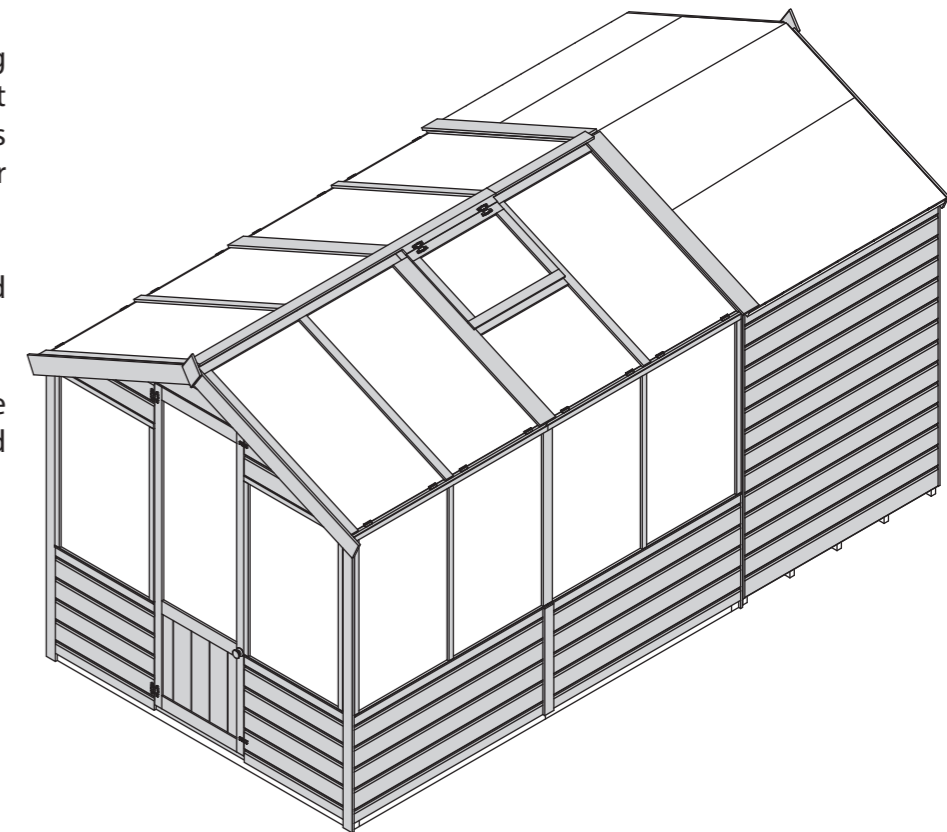
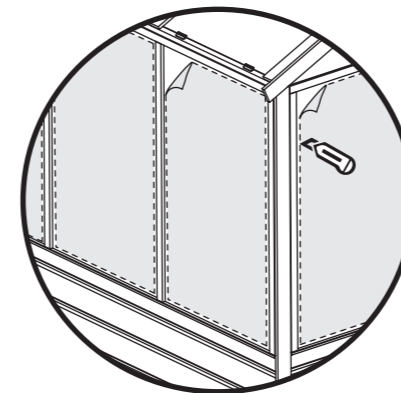

**LEAVE US A REVIEW...**



Want to share your experience with us?  
Leave us a review on Feefo, TrustPilot or Google.

Your reviews help other people find and trust our business, as well as helping to play an important role in our growth and improvement!

## TREATING YOUR GARDEN BUILDING

Preservation of wood that's outdoors is vital. A little early care will help protect your garden building, improve its appearance and ensure maximum longevity. Insects, moisture, salt, and changing weather can have dramatic effects on the stability and appearance of your garden building. Once your building is installed, you've checked it over and you're happy with it, you can take a few basic precautions to prepare it for the elements. Treating your garden building helps prevent decay and, by repelling water, discourages the growth of moulds and fungi that could jeopardise the structural integrity of the wood.

**Dip Treated buildings** - Require a preservative treatment to protect against rot and decay and a waterproof treatment to prevent water ingress  
**Pressure Treated buildings** - Require a waterproof treatment to prevent water ingress  
**Log Cabins/Insulated Garden Rooms** - Are supplied untreated and require a preservative and waterproofing treatment.



**ANY QUESTIONS?**  
Scan the QR code to contact us via our customer portal.

To apply a preservative and water proofing treatment (pressure treated products do not require a preserver), follow the manufacturer's instructions but in principle, stick to the following steps:

- ✓ Weather permitting, ensure to treat your garden building within 14 days of installation.
- ✓ Wear latex or rubber gloves, eye protection and (if spraying) a mask.
- ✓ Prepare the wood, by sanding down any ridges or inconsistencies in the wood, smoothing out knots and end-cuts.
- ✓ Choose a dry day to treat your garden building. If you're spraying rather than brushing paint on, avoid a windy day.
- ✓ Be sure you can safely reach all the sections you need to paint - and if you need a ladder, make sure it's safely positioned before climbing. Lay dust sheets around to avoid paint splatters on your base or surrounding plants.

- ✓ Tape around windowpanes to avoid smears when you're painting the frames.
- ✓ Keep pets and small children out of the way. The last thing you want is to have fur on your garden building paint, or little painted footprints all over your garden and home.
- ✓ Fill any gaps in the building's body with caulk or wood filler to prevent water and draughts getting in. Silicone based caulk is flexible and will move with the timber when temperature and humidity change. Allow to dry completely before treating. A handy tip for finding gaps is to go into your garden building and look for light leaking through joins and frames. If light gets in, then so will water.
- ✓ Liberally apply at least two coats of the treatment products with a brush or spray, taking care to allow the first coat to completely dry before applying the second.
- ✓ Make sure the solution permeates the whole of the surface area, especially around natural cracks, end cuts and nail/screw holes.



APPLY WOOD TREATMENT  
**IMMEDIATELY**  
AFTER ASSEMBLY



## 1 Perimeter

Check around the perimeter of your product to ensure there are not trees or plants that are in contact with or overhanging the building. This can affect airflow and overhanging trees, or branches can damage the roof, it is advised to keep plants at a distance.

## 2 Repair

Inspect the interior and exterior of the product to look for splits, cracks, and holes. Although this is a natural occurrence it can be prevented. A wood filler can be used to close the splits, cracks, and holes.

## 3 Roof

Check your roof regularly for tears, splits, damaged wood and fallen debris. If you notice any of this immediate repair is critical.

## 4 Doors & Windows

Expansion and contraction can cause doors and windows to stick or become difficult to open. Small adjustments to the hinge position can be made to the doors and windows to allow free movement.

## 5 Oil

Hinges can seize up over time, apply lubricant to the hinges and locks annually.

## 6 Screws & Bolts

It is advised to check all screws and bolts and tighten any loose you might find. For log cabins specifically the storm braces will require loosening. During humidity and temperature changes (seasons) to allow expansion and contraction to prevent gaping, twisting, popping, and warping.

## 7 Wash

At least once a year, give the outside of your building a good wash, to remove cobwebs, leaves, or any other dirt that may accumulate on the exterior.

## 8 Airing

Airing your product regularly prevents the build up of condensation which can cause the timber to warp, bow, boards to pop, distortion, rot and mould. Condensation can build up over time or daily, it is caused by a rise and fall in temperature.

Excessive moisture levels within your building can cause water to collect on the roofs, walls and floors internally. Leaving doors and windows open regularly can help combat the natural moisture build up.

## 9 Clean & Tidy

It is good practice to clean the inside and outside of your product regularly. Clear out the contents, sweep the floor, remove dirt and cobwebs. Check for areas of damp and investigate the cause to remove and prevent future occurrences. Check the ground around your product for build up of debris such as leaves, remove and ensure there is clear ventilation underneath the floor.

### Additional Playhouse Maintenance:

It is recommended that the following checks and maintenance are carried out at the beginning of each season as well as at regular intervals during the usage season.

- Check all nuts /bolts/ screws for tightness and tighten when required.
- Check for movement / opening of wood giving rise to protrusion of nail heads and tips.
- Check hinges.
- Replace defective parts in accordance with the manufacturers instructions.
- Check any crossbeams, suspensions and anchors.
- If a swing is included; check the swing seat, chains and ropes.

**IF THESE CHECKS ARE NOT CARRIED OUT THE ACTIVITY TOY COULD BECOME A HAZARD**

All our garden buildings have been designed and manufactured with care and attention to be the perfect addition to your outdoor space. To ensure you do get the best out of your new garden building and to increase the longevity we advise that you follow the product instructions and our manufacturer's recommendations as detailed below. Thank you for choosing a Mercia Garden product!

## 1 Choosing the most suitable location for your garden building...

A minimum of 60cm should be left around the perimeter of your garden building to allow access for maintenance, annual treatment and to allow air flow around the building.

Where possible you should avoid placing your garden building underneath large trees to prevent the tree causing damage to the building.

## 2 Preparing the base for your garden building...

All our buildings must be built on a firm, level base to ensure the longevity of the building and prevent the wood from distorting. We recommend either concrete, concrete slabs or a wooden base, such as our 'Portabase'.

The base should be slightly smaller than the external measurement of the building, i.e. the cladding should overlap the base, creating a run off for water and preventing water from pooling underneath the building.

We also recommend that the floor of the garden building is a minimum of 25mm above the surrounding ground level to avoid flooding.

## 3 After installation...

Once your garden building has been installed, it will need to be treated within 14 days (weather permitting) and annually to prevent the timber from deteriorating and to waterproof it. This is required to maintain the anti-rot guarantee.

Dip Treated buildings - Require a preservative treatment to protect against rot and decay

and a waterproof treatment to prevent water ingress.

Pressure Treated buildings - Require a waterproof treatment to prevent water ingress.

Log Cabins/Insulated Garden Rooms - Are supplied untreated and require a preservative and waterproofing treatment.

We also recommend using a silicon sealant on the inside and outside of the windows as soon as possible after assembly and treatment to fully seal the windows.

Roofing felt/covering should be checked annually and replaced or fixed accordingly.

## 4 General maintenance and wood characteristics

As wood is a natural material it may be affected by the following:

Shrinkage and warping - The timber used in the construction of your garden building will have retained some of its natural moisture content. The moisture content of the timber will vary, depending upon prevailing environmental conditions, which will result in the components either naturally expanding or contracting. As the components dry out, shrinkage may occur. A good waterproofing treatment from the start is the best protection to minimise the effect of moisture loss/intake.

In extended periods of very warm weather getting some moisture to the building will help the overall balance. You can do this by spraying it down lightly with a garden hose. In contrast, after snow fall try to remove the snow as best as possible from the roof to prevent moisture intake and to remove the extra weight.

**Top tip** - using a garden brush will help you to reach the highest part of the building to remove snow and any debris left from bad weather.

Damp and mould - During the winter months, cold and damp conditions can result in an increased amount of moisture within your garden building, especially when used infrequently. Condensation can form on the timber and other items stored within your garden building. If left this moisture is likely to cause mould and mildew.

To prevent the build-up of moisture, we recommend leaving the door or windows of your building open from time to time, to allow the fresh air to circulate. We also advise against storing wet or damp items in your garden building as this will also increase the level of moisture in the building. If mould or mildew does start to form within your building we recommend using an anti-mould cleaner to remove it and to prevent it spreading, which if left untreated could permanently damage your garden building.

Splits, cracks and knots - You may notice small splits and cracks in some components or holes may appear where knots shrink and fall out. This will not affect the structure of your Garden building however, if you wish to fill them this can be easily done using any good quality wood filler.

Sap - is naturally occurring in wood and may appear in some boards of your garden building. If you wish to remove the sap, we advise waiting until it is dry and then using a sharp knife to carefully remove it. If the removal of the sap causes a hole in the timber, we recommend using a good quality wood filler to fill it.

For more handy hints and tips on how to care and maintain your garden building please refer to the MGP Customer Portal at [www.mgplogistics.co.uk](http://www.mgplogistics.co.uk)



### Any further questions?

Contact our Customer Service Team via the MGP Customer Portal at: [www.mgplogistics.co.uk](http://www.mgplogistics.co.uk)

## 1

### Manufacturer's Warranty

All Mercia Garden Products are supplied with a 1 year warranty on all parts against manufacturing defects.

This warranty does not cover movement, warping or splitting of timber products over time.

This warranty will be voided if any of the following occur:

1. The building has been customised or modified/adapted in any way.
2. The person claiming is not the original purchaser of the building.
3. Any damage has been caused by or as a result of misuse.
4. The building has not been maintained and cared for in accordance to our advisories and manufacturer's recommendations.
5. The building has not been treated annually or as per the manufacturer's recommendations, please ensure receipts are kept to validate this claim.
6. The building has not been erected, fitted or installed as per the supplier instructions.
7. The building has not been erected on a suitable sized firm flat, solid level concrete/slab base or placed on pressure treated bearers.
8. The building is or has been placed with 2 feet (600mm) of any obstructions (walls, trees, plants, fences etc.) which can allow moisture to penetrate the timber.
9. The roofing felt has been incorrectly fitted or damaged, allowing water ingress, or has not been properly maintained.
10. Any windows and joints have not been sealed, inside and out, with silicone or other watertight sealant.
11. Any timber has been cut, pierced or drilled without subsequent application of approved cut-end treatment.

REGISTER FOR YOUR  
**10 YEAR**  
**ANTI-ROT**  
GUARANTEE TODAY



[www.mgplogistics.co.uk](http://www.mgplogistics.co.uk)

## 2

### Anti-rot Guarantee

Mercia Garden Products offer a 10 year anti-rot guarantee on all dip treated (a preparatory treatment) and 15 years on all pressure treated products. This guarantee covers solid timber against rot, decay, blue stain and insect attacks.

To validate the guarantee, the building must be treated (as detailed within manufacturer's recommendations) within 14 days (weather permitting) of assembly and annually thereafter.

This guarantee does not cover movement, warping or splitting of timber products over time.

This guarantee will be voided if any of the following occur:

1. The building has been customised or modified/adapted in any way.
2. The person claiming is not the original purchaser of the building.
3. Any damage is caused by or as a result of misuse.
4. The building has not been maintained and cared for in accordance to our advisories and manufacturer's recommendations.
5. The building has not been treated annually or as per the manufacturer's recommendations, please ensure receipts are kept to validate this claim.
6. The building has not been erected, fitted or installed as per the supplier instructions.
7. The building has not been erected on a suitable sized firm flat, solid level concrete/slab base or placed on pressure treated bearers.
8. The building is or has been placed with 600mm of any obstructions (walls, trees, plants, fences etc.) which can allow moisture to penetrate the timber.
9. The roofing felt has been incorrectly fitted or damaged allowing water ingress, or has not been properly maintained.
10. Any windows and joints have not been sealed, inside and out, with silicone or other watertight sealant.
11. Any timber has been cut, pierced or drilled without subsequent application of approved cut-end treatment.