

03DTSHCR0909FGD4TW-V2
DIP TREATED CORNER SUMMERHOUSE, 9X9, FULLY GLAZED DOOR, FOUR TALL WINDOWS.



x2 All buildings should be erected by two adults



Winter = High Moisture = Expansion
 Summer = Low Moisture = Contraction

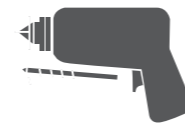

2mm Drill bit

For ease of assembly, you **MUST** pilot drill all screw holes and ensure all screw heads are countersunk.



CAUTION
 Every effort has been made during the manufacturing process to eliminate the prospect of splinters on rough surfaces of the timber. You are strongly advised to wear gloves when working with or handling rough sawn timber.



For ease of assembly, you will need a tape measure to check dimensions of components.

Screws & Nails



Measure overall length

Bolts

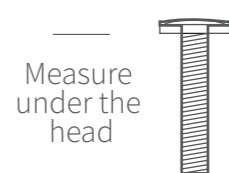

Measure under the head

To identify the fixings required for each step use a measuring tape.

****Protim Aquatan T5 (621)****

Your building has been dip treated with Aquatan.

Aquatan is a water-based concentrate which is diluted with water, the building as been treated by the correct application of Aquatan solution and then allowed to dry.

Aquatan is a decorative finish to colour the wood, which is applied industrially to timber fence panels and garden buildings.

Aquatan undiluted contains: boric acid, sodium hydroxide 32% solution, aqueous mixture of sodium dioctyl sulphosuccinat and alcohols: 2, 4, 6-trichlorophenol.

BEFORE YOU START PLEASE READ INSTRUCTIONS CAREFULLY

- Check the pack and make sure you have all the items listed in the parts list provided.
- When you are ready to start, make sure you have the right tools at hand (not supplied - see the equipment list on next page).
- Ensure there is plenty of space and a clean dry area for assembly.
- Ensure you have enough time to build the product to ensure the building is water tight.

LOCATION FOR YOUR GARDEN BUILDING

A minimum of 600mm should be left around the perimeter of your garden building to allow access for maintenance, annual treatment and to allow air flow around the building.

Where possible you should avoid placing your garden building underneath large trees to prevent the tree causing damage to the building.

TIMBER

As with all natural materials, timber can be affected during various weather conditions. For the duration of heavy or extended periods of rain, swelling of the wood panels may occur. Warping of the wood may also occur during excessive dry spells due to an interior moisture loss. Unfortunately, these processes cannot be avoided but can be helped. It is suggested that the outdoor building is sprayed with water during extended periods of warm sunshine and sheltered as much as possible during rain or snow.

Once your garden building has been installed it will need to be treated within 14 days (weather permitting) and annually to prevent the timber from deteriorating and to waterproof it. This is required to maintain the anti-rot guarantee.

Dip Treated buildings - Require a preservative treatment to protect against rot and decay and a waterproof treatment to prevent water ingress

Pressure Treated buildings - Require a waterproof treatment to prevent water ingress

Log Cabins/Insulated Garden Rooms - Are supplied untreated and require a preservative and waterproofing treatment.

BUILDING A BASE

When thinking about where the building and where the base is going to be constructed: Ensure that there will be access to all sides for maintenance work and annual treatment.

Ensure the base is level and is built on firm ground, to prevent distortion. Refer to diagrams for the base dimensions, The base should be slightly smaller than the external measurement of the building, i.e. The cladding should overlap the base, creating a run off for water. It is also recommended that the floor be at least 25mm above the surrounding ground level to avoid flooding.

TYPES OF BASE

- Concrete 75mm laid on top of 75mm hard-core.
- Slabs laid on 50mm of sharp sand.
- Wooden base.

Whilst all products manufactured are made to the highest standards of safety and in the case of children's products independently tested to EN71 level, we cannot accept responsibility for your safety whilst erecting or using this product.

REGISTER FOR YOUR
ANTI-ROT
 GUARANTEE TODAY

PLEASE SCAN HERE:

In all instances for assistance with your product, please contact us via our customer portal: <https://www.mgplogistics.co.uk/>.

Mercia Garden Products Limited,
 Sutton On Trent,
 Newark,
 Nottinghamshire,
 NG23 6QN

TO DO LIST

- Find a suitable location to build *(see front cover for further information).*
- Build a base *(see front cover for further information).*
- Check the base is flat, level, clear of debris and has 60cm clearance on all sides.
- Check you have the required equipment.
- Check you have all the product items listed *(if you have missing or damaged parts please contact the customer services department, see front cover for contact details).*
- Install the product as per the step by step instructions within this pack.
- Prepare the product ready for treatment.
- Apply a preserving and a waterproofing treatment within 14 days *(weather permitting)* of installation *(pressure treated products do not require a preserver).*
- Register for your anti rot guarantee *(scan the QR below).*
- Tidy the build area and dispose of any remaining parts responsibly.
- Maintain your building *(see the manufacturers recommendations at the back of this pack).*

EQUIPMENT LIST

- Hammer
- Flat Head Screwdriver
- Drill
- Drill Bit Set
- Phillips and Slotted Bit Sets
- Tape Measure
- Hand Saw
- Spirit Level
- Ladders/Steps
- Stanley Knife/Cutting Tool
- Sand Paper
- Gloves
- Silicone (For Windows Only)
- Wood Filler (Optional)
- Timber Preservative Treatment *(not pressure treated products)*
- Timber Water Proofing Treatment
- Treatment Mixing Stick
- Paint Brush/Sprayer/Roller

NEED EXTRA SUPPORT

If you are unsure that your base preparation will be suitable, please contact us on 01636 821215 to discuss this further.

Alternatively, you can visit our website or MGP Logistics Online Portal for some further shededucation.

Website:

<https://www.merciagardenproducts.co.uk/sheducation>

MGP Logistics Online Portal:

<https://www.mgplogistics.co.uk/>

Here you will find plenty of useful information that'll help with most pre-installation and maintenance queries.

PLEASE SCAN HERE:



ANY QUESTIONS?

Scan the QR code to contact us via our customer portal.

NOTES

ACCESSING VIDEO GUIDES...

Some steps within this set of instructions come with an added video guide for your convenience. These can be accessed via the QR code and used to aid you in constructing that step. See below for how to use.

You can also find all the videos on our youtube channel:
<https://www.youtube.com/@merciagardenproducts8716/videos>

1. Find the QR code within the instruction step...

Step.....

Parts Needed- No. QTY 1
No. QTY 1
No. QTY 1



Within the instruction step, there will be an icon in the top right that has a QR code in. This is where the video can be accessed from.

Please note: not every step has a video guide.

2. Open camera app...

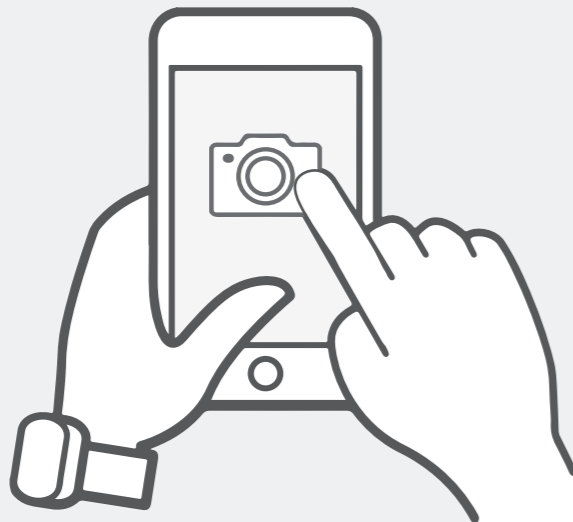

On your personal smart device (phone, tablet etc), open your camera app or QR code scanner app.

ACCESSING VIDEO GUIDES...

3. Scan QR code...



To scan the QR code, hold the camera over the QR code so that it can be seen on the screen. Once the QR code has been registered, follow the prompts on your device to open the video. (This will vary depending on your device.)

Please note: Ensure to use the back camera of your smart device as this will scan the QR code more accurately.

4. Watch the video...



The video guide will now be displayed on your smart device.

Disclaimer: The garden building constructed in the video guides may be constructed differently to your building. Please ensure to read your instructions carefully to avoid error.

Before assembly please make sure you have a suitable base ready to erect your building



MADE IN GREAT BRITAIN

Overall Dimensions: Width = 3164mm
Depth = 2918mm
Height = 2146mm
Base Dimensions: Width = 3033mm
Depth = 2799mm

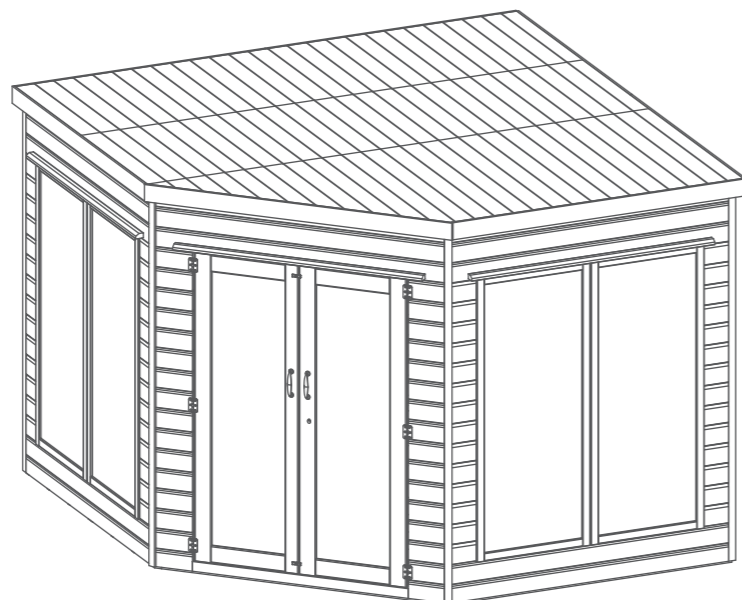

Contents:

1

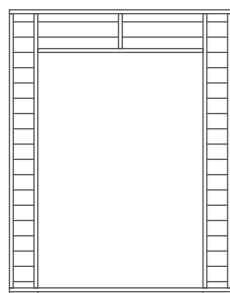

Door Panel QTY 1

AI-03S11SHDD1627X2092-V1

2

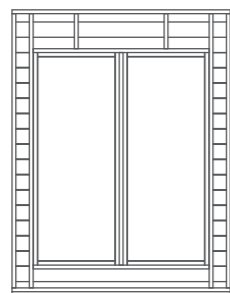

Window Panel QTY 2

AI-03S11SH2TFWC1600X2092-V1

3

Green Label

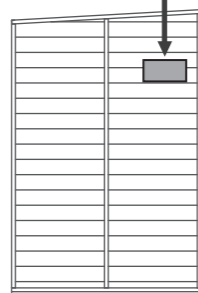

Large Right Panel QTY 1

AI-03S11SHPGR1389X2094-V1

4

Green Label

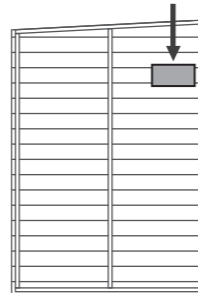

Small Right Panel QTY 1

AI-03S11SHPGR1417X2017-V1

5

Blue Label

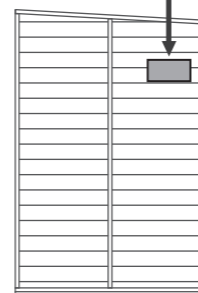

Large Left Panel QTY 1

AI-03S11SHPL1389X2094-V1

6

Blue Label

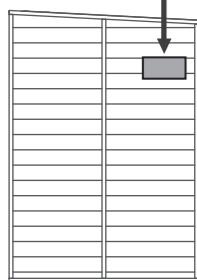

Small Left Panel QTY 1

AI-03S11SHPL1417X2017-V1

7



Floor 648x2800mm QTY 2

AI-R11MBF648X2800-V1

8

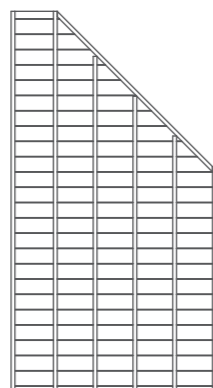

Angled Floor 1503x2800mm QTY 1

AI-R11MBAF1503X2800-V1

9

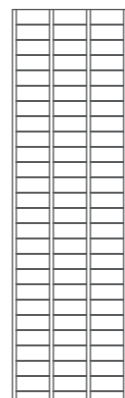

Roof 843x2889mm QTY 2

AI-S11MBPR843X2889-V1

10

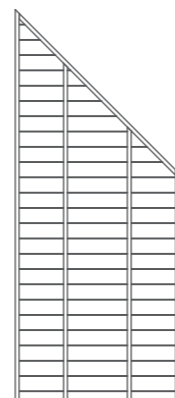

Angled Roof 1204x2889mm QTY 1

AI-S11MBANGRR1204X2889-V1

11

Green Label



Master Door QTY 1

AI-STDFGMD603X1715-V1

12

Blue Label

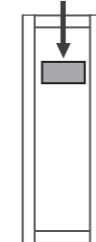

Secondary Door QTY 1

AI-STDFGSD603X1715-V1

13



Locating Block 28x28x239mm QTY 2

FS2828-239mm

14



Door Strip 12x40x1261mm QTY 1

S1240-1261mm

15



Door Strip 12x40x1740mm QTY 2

S1240-1740mm

16

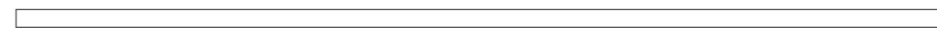

Cover Trim 12x40x2105mm QTY 4

S1240-2105mm

17



Cover Trim 12x40x2008mm QTY 2

S1240-2008mm

18

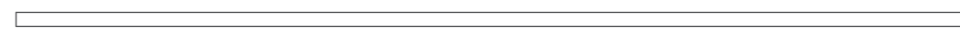

Panel Joint Frame 28x28x1920mm QTY 1

FS2828-1920mm

19



Roof Support Bar 44x58x2740mm QTY 1

F4458-2740mm

20



Fascia 12x95x1445mm QTY 4

S1295-1445mm

21



Fascia 12x95x1689mm QTY 2

S1295-1689mm

22



Fascia 12x95x1725mm QTY 1

S1295-1725mm

23



Rear Roof Frame 28x28x2888mm QTY 1

FS2828-2888mm

24



Front Roof Frame 28x28x1678mm QTY 1

FS2828-1678mm

25



Rear Cover Trim 12x60x1915mm QTY 2

S1260-1915mm

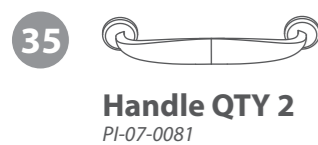
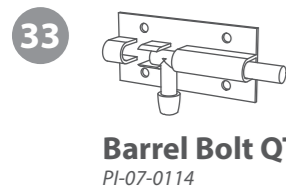
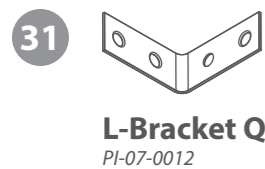
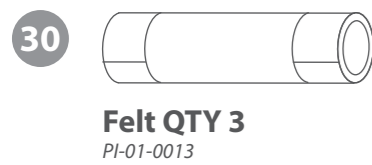
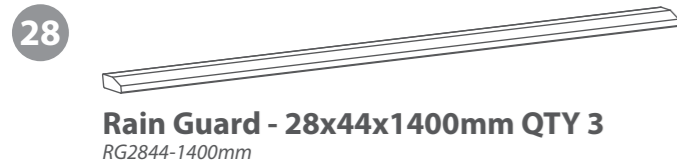

Nail Bag

There may be extra screws present in the nail bag



Pre Assembly

Before assembling remove the transportation blocks from the bottom of each panel.

Take care removing the blocks as to not damage the panels. Tap with a flat headed screwdriver and hammer.

Dispose of the blocks once removed.

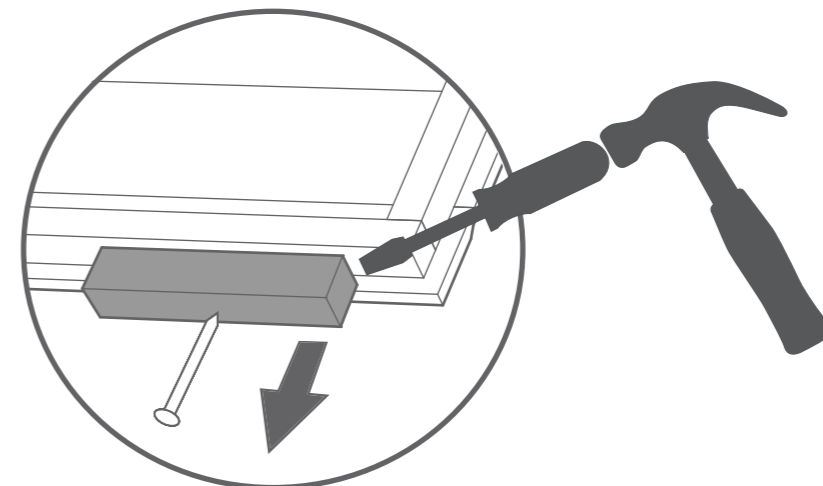

Step 1

Parts needed - No.1 QTY 1
 No.11 QTY 1
 No.12 QTY 1
 No.32 QTY 6

Lay the Door Panel (No.1) on a flat surface and place the doors (No.11 and No.12) within the Door Panel aperture. Position the doors so that they are equally spaced within the opening and interlock as shown.

Fix the Butt Hinges (No.32) onto the door and Door Panel as shown. Ensure that the screws go through the cladding and into the framing behind.

****PLEASE NOTE**** Before fitting the hinges, ensure the inner door framing is the correct way round as shown in the illustration.

36x25mm Screws



Step 2

Parts needed - No.3 QTY 1
 No.4 QTY 1
 No.5 QTY 1
 No.6 QTY 1

Fix Large Right Panel (No.3) to Small Right Panel (No.4) and Fix Large Left Panel (No.5) to Small Left Panel (No.6) using 4 50mm screws per join.

8x50mm Screws

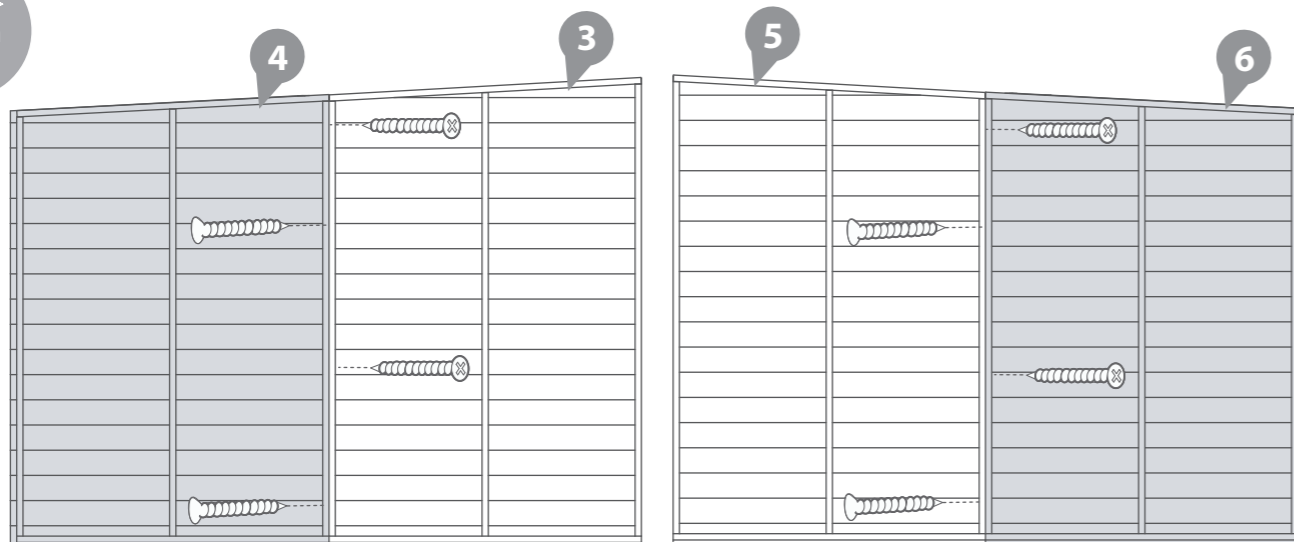

IMPORTANT: Pre-drill before fixing screws.

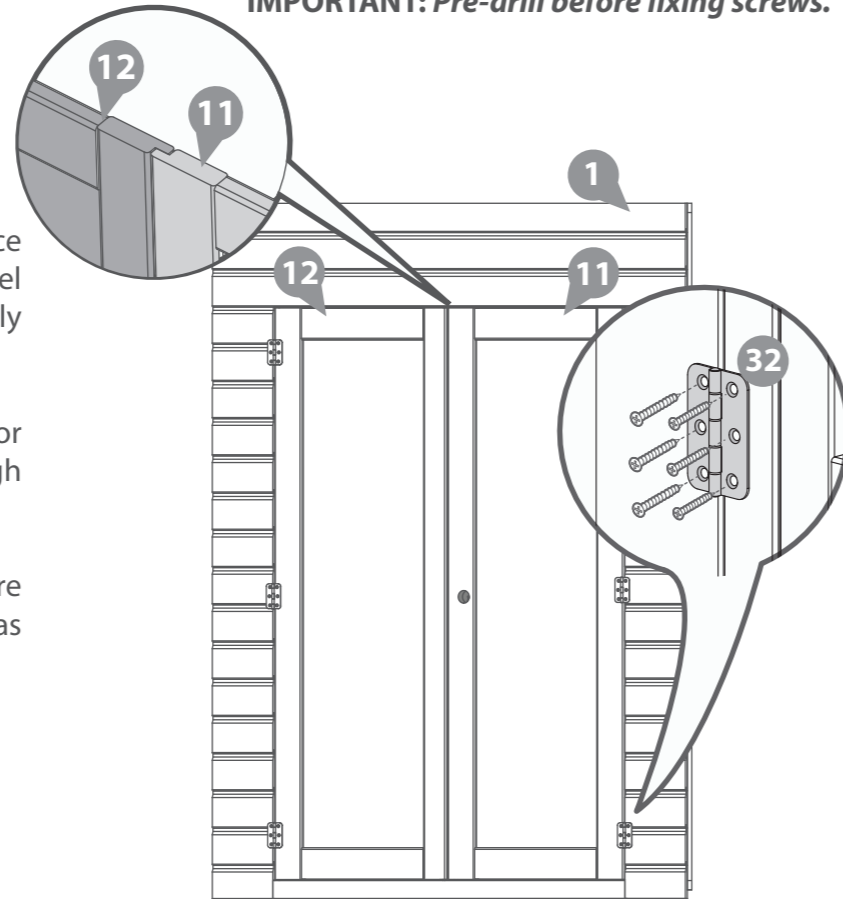

IMPORTANT: Pre-drill before fixing screws.

Step 3

Parts needed - No.7 QTY 2
 No.8 QTY 1

Place floors (No.7 & No.8) on a firm and level base, ensure base has suitable drainage free from areas where standing water can collect. (See front page on base requirements).

Fix the three floor panels together as shown using 50mm screws at an angle and alternate the positions.

12x50mm Screws

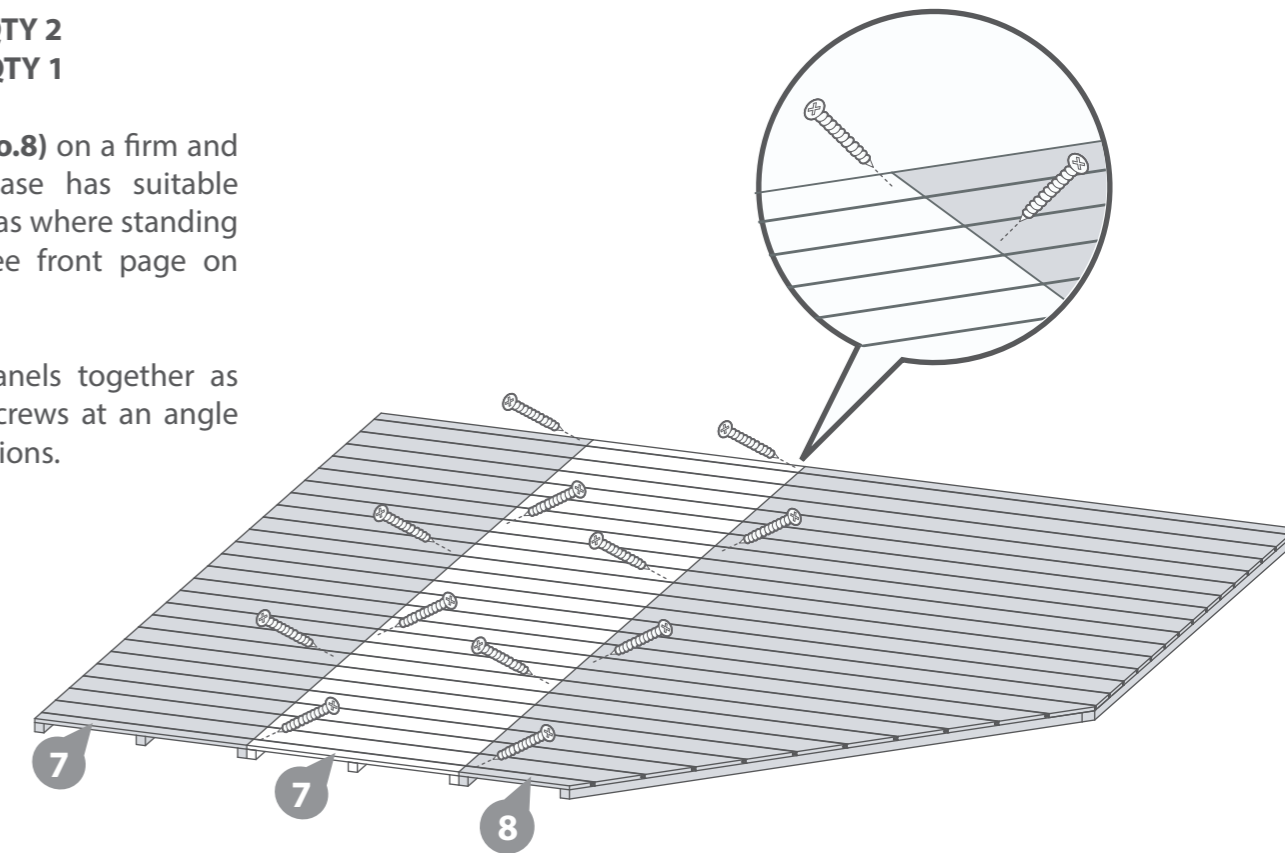
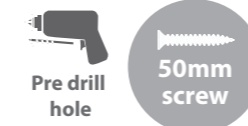

IMPORTANT: Pre-drill before fixing screws.

Step 4

Parts needed - No. 1 QTY 1
 No. 2 QTY 2

Place the Door Panel (No. 1) and the Window Panels (No. 2) onto the floor.

Fix the corners with 3x60mm screws as shown in the illustration.

Do not secure the building to the floor until the roof is fitted.

6x60mm Screws

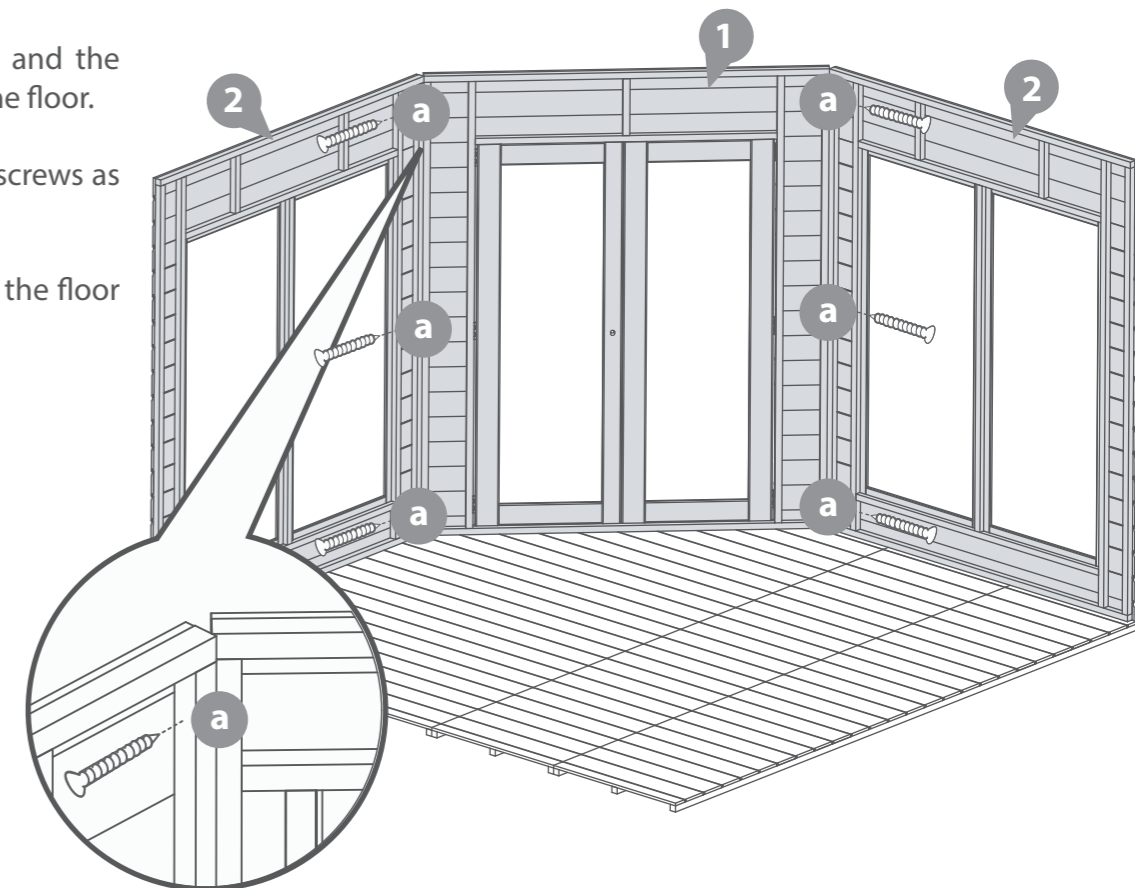
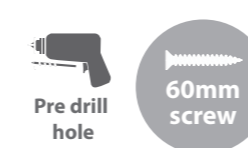

IMPORTANT: Pre-drill before fixing screws.

Step 5

Parts needed - No.5 QTY 1
No.6 QTY 1
No.18 QTY 1

Place the two already assembled Left Panels (No.5 and No.6) against the floor and the Window Panel.

Fix the corners with 3x50mm screws as shown in the illustration.

Attach the Panel Joint Frame (No.18) into place with 3x50mm screws.

Do not secure the building to the floor until the roof is fitted.

6x50mm Screws



50mm screw

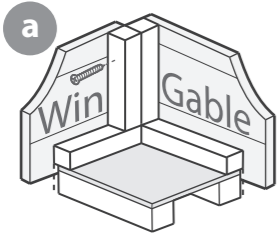

IMPORTANT: Pre-drill before fixing screws.

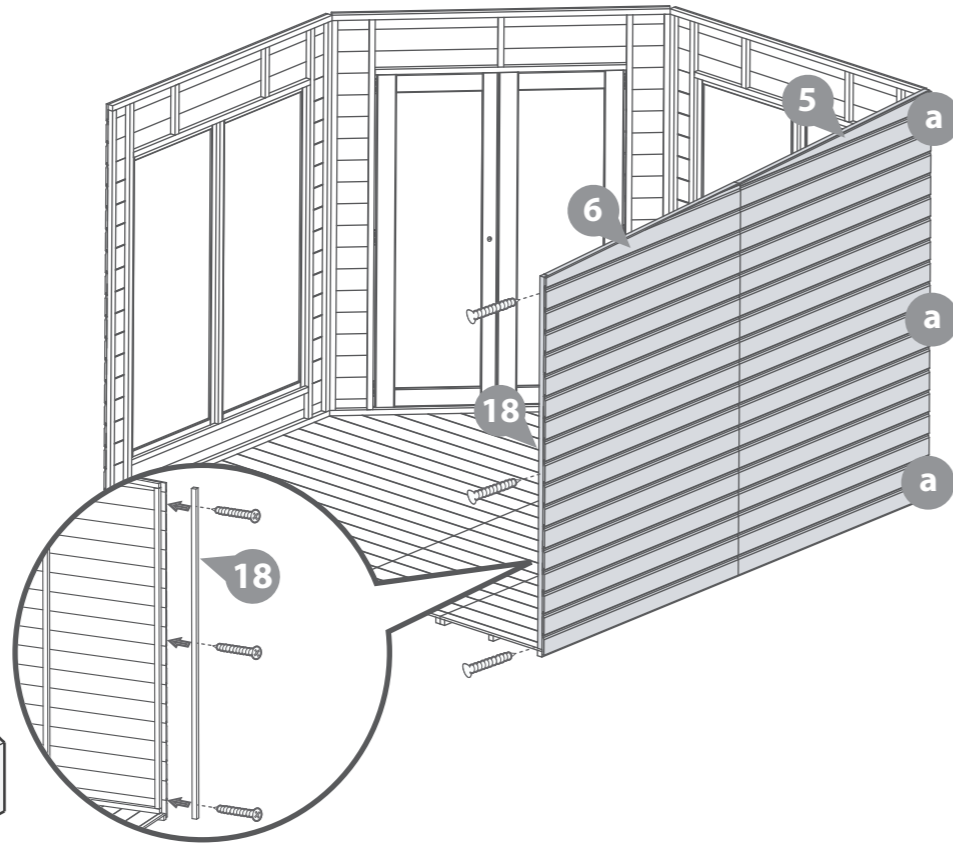

Step 7

Parts needed - No. 26 QTY 1
No. 27 QTY 1

Place the Rear Panel Framing (No.26) on top of the Right Panels. Fix in place using 4x50mm screws.

Place the Front Panel Framing (No.27) on top of the Window Panel. Fix in place using 3x50mm screws.

7x50mm Screws



Pre drill hole

50mm screw

IMPORTANT: Pre-drill before fixing screws.

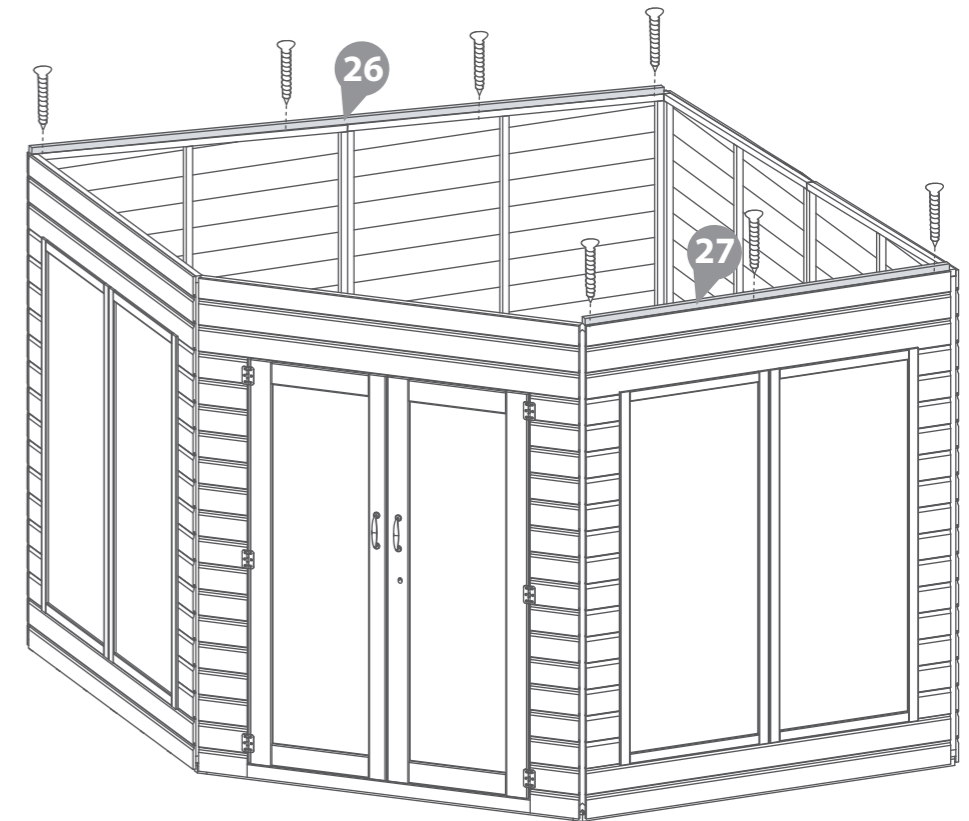

Step 6

Parts needed - No. 3 QTY 1
No. 4 QTY 1

Using the same method outlined in Step 5 place the two already assembled Right Panels (No.3 & No.4) against the floor and other Panels securing using 6x50mm screws.

From the inside fix the corners with 3x50mm screws as shown in the illustration.

Do not secure the building to the floor until the roof is fitted.

6x50mm Screws



50mm screw

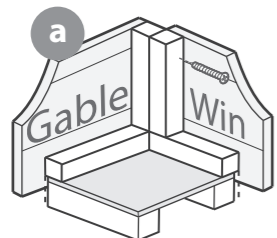

IMPORTANT: Pre-drill before fixing screws.

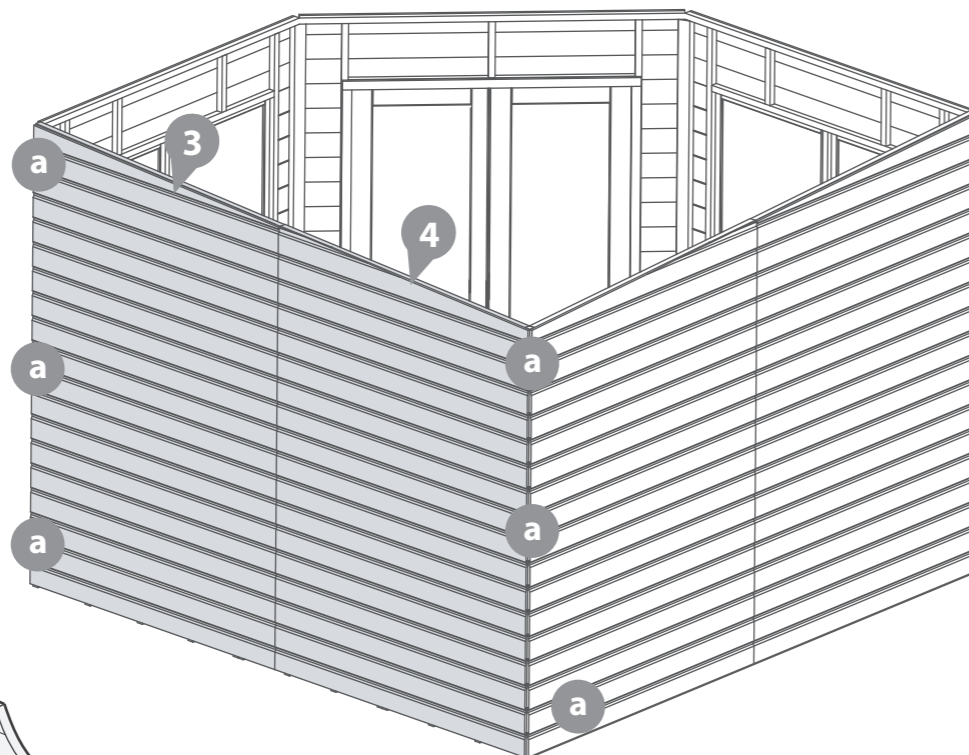

Step 8

Parts needed - No.19 QTY 1
No.31 QTY 2

Fix an L bracket (No. 31) flush to each end of the roof support (No. 19) using 2x30mm screws for each bracket. Position the roof support (No. 19) in-between the left gables and the window panel opposite.

Line the roof support up so it sits centrally at the panel join and fix in place with 2x30mm screws. Make sure the roof support sits centrally to the window upright shown in the illustration. Fix in place with 2x30mm screws.

8x30mm Screws



Pre drill hole

30mm screw

IMPORTANT: Pre-drill before fixing screws.

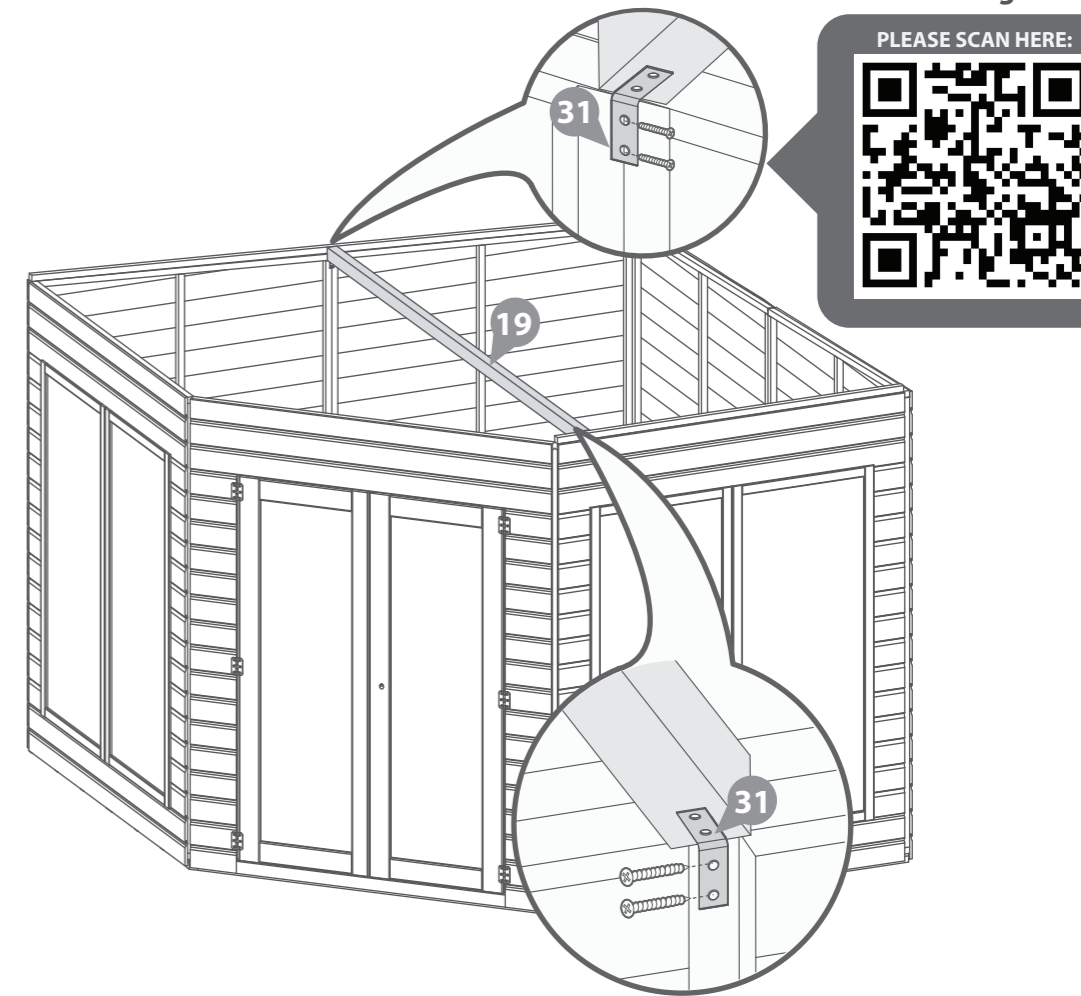

PLEASE SCAN HERE:



Step 9

Parts needed - No.9 QTY 2
No.10 QTY 1

Layout the Roof Panels (No.9 & No.10) on a flat level surface and position them as shown in the diagram. Secure the panels together using 50mm screws and alternate the positions.

12x50mm Screws

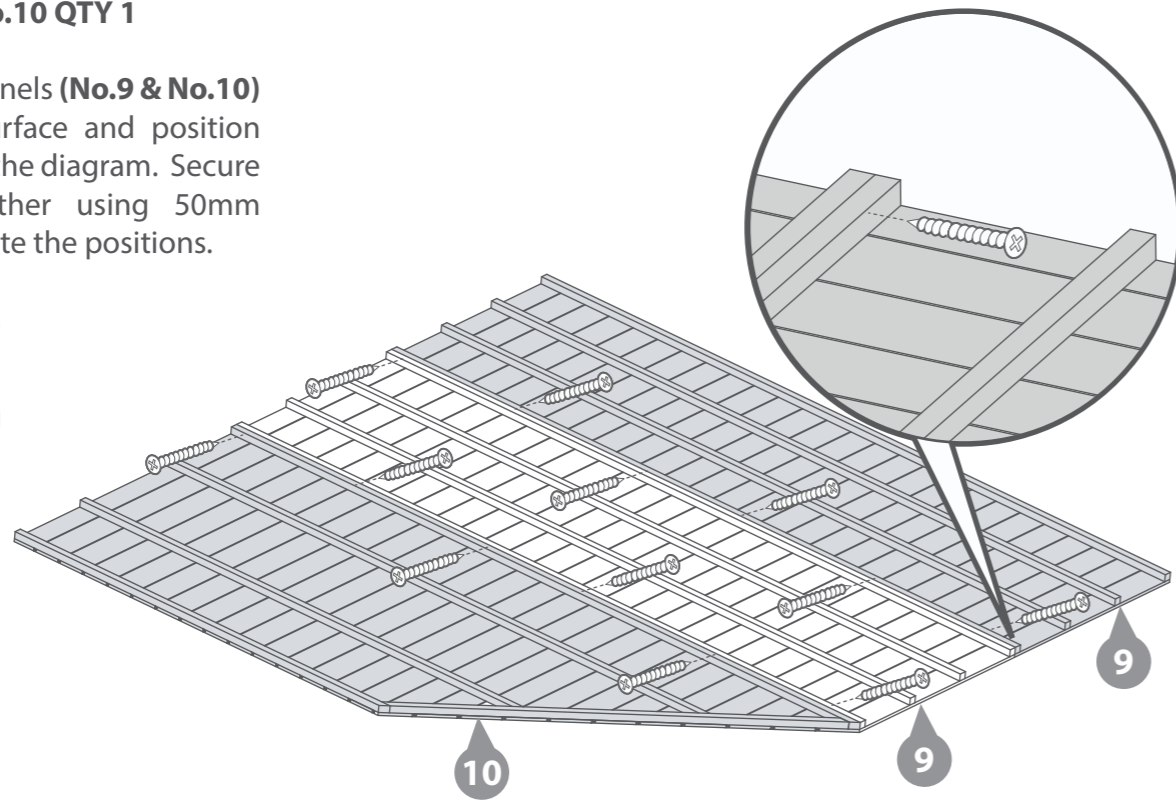
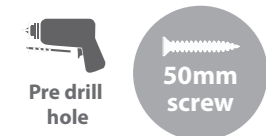

IMPORTANT: Pre-drill before fixing screws.

Step 11

Parts needed - No.9 QTY 2
No.10 QTY 1

Place all Roof sections (No.9 & No.10) on top of the building, ensure the roof framing slots over each side equally all the way around.

Fix the Roof Panels into position using 50mm screws, ensuring there is no more than 300mm between each screw.

Make sure that the screws line up with the vertical framing inside the building and along the length of the internal roof support bar.

33x50mm Screws

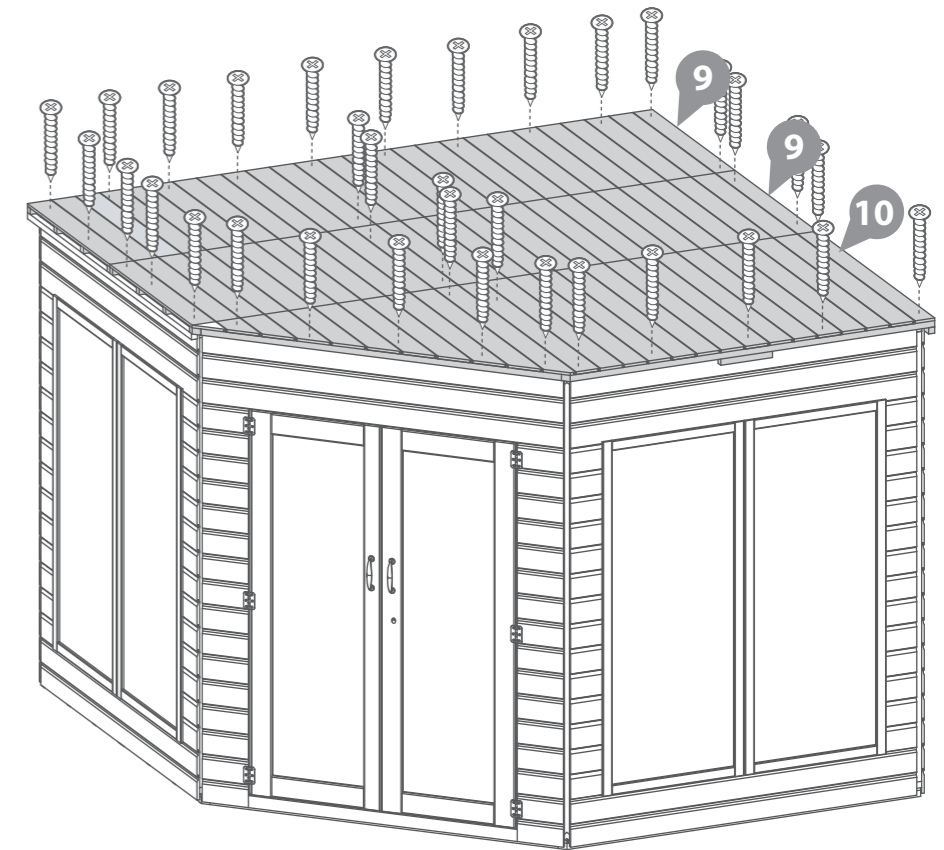

IMPORTANT: Pre-drill before fixing screws.

Step 10

Parts needed - No.13 QTY 2
No.23 QTY 1
No.24 QTY 1

Attach the front (No.24) roof framing to the roof as shown in the illustration using 3x30mm screws.

Attach the rear (No.23) roof framing to the roof as shown in the illustration using 5x30mm screws.

*Ensure to fix the framing the opposite direction to the roof bearers.

Fix the Locating Blocks (No.13) to the opposing sides to the roof framing (these blocks are to help square the roof when fitted).

12x40mm Screws

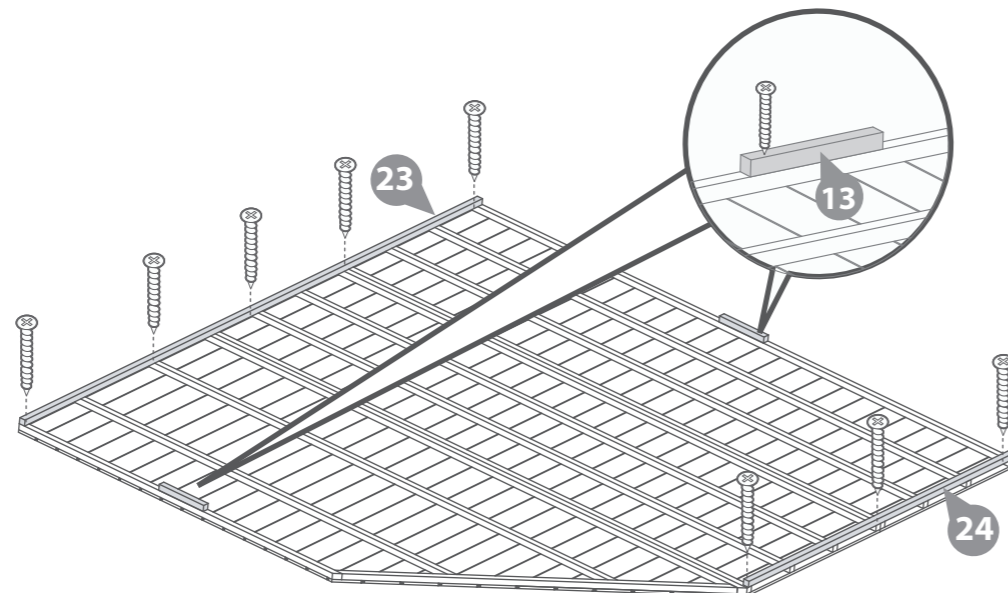

IMPORTANT: Pre-drill before fixing screws.

Step 12

Further secure the Roof Panels in place using 30mm screws. Ensure to screw through the cladding with no more than 300mm between each screw.

28x30mm Screws

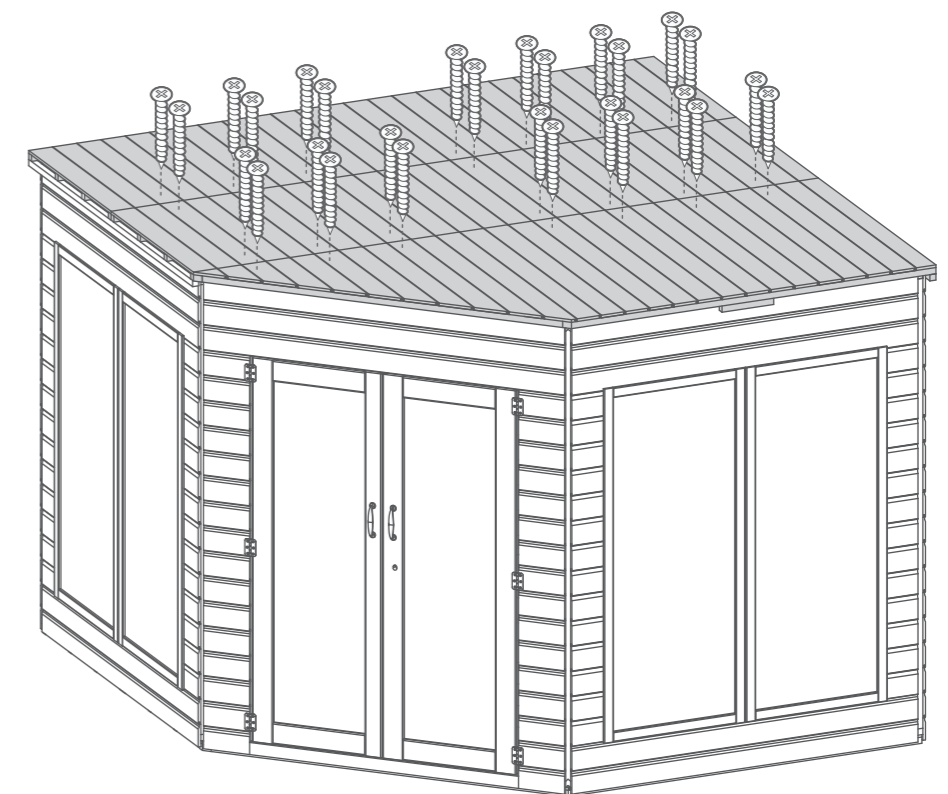

IMPORTANT: Pre-drill before fixing screws.

** If the Shed add on pack has been purchased, **do not fit No.23**, the rear roof framing, until instructed to do so in the Shed add on Pack instructions**

Step 13

Secure the building to the floor. Fix the panels onto the floor using 50mm screws in alignment with the floor joists

**Ensure to screw through the framing into the floor bearers.*

29x50mm Screws

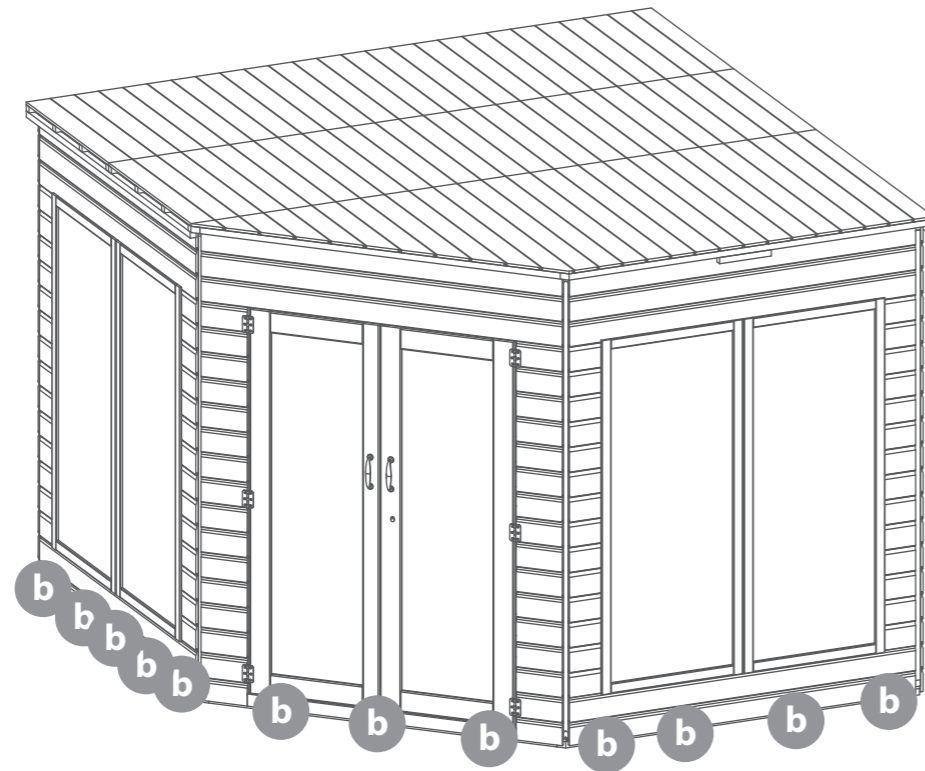

IMPORTANT: Pre-drill before fixing screws.

Step 15

Parts needed - No. 29 QTY 2
- No. 35 QTY 2

Fix the door handles (No.35) to the outside of the master and secondary door using the 35mm bolts provided.

Fix the Turn buttons (No.29) at the top and bottom of the secondary door using 2x30mm screws.

2x30mm Screws 4x35mm Bolts

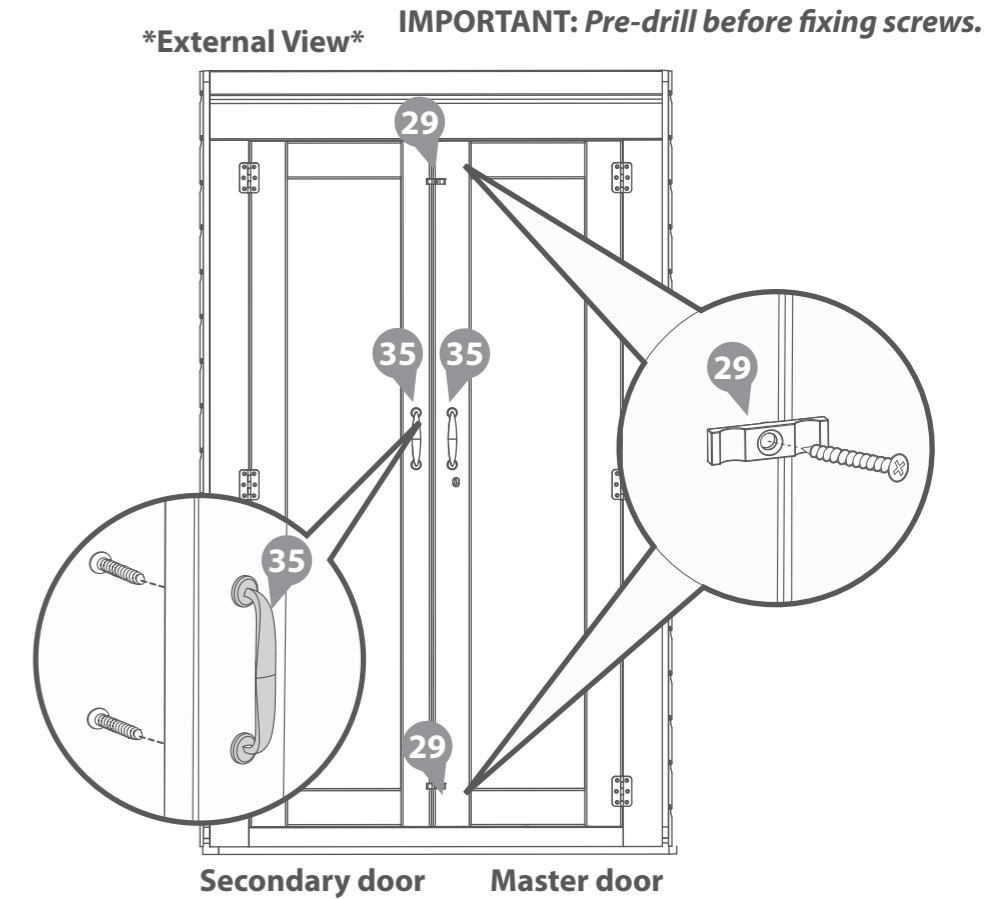

External View

IMPORTANT: Pre-drill before fixing screws.

Secondary door Master door

Step 14

Parts needed - No.14 QTY 1
- No.15 QTY 2

Fit the Door Strip (No.14 & No.15) to the framing of the door panel, secure using 3x30mm screws per strip

9x30mm Screws

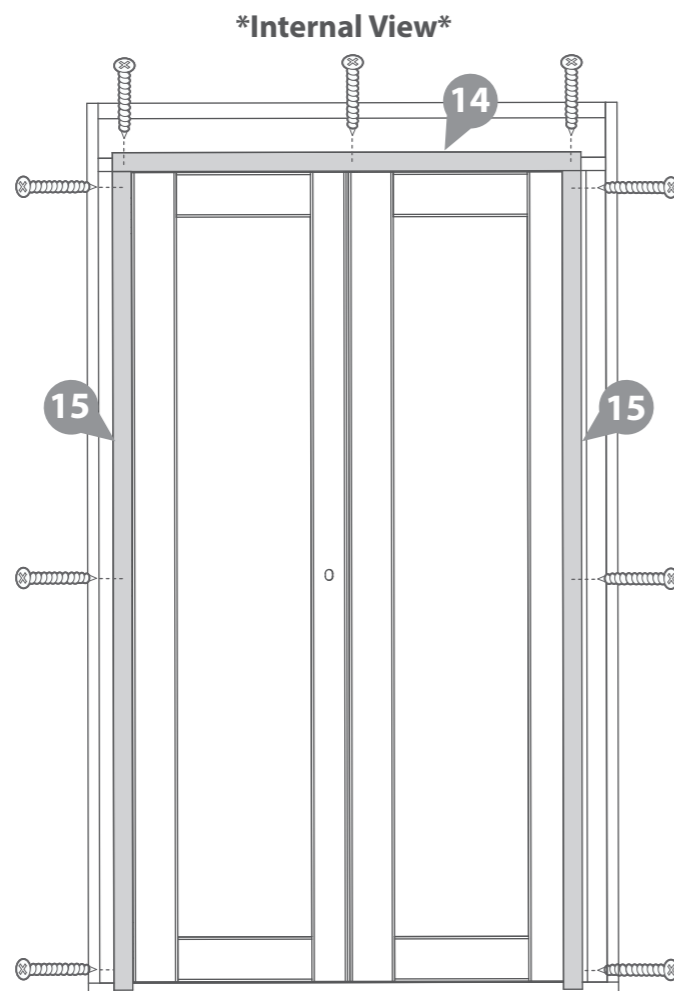
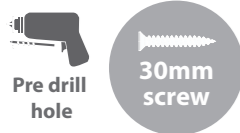

IMPORTANT: Pre-drill before fixing screws.

Internal View

Step 16

Parts needed - No. 33 QTY 2
No. 34 QTY 1

a Attach the press lock (No.34) to the master door with 4x25mm screws, aligning the barrel with the key hole.
**Ensure the key turns and locks properly before fixing to the door.*

b Place the Tower Bolts (No.33) roughly into position at the top/bottom of the secondary door. With a pencil mark around the bolt.

c After marking the bolt onto the panel, drill a hole for the barrel bolt to locate into.

Following the hole being drilled, place the tower bolts into position and secure using 4x10mm screws per bolt.

8x10mm Screws 4x25mm Screws

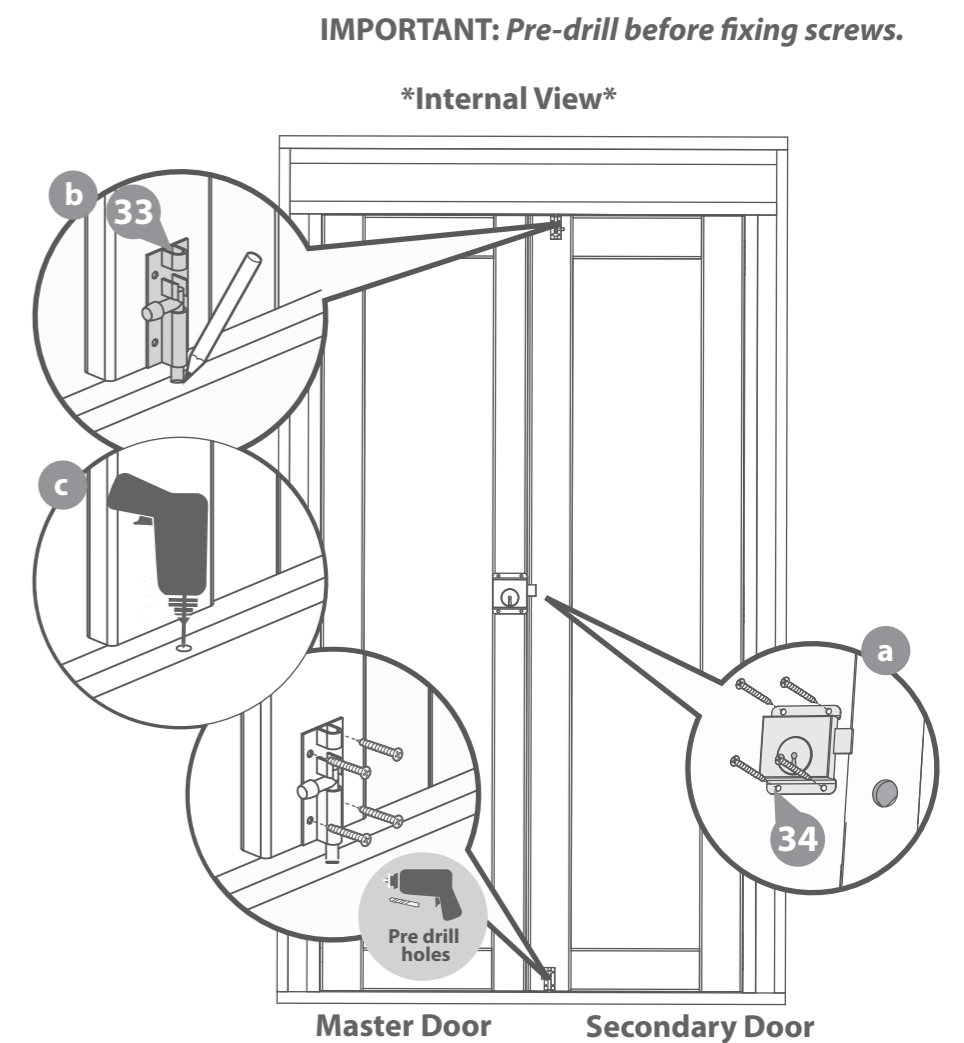

IMPORTANT: Pre-drill before fixing screws.

Internal View

Master Door Secondary Door

****If Shed add on Pack has been purchased, please move onto the Add on Pack Instructions****

Step 17

Parts needed - No. 30 QTY 1

Cut four strips from the rolls of felt (No.30):

- 2 x 430cm (L) X 100cm (W)
- 1 x 350cm (L) X 100cm (W)
- 1 x 150cm (L) X 100cm (W)

Place the felt on top of the roof and align as shown in diagram ensuring each strip overlaps the next by 20cm. Ensure all strips over hang roof by 5cm.

Ensure strip 1 is the first piece placed down then lay sheet 2, 3 and then 4 on top.

Cut the sides as shown in diagram at the dotted lines, use fascia width as guide for overhang.

Fix each sheet using felt tacks along where sheet overlap. Use felt tacks at 100mm intervals.

200 x Felt Tacks

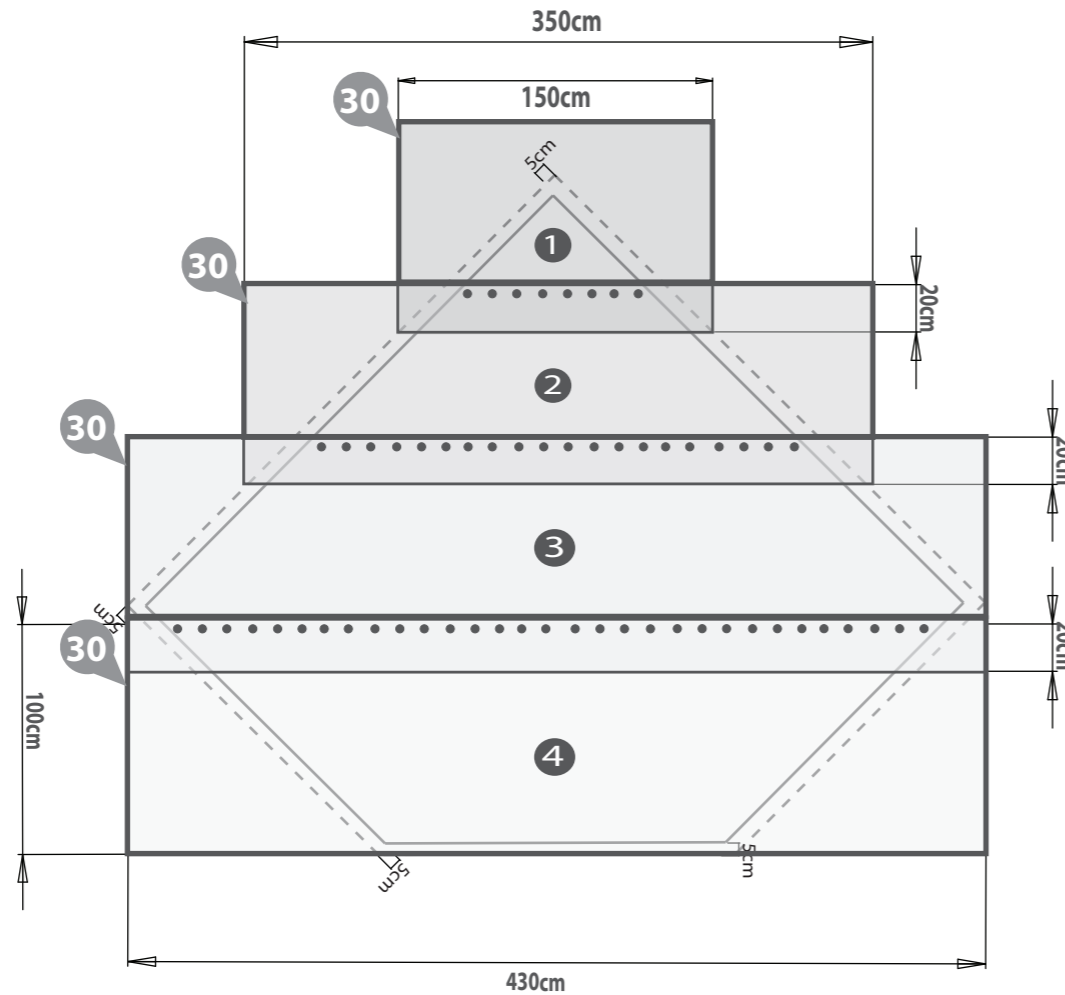

Please note: It is advisable to place a board across the length of the roof to kneel on whilst felting.

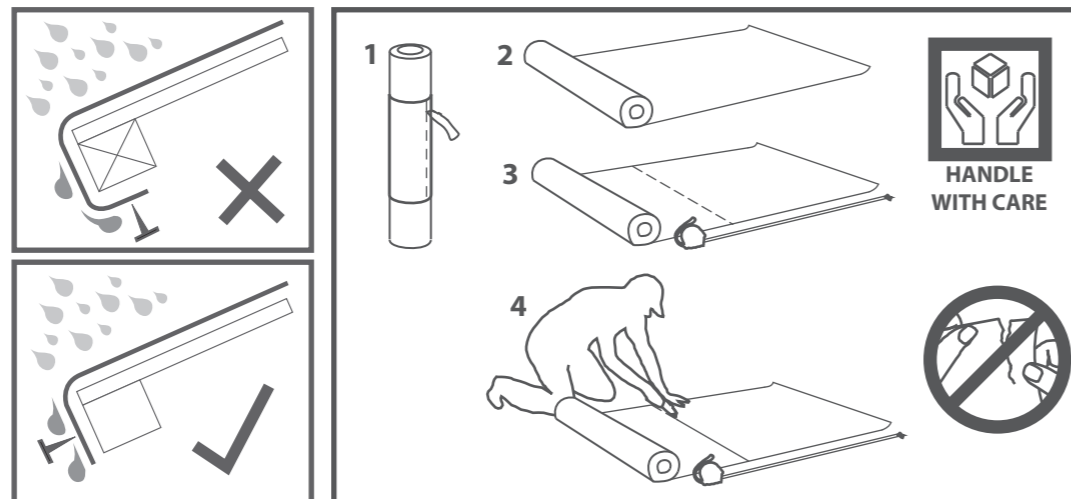

Step 18

Parts needed - No. 16 QTY 4

Fit the Cover Trims (No.16) to the front of the building onto the joins of the panels, secure using 3x30mm screws per cover trim.

12x30mm Screws

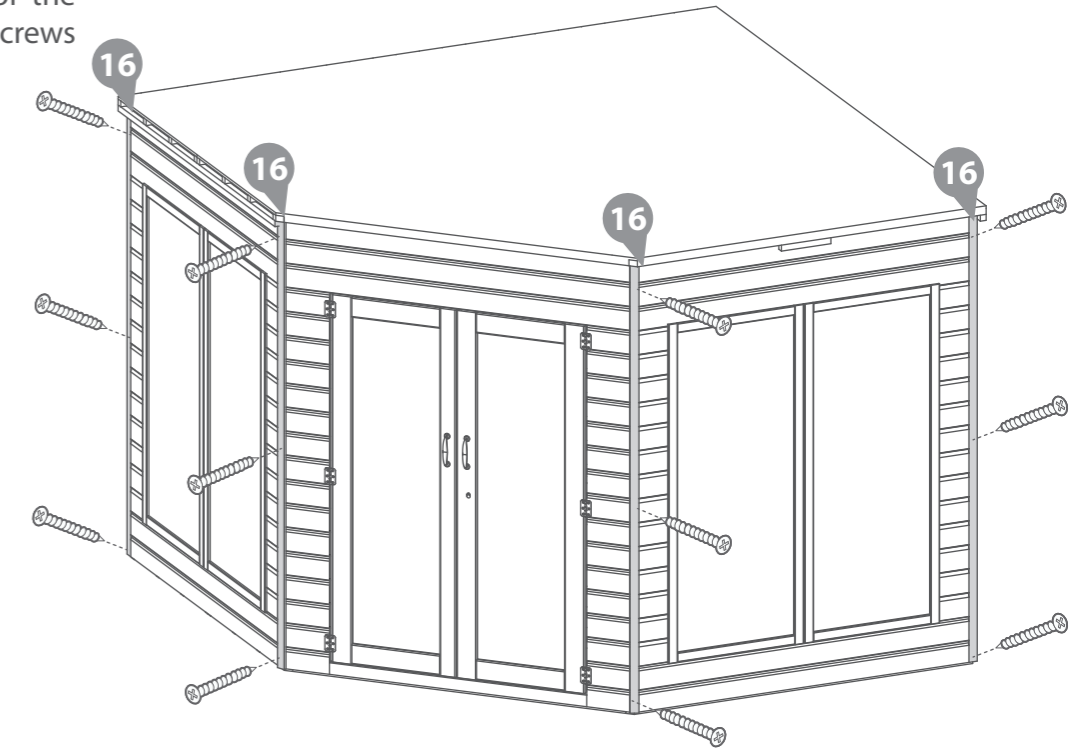
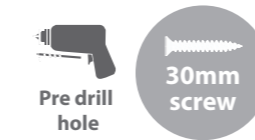

IMPORTANT: Pre-drill before fixing screws.

Step 19

Parts needed - No. 17 QTY 2
- No. 25 QTY 2

Fit the Cover Trims (No.17) to the back of the building onto the joins of the panels, secure using 3x30mm screws per cover trim.

Fix the rear cover trims (No.25) to the back of the building, aligning with the edge of the panel.

12x30mm Screws

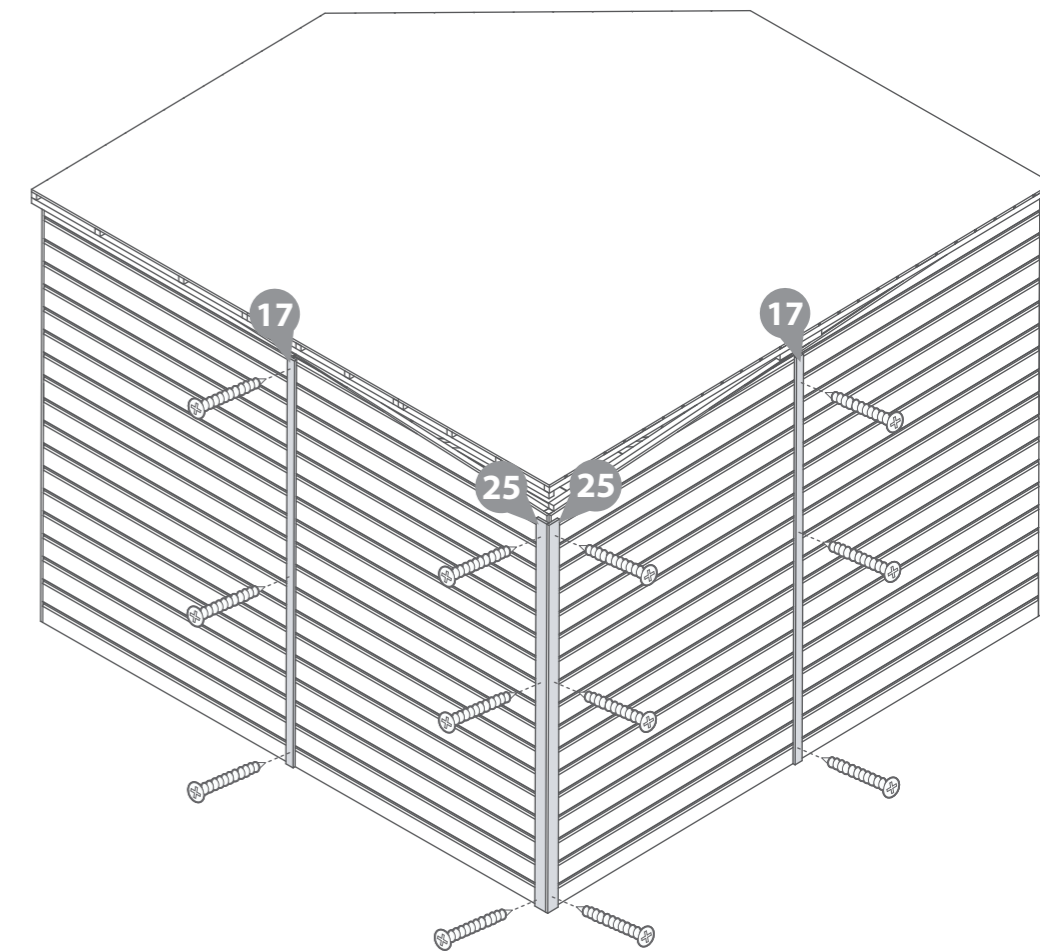

IMPORTANT: Pre-drill before fixing screws.

Step 20

Parts needed - No. 20 QTY 4
 No. 21 QTY 2
 No. 22 QTY 1

Fit the fascias (No.20, 21 & 22) to the building over the felt and secure in place with 3x40mm screws per cover trim.

Make sure the fascias at the back of the building fit lower than the roof height to allow water to run off.

21x40mm Screws

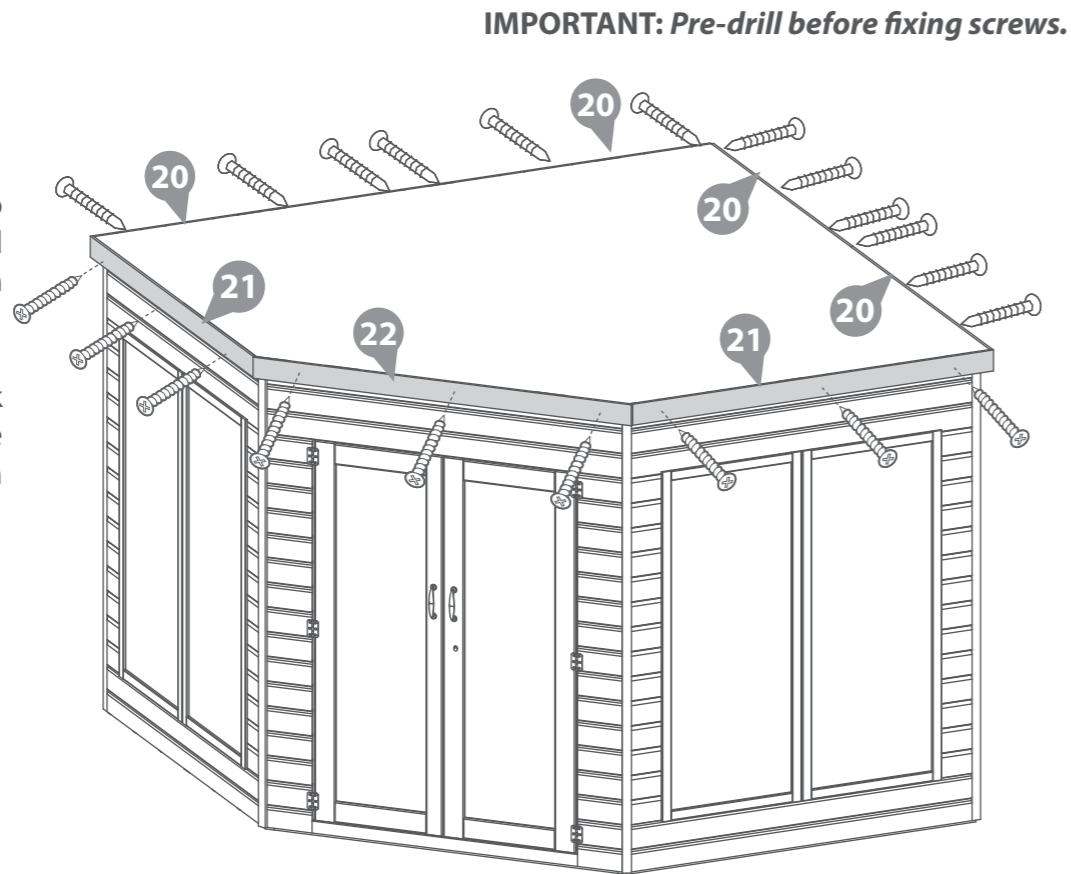
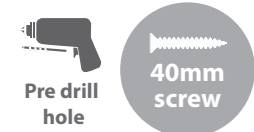

Step 21

Parts Needed - No.28 QTY 3

Fix the rain guards (No.28) above the door and both sets of windows, securing in place using 3x50mm screws per guard, ensuring to screw through the framing.

9x50mm Screws

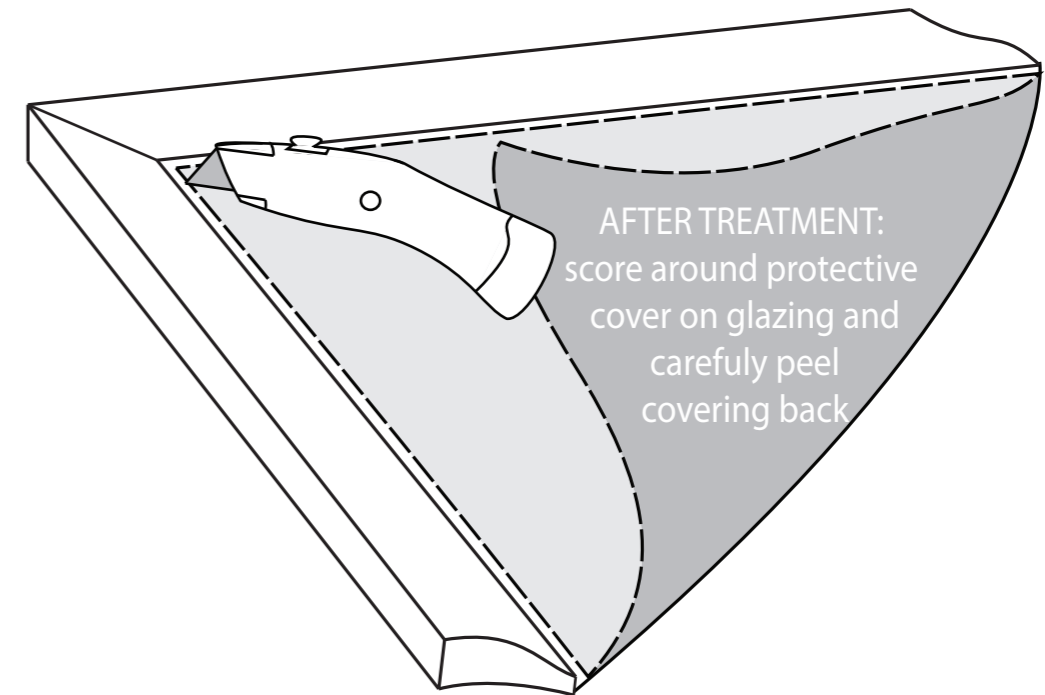
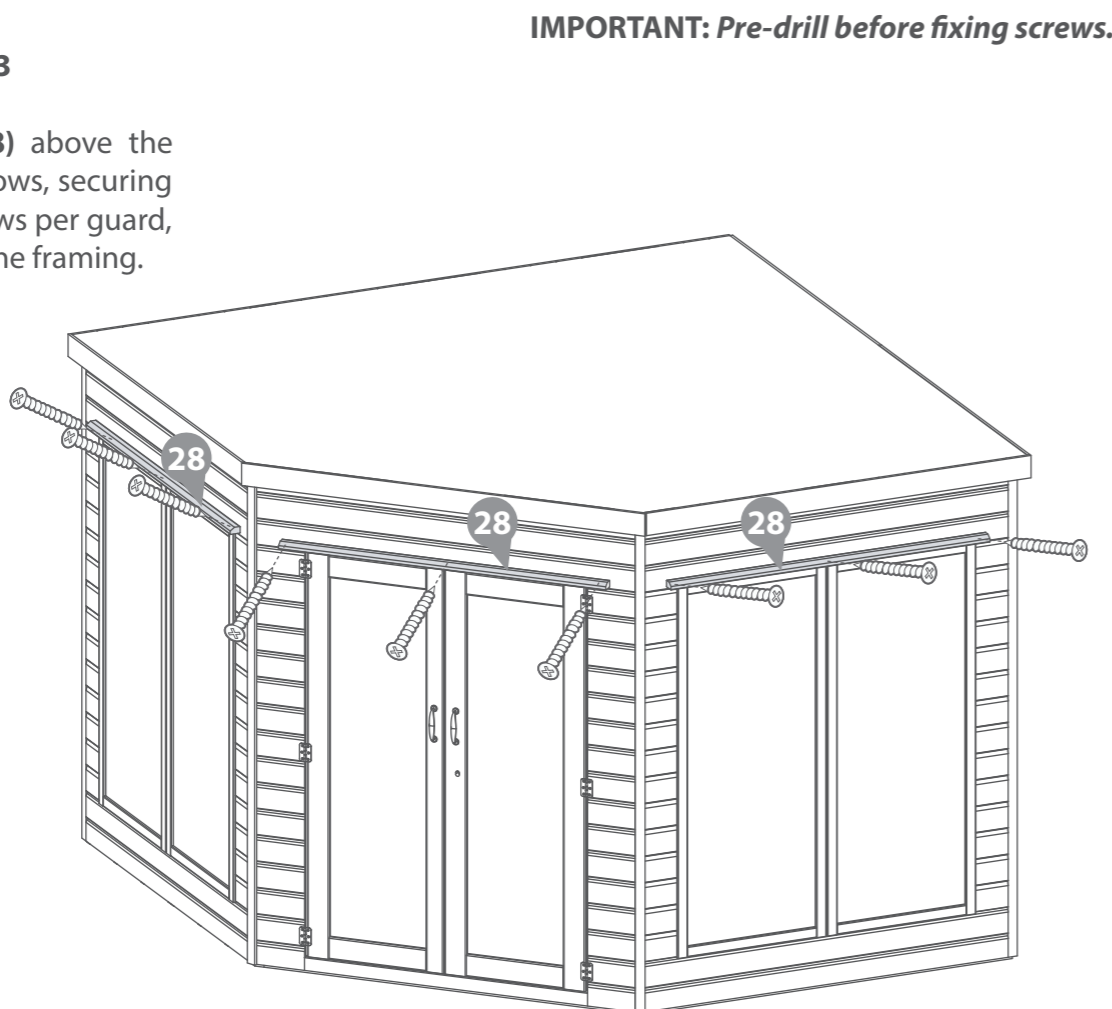
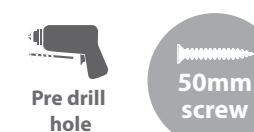

LEAVE US A REVIEW...

Want to share your experience with us?
 Leave us a review on Feefo, TrustPilot or Google.

Your reviews help other people find and trust our business, as well as helping to play an important role in our growth and improvement!

TREATING YOUR GARDEN BUILDING

Preservation of wood that's outdoors is vital. A little early care will help protect your garden building, improve its appearance and ensure maximum longevity. Insects, moisture, salt, and changing weather can have dramatic effects on the stability and appearance of your garden building. Once your building is installed, you've checked it over and you're happy with it, you can take a few basic precautions to prepare it for the elements. Treating your garden building helps prevent decay and, by repelling water, discourages the growth of moulds and fungi that could jeopardise the structural integrity of the wood.

Dip Treated buildings - Require a preservative treatment to protect against rot and decay and a waterproof treatment to prevent water ingress
Pressure Treated buildings - Require a waterproof treatment to prevent water ingress
Log Cabins/Insulated Garden Rooms - Are supplied untreated and require a preservative and waterproofing treatment.



ANY QUESTIONS?
Scan the QR code to contact us via our customer portal.

To apply a preservative and water proofing treatment (pressure treated products do not require a preserver), follow the manufacturer's instructions but in principle, stick to the following steps:

- ✓ Wear latex or rubber gloves, eye protection and (if spraying) a mask.
- ✓ Prepare the wood, by sanding down any ridges or inconsistencies in the wood, smoothing out knots and end-cuts.
- ✓ Choose a dry day to treat your garden building. If you're spraying rather than brushing paint on, avoid a windy day.
- ✓ Be sure you can safely reach all the sections you need to paint - and if you need a ladder, make sure it's safely positioned before climbing. Lay dust sheets around to avoid paint splatters on your base or surrounding plants.
- ✓ Tape around windowpanes to avoid smears when you're painting the frames.
- ✓ Keep pets and small children out of the way. The last thing you want is to have fur on your garden building paint, or little painted footprints all over your garden and home.
- ✓ Fill any gaps in the building's body with caulk or wood filler to prevent water and draughts getting in. Silicone based caulk is flexible and will move with the timber when temperature and humidity change. Allow to dry completely before treating. A handy tip for finding gaps is to go into your garden building and look for light leaking through joins and frames. If light gets in, then so will water.
- ✓ Liberally apply at least two coats of the treatment products with a brush or spray, taking care to allow the first coat to completely dry before applying the second.
- ✓ Make sure the solution permeates the whole of the surface area, especially around natural cracks, end cuts and nail/screw holes.



APPLY WOOD TREATMENT
IMMEDIATELY
AFTER ASSEMBLY

PLEASE SCAN HERE TO
SEE TREATMENT VIDEO:



1 Perimeter

Check around the perimeter of your product to ensure there are not trees or plants that are in contact with or overhanging the building. This can affect airflow and overhanging trees, or branches can damage the roof, it is advised to keep plants at a distance.

2 Repair

Inspect the interior and exterior of the product to look for splits, cracks, and holes. Although this is a natural occurrence it can be prevented. A wood filler can be used to close the splits, cracks, and holes.

3 Roof

Check your roof regularly for tears, splits, damaged wood and fallen debris. If you notice any of this immediate repair is critical.

4 Doors & Windows

Expansion and contraction can cause doors and windows to stick or become difficult to open. Small adjustments to the hinge position can be made to the doors and windows to allow free movement.

5 Oil

Hinges can seize up over time, apply lubricant to the hinges and locks annually.

6 Screws & Bolts

It is advised to check all screws and bolts and tighten any loose you might find. For log cabins specifically the storm braces will require loosening. During humidity and temperature changes (seasons) to allow expansion and contraction to prevent gaping, twisting, popping, and warping.

7 Wash

At least once a year, give the outside of your building a good wash, to remove cobwebs, leaves, or any other dirt that may accumulate on the exterior.

8 Airing

Airing your product regularly prevents the build up of condensation which can cause the timber to rot and mould. Condensation can build up over time or daily, it is caused by a rise and fall in temperature. Leaving doors and windows open regularly can help combat the natural moisture build up.

9 Clean & Tidy

It is good practice to clean the inside and outside of your product regularly. Clear out the contents, sweep the floor, remove dirt and cobwebs. Check for areas of damp and investigate the cause to remove and prevent future occurrences. Check the ground around your product for build up of debris such as leaves, remove and ensure there is clear ventilation underneath the floor.

Additional Playhouse Maintenance:

It is recommended that the following checks and maintenance are carried out at the beginning of each season as well as at regular intervals during the usage season.

- Check all nuts /bolts/ screws for tightness and tighten when required.
- Check for movement / opening of wood giving rise to protrusion of nail heads and tips.
- Check hinges.
- Replace defective parts in accordance with the manufacturers instructions.
- Check any crossbeams, suspensions and anchors.
- If a swing is included; check the swing seat, chains and ropes.

IF THESE CHECKS ARE NOT CARRIED OUT THE ACTIVITY TOY COULD BECOME A HAZARD

All our garden buildings have been designed and manufactured with care and attention to be the perfect addition to your outdoor space. To ensure you do get the best out of your new garden building and to increase the longevity we advise that you follow the product instructions and our manufacturer's recommendations as detailed below. Thank you for choosing a Mercia Garden product!

1 Choosing the most suitable location for your garden building...

A minimum of 60cm should be left around the perimeter of your garden building to allow access for maintenance, annual treatment and to allow air flow around the building.

Where possible you should avoid placing your garden building underneath large trees to prevent the tree causing damage to the building.

2 Preparing the base for your garden building...

All our buildings must be built on a firm, level base to ensure the longevity of the building and prevent the wood from distorting. We recommend either concrete, concrete slabs or a wooden base, such as our 'Portabase'.

The base should be slightly smaller than the external measurement of the building, i.e. the cladding should overlap the base, creating a run off for water and preventing water from pooling underneath the building.

We also recommend that the floor of the garden building is a minimum of 25mm above the surrounding ground level to avoid flooding.

3 After installation...

Once your garden building has been installed, it will need to be treated within 14 days (weather permitting) and annually to prevent the timber from deteriorating and to waterproof it. This is required to maintain the anti-rot guarantee.

Dip Treated buildings - Require a preservative treatment to protect against rot and decay

and a waterproof treatment to prevent water ingress.

Pressure Treated buildings - Require a waterproof treatment to prevent water ingress.

Log Cabins/Insulated Garden Rooms - Are supplied untreated and require a preservative and waterproofing treatment.

We also recommend using a silicon sealant on the inside and outside of the windows as soon as possible after assembly and treatment to fully seal the windows.

Roofing felt/covering should be checked annually and replaced or fixed accordingly.

4 General maintenance and wood characteristics

As wood is a natural material it may be affected by the following:

Shrinkage and warping - The timber used in the construction of your garden building will have retained some of its natural moisture content. The moisture content of the timber will vary, depending upon prevailing environmental conditions, which will result in the components either naturally expanding or contracting. As the components dry out, shrinkage may occur. A good waterproofing treatment from the start is the best protection to minimise the effect of moisture loss/intake.

In extended periods of very warm weather getting some moisture to the building will help the overall balance. You can do this by spraying it down lightly with a garden hose. In contrast, after snow fall try to remove the snow as best as possible from the roof to prevent moisture intake and to remove the extra weight.

Top tip - using a garden brush will help you to reach the highest part of the building to remove snow and any debris left from bad weather.

Damp and mould - During the winter months, cold and damp conditions can result in an increased amount of moisture within your garden building, especially when used infrequently. Condensation can form on the timber and other items stored within your garden building. If left this moisture is likely to cause mould and mildew.

To prevent the build-up of moisture, we recommend leaving the door or windows of your building open from time to time, to allow the fresh air to circulate. We also advise against storing wet or damp items in your garden building as this will also increase the level of moisture in the building. If mould or mildew does start to form within your building we recommend using an anti-mould cleaner to remove it and to prevent it spreading, which if left untreated could permanently damage your garden building.

Splits, cracks and knots - You may notice small splits and cracks in some components or holes may appear where knots shrink and fall out. This will not affect the structure of your Garden building however, if you wish to fill them this can be easily done using any good quality wood filler.

Sap - is naturally occurring in wood and may appear in some boards of your garden building. If you wish to remove the sap, we advise waiting until it is dry and then using a sharp knife to carefully remove it. If the removal of the sap causes a hole in the timber, we recommend using a good quality wood filler to fill it.

For more handy hints and tips on how to care and maintain your garden building please refer to the MGP Customer Portal at www.mgplogistics.co.uk

Any further questions?

Contact our
Customer Service Team via the MGP
Customer Portal at:
www.mgplogistics.co.uk

1

Manufacturer's Warranty

All Mercia Garden Products are supplied with a 1 year warranty on all parts against manufacturing defects.

This warranty does not cover movement, warping or splitting of timber products over time.

This warranty will be voided if any of the following occur:

1. The building has been customised or modified/adapted in any way.
2. The person claiming is not the original purchaser of the building.
3. Any damage has been caused by or as a result of misuse.
4. The building has not been maintained and cared for in accordance to our advisories and manufacturer's recommendations.
5. The building has not been treated annually or as per the manufacturer's recommendations, please ensure receipts are kept to validate this claim.
6. The building has not been erected, fitted or installed as per the supplier instructions.
7. The building has not been erected on a suitable sized firm flat, solid level concrete/slab base or placed on pressure treated bearers.
8. The building is or has been placed with 2 feet (600mm) of any obstructions (walls, trees, plants, fences etc.) which can allow moisture to penetrate the timber.
9. The roofing felt has been incorrectly fitted or damaged, allowing water ingress, or has not been properly maintained.
10. Any windows and joints have not been sealed, inside and out, with silicone or other watertight sealant.
11. Any timber has been cut, pierced or drilled without subsequent application of approved cut-end treatment.

2

Anti-rot Guarantee

Mercia Garden Products offer a 10 year anti-rot guarantee on all dip treated (a preparatory treatment) and 15 years on all pressure treated products. This guarantee covers solid timber against rot, decay, blue stain and insect attacks.

To validate the guarantee, the building must be treated (as detailed within manufacturer's recommendations) within 14 days (weather permitting) of assembly and annually thereafter.

This guarantee does not cover movement, warping or splitting of timber products over time.

This guarantee will be voided if any of the following occur:

1. The building has been customised or modified/adapted in any way.
2. The person claiming is not the original purchaser of the building.
3. Any damage is caused by or as a result of misuse.
4. The building has not been maintained and cared for in accordance to our advisories and manufacturer's recommendations.
5. The building has not been treated annually or as per the manufacturer's recommendations, please ensure receipts are kept to validate this claim.
6. The building has not been erected, fitted or installed as per the supplier instructions.
7. The building has not been erected on a suitable sized firm flat, solid level concrete/slab base or placed on pressure treated bearers.
8. The building is or has been placed with 600mm of any obstructions (walls, trees, plants, fences etc.) which can allow moisture to penetrate the timber.
9. The roofing felt has been incorrectly fitted or damaged allowing water ingress, or has not been properly maintained.
10. Any windows and joints have not been sealed, inside and out, with silicone or other watertight sealant.
11. Any timber has been cut, pierced or drilled without subsequent application of approved cut-end treatment.



REGISTER FOR YOUR
ANTI-ROT
GUARANTEE TODAY

PLEASE SCAN HERE:

