

## PLEASE READ THE INSTRUCTIONS CAREFULLY

- Check the pack and make sure you have all the items listed in the parts list provided.
- When you are ready to start, make sure you have the right tools at hand (not supplied - see the equipment list below).
- Ensure there is plenty of space and a clean dry area for assembly.
- Ensure you have enough time to fit the glazing into the entire building. This will ensure no damage is caused.

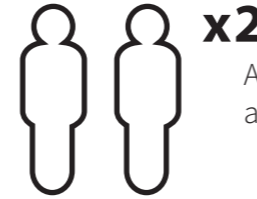

x2

All glazing should be fitted by two adults.

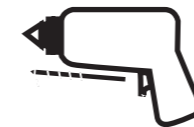

2mm Drill bit

For ease of assembly, you **MUST** pilot drill all screw holes and ensure all screw heads are countersunk.



For ease of assembly, you will need a tape measure to check dimensions of components and fixings.



Winter = High Moisture = Expansion  
Summer = Low Moisture = Contraction



## CAUTION

Every effort has been made during the manufacturing process to eliminate the prospect of splinters on rough surfaces of the timber. You are strongly advised to wear gloves when working with or handling rough sawn timber.

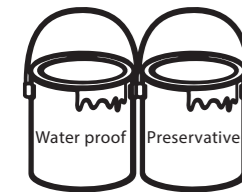

## TREATMENT

Before beginning to fit your glazing, ensure your garden building and loose components have been fully treated with a preservative treatment to protect against rot and decay and a waterproof treatment to prevent water ingress.

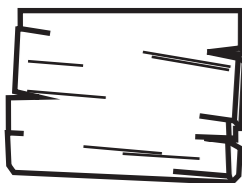

## TIMBER

As with all natural materials, timber can be affected during various weather conditions. For the duration of heavy or extended periods of rain, swelling of the wood panels may occur. Warping of the wood may also occur during excessive dry spells due to an interior moisture loss. Unfortunately, these processes cannot be avoided but can be helped. It is suggested that the outdoor building is sprayed with water during extended periods of warm sunshine and sheltered as much as possible during rain or snow.

## Screws & Nails

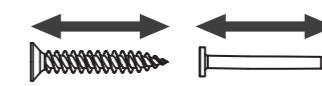

Measure overall length

## Bolts

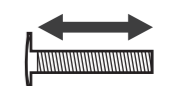

Measure under the head

## \*\*Protim Aquatan T5 (621)\*\*

Your timber components have been dip treated with Aquatan. Aquatan is a water-based concentrate which is diluted with water, the components have been treated by the correct application of Aquatan solution and then allowed to dry.

Aquatan is a decorative finish to colour the wood, which is applied industrially to timber fence panels and garden buildings.

Aquatan undiluted contains: boric acid, sodium hydroxide 32% solution, aqueous mixture of sodium dioctyl sulphosuccinat and alcohols: 2, 4, 6-trichlorophenol.

## TO DO LIST

- Ensure your garden building has been fully treated with a preservative treatment and a waterproof treatment.
- Check you have the required equipment / tools.
- Check you have all the product items listed (if you have missing or damaged parts please scan the QR code on the right to visit our online customer portal).
- Fit the glazing into your assembled building as per the step by step instructions within this pack.
- Register for your anti rot guarantee (scan the QR on the right).
- Tidy the build area and dispose of any remaining parts responsibly.
- Maintain your building (see the manufacturers recommendations at the back of this pack).

## EQUIPMENT LIST

- |  |   |
|--|---|
| <input type="checkbox"/> Drill                         | <input type="checkbox"/> Ladders/Steps              |
| <input type="checkbox"/> Drill Bit Set                 | <input type="checkbox"/> Stanley Knife/Cutting Tool |
| <input type="checkbox"/> Phillips and Slotted Bit Sets | <input type="checkbox"/> Gloves                     |
| <input type="checkbox"/> Tape Measure                  | <input type="checkbox"/> Clear Silicone             |
| <input type="checkbox"/> Hand Saw                      | <input type="checkbox"/> Sealant Application Gun    |

Whilst all products manufactured are made to the highest standards of safety and in the case of children's products independently tested to EN71 level, we cannot accept responsibility for your safety whilst erecting or using this product.

REGISTER FOR YOUR  
**15 YEAR**  
ANTI-ROT  
GUARANTEE TODAY



[www.mgplogistics.co.uk](http://www.mgplogistics.co.uk)

In all instances for assistance with your product or to register your anti rot guarantee, please contact us via our customer portal

Mercia Garden Products Limited,  
Sutton On Trent, Newark,  
Nottinghamshire, NG23 6QN

## NEED EXTRA SUPPORT

If you are unsure that your building preparation will be suitable, please contact us via our customer portal to discuss this further.

Alternatively, you can visit our website or MGP Logistics Online Portal for some further sheducation.

### Website:

<https://www.merciagardenproducts.co.uk/sheducation>

### MGP Logistics Online Portal:

<https://www.mgplogistics.co.uk/>

Here you will find plenty of useful information that'll help with most pre-installation and maintenance queries.



## ANY QUESTIONS?

Scan the QR code to contact us via our customer portal.



## ACCESSING VIDEO GUIDES...

Some steps within this set of instructions come with an added video guide for your convenience. These can be accessed via the QR code and used to aid you in constructing that step. See below for how to use.

You can also find all the videos on our youtube channel:  
<https://www.youtube.com/@merciagardenproducts8716/videos>

### 1. Find the QR code within the instruction step...

#### Step.....

Parts Needed- No. QTY 1  
No. QTY 1  
No. QTY 1

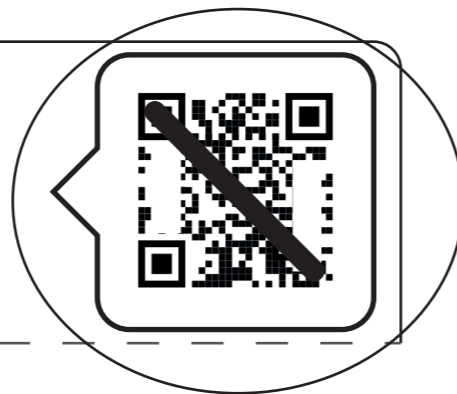

Within the instruction step, there will be an icon in the top right that has a QR code in. This is where the video can be accessed from.

*Please note: not every step has a video guide.*

### 2. Open camera app...

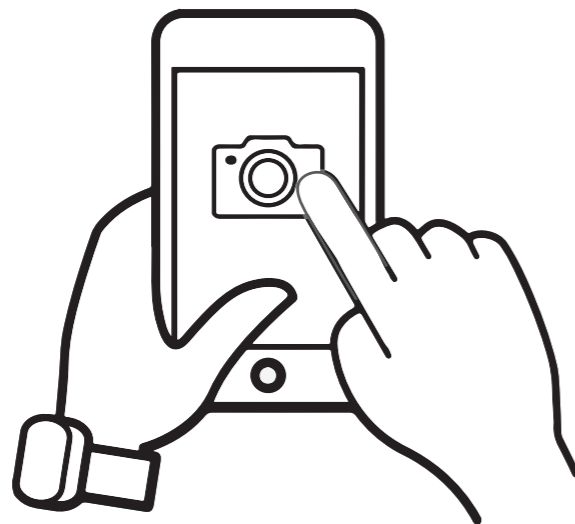

On your personal smart device (phone, tablet etc), open your camera app or QR code scanner app.

## ACCESSING VIDEO GUIDES...

### 3. Scan QR code...



To scan the QR code, hold the camera over the QR code so that it can be seen on the screen. Once the QR code has been registered, follow the prompts on your device to open the video. (This will vary depending on your device.)

*Please note: Ensure to use the back camera of your smart device as this will scan the QR code more accurately.*

### 4. Watch the video...

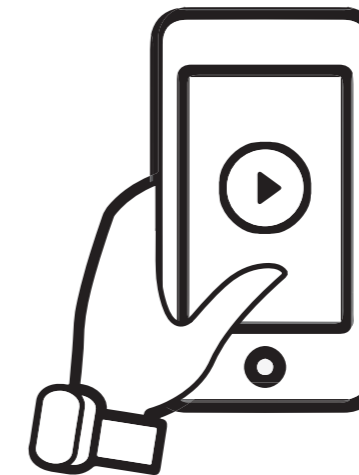

The video guide will now be displayed on your smart device.

**Disclaimer:** The garden building constructed in the video guides may be constructed differently to your building. Please ensure to read your instructions carefully to avoid error.

### Glazing Manual Contents:

'What building do I have' guide - Page 3

6ft Apex Building Contents - Page 4

4ft Pent Building Contents - Page 5

Glazing Sheet Guide - Page 6

Pre-Assembly - Page 7

Polycarbonate Sheet Prep - Page 8

Roof Panel Glazing - Page 9

Wall Panel Glazing - Page 10

After Treatment - Page 11

### What building do I have?

All of our modular Greenhouses have different names and different components, so it's important to understand what building you have and what comes with it before beginning assembly. Please refer to the information below to check what type of building you have before beginning construction.

This instruction manual contains generic steps to fit the Polycarbonate glazing into all our greenhouses. Your building will be one of the types listed below:

- 6ft Apex Greenhouse
- 6ft Apex Combi
- 4ft Pent Greenhouse
- 4ft Pent Combi

You will have purchased one of these buildings and have the components to fit the polycarbonate glazing into only that.

***All of the Greenhouses in this manual are either 4ft or 6ft wide, with differing depths. In the same way you have done to construct your main building, throughout the instructions, ensure to check that you are referring to the correct building where necessary.***

*If you are still unsure what building you are glazing, please refer to your main building instruction manual to clarify.*

### What type of glazing do I have?

This instruction manual shows steps to fit **POLYCARBONATE** glazing into all of your required panels.

Polycarbonate is a type of plastic that can be formed into a layered sheet.

To check you have the correct type of glazing, measure the thickness of the glazing sheets and observe the finish of the sheet. Polycarbonate should be 4mm thick with visible lines of hollow flutes within the sheet.

### 6ft Apex Building Glazing Contents:

In the table to follow, please refer to the row with your chosen building size in to determine how many of each part is required.

Tip: Labelling your parts, using a pencil and masking tape, may help you to identify them easier when you need them.



1

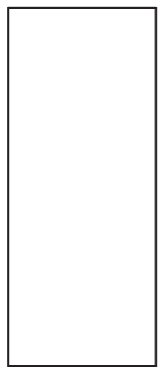

**Wall Glazing**  
522x1265mm  
PI-05-0252

2a



**Apex Roof Glazing**  
528x928mm  
PI-05-0254

2b



**Apex Roof Glazing**  
528x300mm  
PI-05-0255

3

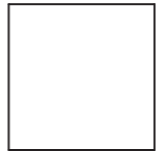

**Sash Window Glazing**  
528x503mm  
PI-05-0256

4

End View



**Beading Strip\*\***  
12x17x1500mm  
S1217-1500mm

5

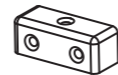

**Glazing Blocks**  
PI-07-0011

6



**Solid Tape\*\***  
PI-05-0264

7



**Ventilation Tape\*\***  
PI-05-0265

8

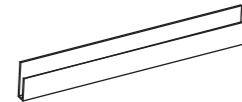

**Edge Protector**  
496mm  
PI-05-0266



**30mm Screw**

Greenhouse Model	1	2a	2b	3	4	5	6	7	8	Screw
<b>4 X 6 APEX GREENHOUSE</b> SI-100-004-0002	QTY 9	QTY 3	QTY 1	QTY 1	QTY 24*	QTY 10	QTY 10 METERS	QTY 10 METERS	QTY 14	QTY 74
<b>6 X 6 APEX GREENHOUSE</b> SI-100-004-0010	QTY 11	QTY 5	QTY 1	QTY 1	QTY 24*	QTY 14	QTY 12 METERS	QTY 12 METERS	QTY 18	QTY 94
<b>8 X 6 APEX GREENHOUSE</b> SI-100-004-0018	QTY 13	QTY 7	QTY 1	QTY 1	QTY 32*	QTY 18	QTY 14 METERS	QTY 14 METERS	QTY 22	QTY 114









\*You may have more of this part that required.

\*\*This part will be longer than needed and requires cutting to size when used. This will be explained when required within the instruction step.

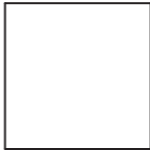
### 4ft Pent Building Glazing Contents:

In the table to follow, please refer to the row with your chosen building size in to determine how many of each part is required.

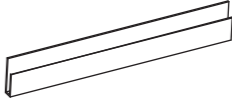
Tip: Labelling your parts, using a pencil and masking tape, may help you to identify them easier when you need them. *NO.1 FLOOR PANEL*

	<b>1</b>	<b>2c</b>	<b>3</b>	<b>4</b>	<b>5</b>	<b>6</b>	<b>7</b>	<b>8</b>	
									
	<b>Wall Glazing</b> 522x1265mm <i>PI-05-0252</i>	<b>Pent Roof Glazing</b> 528x1130mm <i>PI-05-0257</i>	<b>Roof / Window Glazing</b> 528x503mm <i>PI-05-0256</i>	<b>Beading Strip**</b> 12x17x1500mm <i>S1217-1500mm</i>	<b>Glazing Blocks</b> <i>PI-07-0011</i>	<b>Solid Tape**</b> <i>PI-05-0264</i>	<b>Ventilation Tape**</b> <i>PI-05-0265</i>	<b>Edge Protector</b> 496mm <i>PI-05-0266</i>	<b>30mm Screw</b>
<b>8 X 4 LEAN-TO GREENHOUSE</b> <i>SI-100-004-0026</i>	<b>QTY 7</b>	<b>QTY 3</b>	<b>QTY 2</b>	<b>QTY 16*</b>	<b>QTY 10</b>	<b>QTY 8 METERS</b>	<b>QTY 8 METERS</b>	<b>QTY 12</b>	<b>QTY 62</b>



### Missing parts?

Scan the QR code to visit our customer portal where you can quickly raise any missing or damaged parts and get a replacement sent out ASAP.



\*You may have more of this part that required.

\*\*This part will be longer than needed and requires cutting to size when used. This will be explained when required within the instruction step.

### Glazing Sheet guide:

The method of glazing your Roof Panels/sash windows and Wall Panels is the same, regardless of building size. Please refer to the guide below to ensure you pair the correct glazing size with the correct panel.

#### Wall Panels

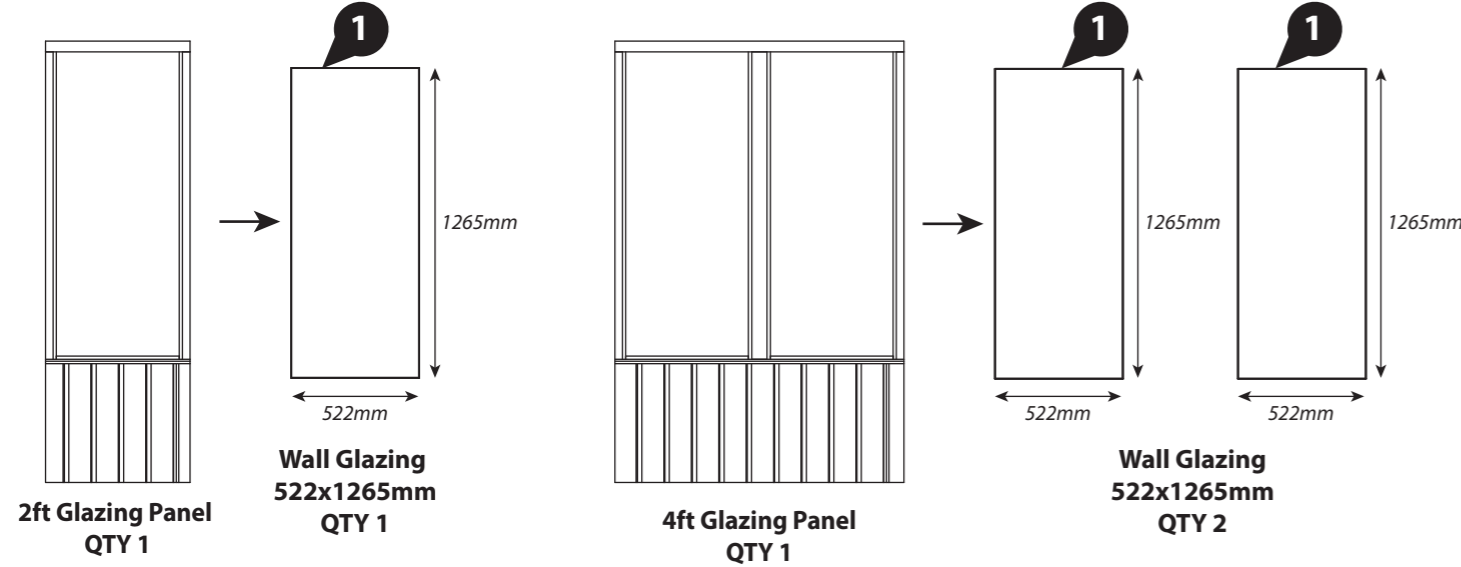

#### Window

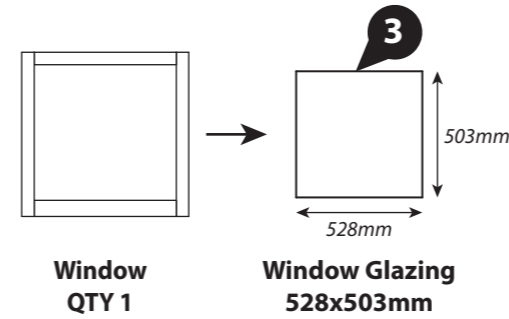

**\*IMPORTANT\***  
 Ensure to measure each of your glazing sheets before fitting them into the panels to ensure you fit them the correct way around.

**What type of glazing do I have?**  
 This instruction manual shows steps to fit **POLYCARBONATE** glazing into all of your required panels.

#### 6ft Apex Roofs

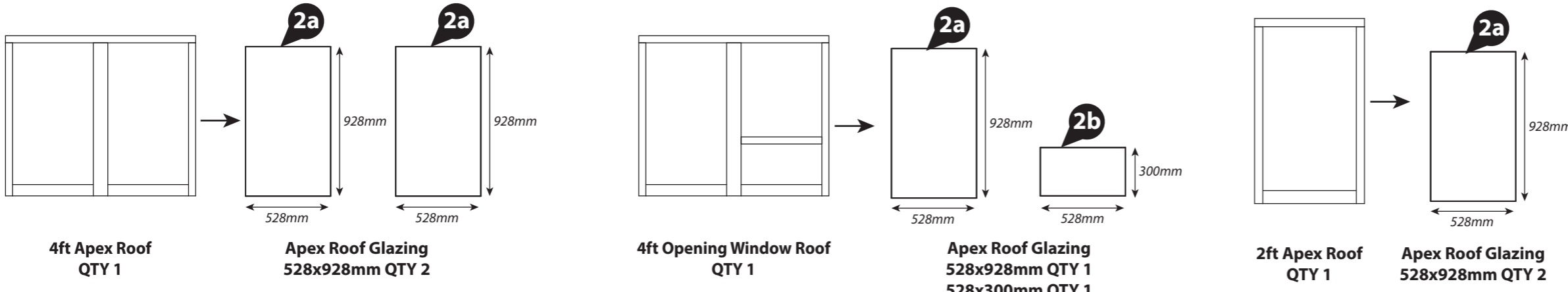

#### 4ft Pent Roofs

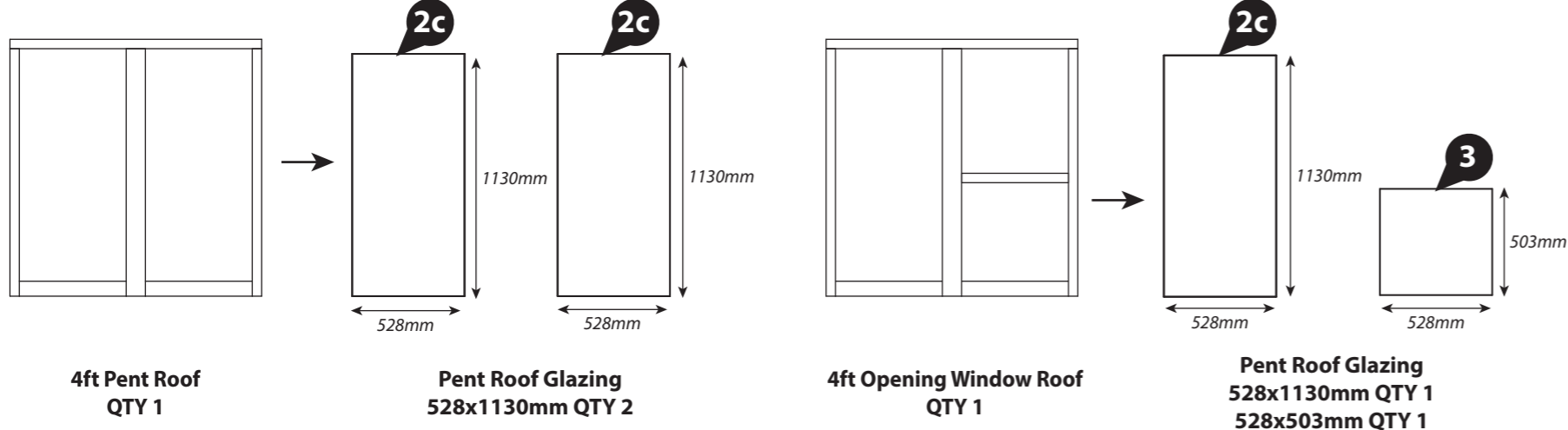

## Pre-Assembly

- a** Before glazing your panels, ensure your assembled building is fully treated.
- b** Each sheet of glazing will have a plain blue film on one side. The other side will have clear film with printed text on.

**The clear side with printed text on is the side that is UV protected, and must be facing outwards when fitted into your building.**

**It is vital that you make note of which side is which BEFORE removing the film.**

- c** To remove the films, find a loose corner and gently peel the covers back.

If you cannot find a loose corner, use a knife or scraping tool to gently persuade the corner to lift and then gently peel back.

**\*TIP\***

Remove one side of film at a time, starting with the clear printed text side. Once removed mark this side as 'UV protected' using a pencil and masking tape, ensuring not to damage the flutes.

*Each sheet of glazing comes with plastic film on for protection during transportation and for ease when being treated. As you have already fully treated your building, these films can be removed before fitting.*



Score and peel.

**\*IMPORTANT\***

Continue to treat your building annually after completing construction. To avoid getting treatment on the glazing, apply tape around the edge of each glazed panel and remove once fully treated.

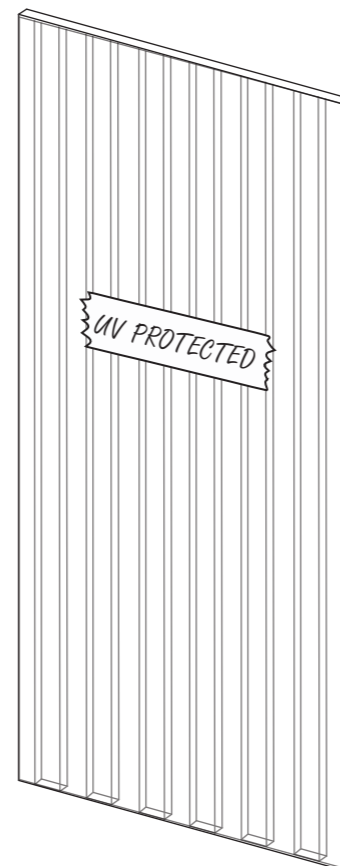
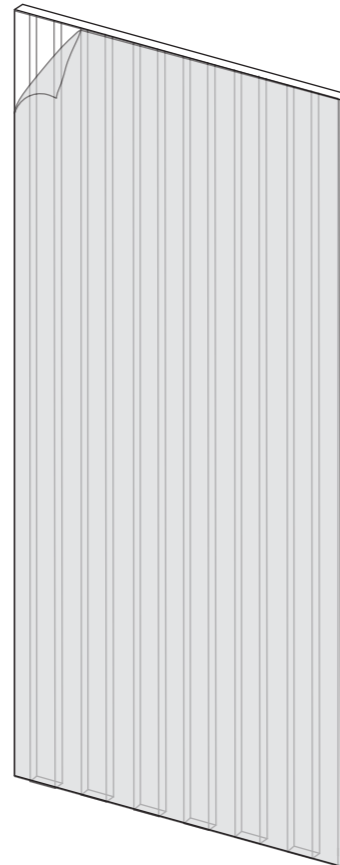

**Before glazing, please make sure you have fully assembled and treated your building.**

## Polycarbonate Sheet Prep

		Parts Needed					
<b>Building</b>		No. 1	No. 2 (a, b or c)	No. 3	No. 6	No. 7	No. 8
<b>All PC sheets</b>	<b>TOTAL QTY REQUIRED FOR BUILDING</b>						

- a** Ensure the Glazing sheets (**No. 1, 2 and/or 3**), are clean, dry, and that any dirt or moisture within the flutes has been removed.

*If you have not already done so, remove the protective film on both sides, ensuring to note which side is UV protected.*

Lay the sheet out so the UV protected side is face up. On the top end, apply the Solid Tape (**No. 6**) to one side of the sheet, leaving the end open. Ensure to leave an overhang of tape (at least 25mm) at the start. Place the tape so it can be folded over the open end to cover both sides. Do not fold the tape over yet.

Apply the tape across the whole width of the sheet, extending it at least 25mm past the end of the sheet. Once applied, trim the tape off using scissors or a safety knife.

- b** Once trimmed, fold the tape over the open end of the sheet. Gently press down on both sides to seal. At either end, carefully fold the tape so it fits around the corners.

- c** At the bottom end of the sheet, use the methods outlined in steps A & B to fit the Ventilation Tape (**No. 7**).

Ensure the cut outs along the centre of the tape align centrally with the cut outs along the end of the glazing sheet.

- d** At the end of the sheet with the Ventilation Tape on, carefully slide the Edge Protector (**No. 8**) onto the glazing sheet, ensuring not to tear or damage the tape.

Position the protector so it is central to the glazing sheet, as shown. The longer side of the protector should be positioned on the top side of the sheet, with the shorter on the underside, as shown.

**Repeat steps A-D to fit the Solid tape, Ventilation tape and Edge Protector to all glazing sheets.**

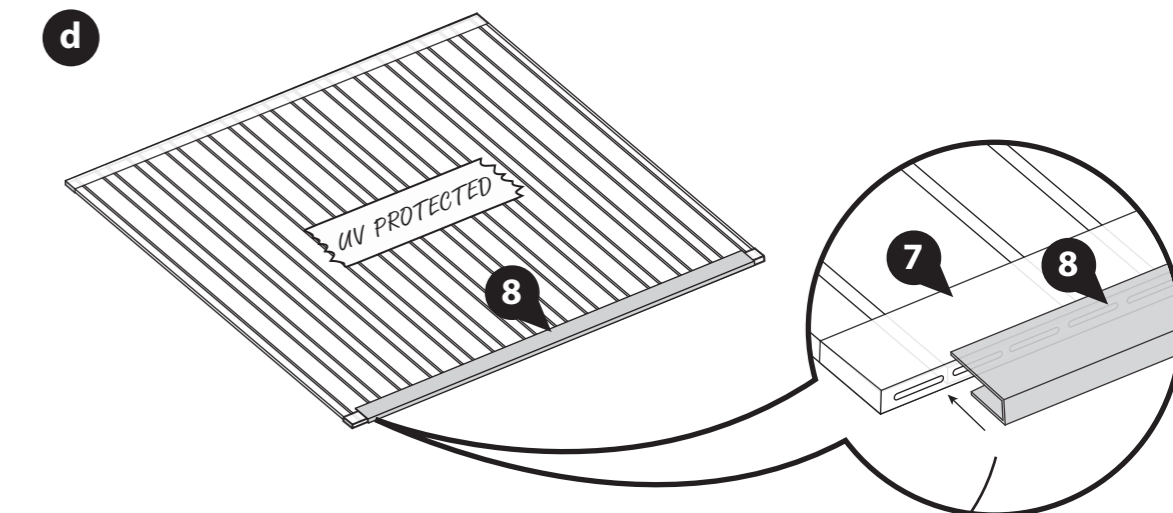
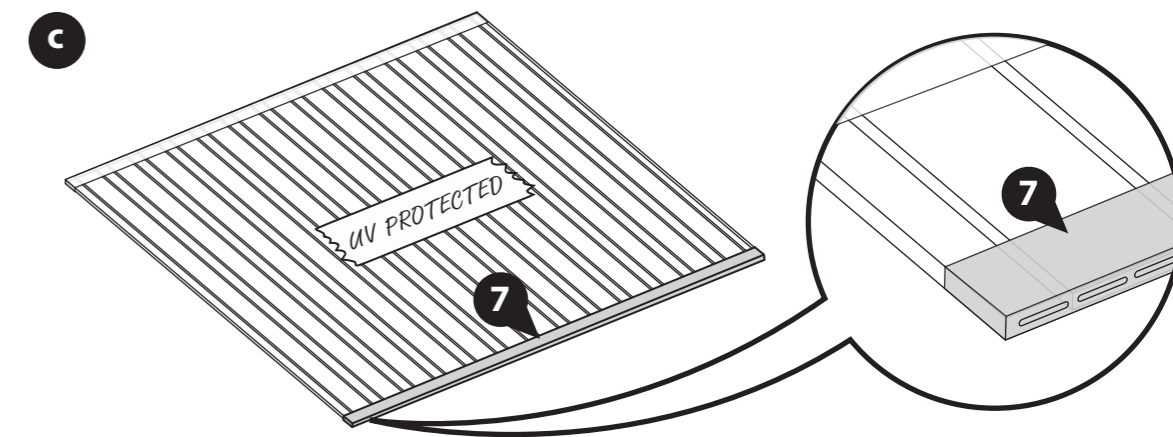
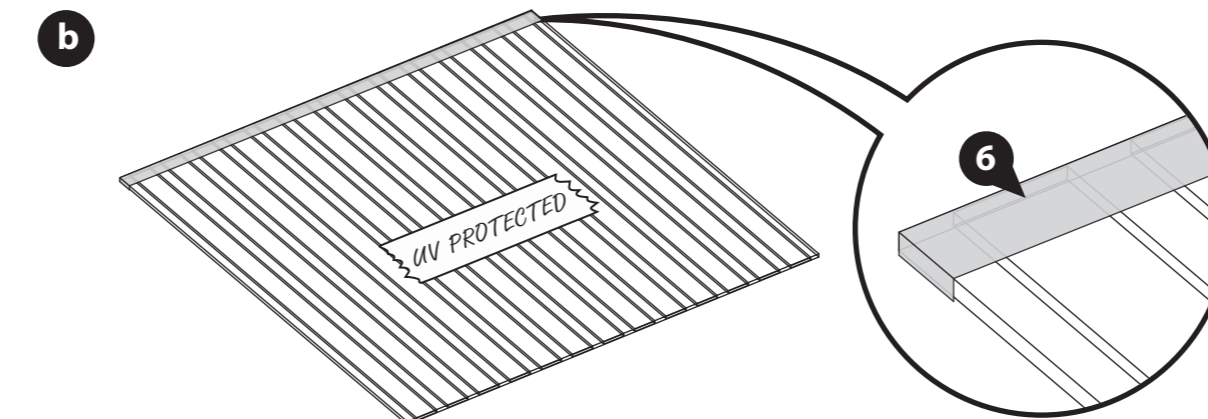
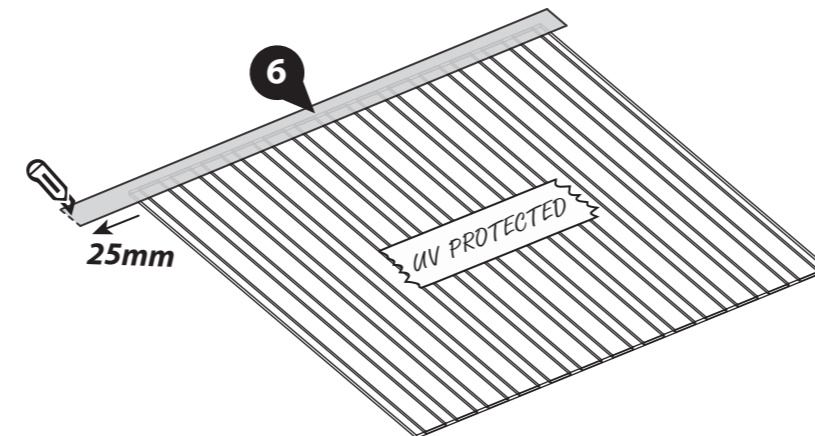
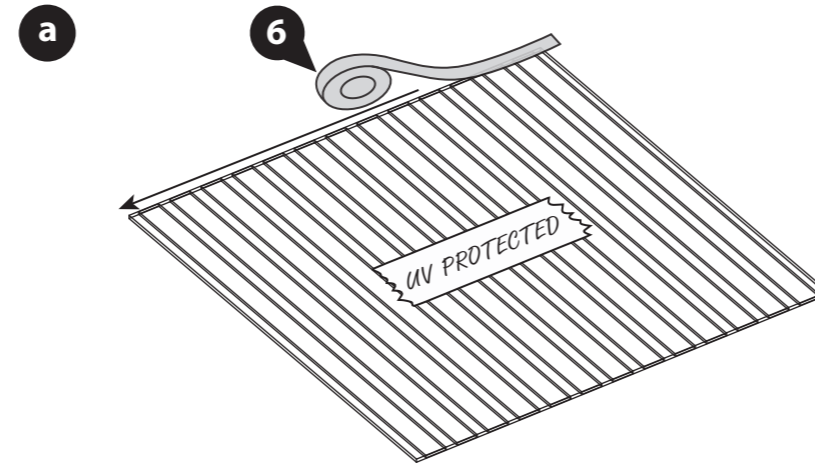

*The longer side of the protector should sit on the top of the glazing, and the shorter on the back.*

### What are the tapes and protector for?

The tapes and protector create a barrier at either end of your glazing sheet. This helps stop physical debris - such as dust or insects - getting inside your glazing.



**All Polycarbonate glazing sheets must be prepared and taped before using for assembly. If you have not yet prepared and taped your Polycarbonate glazing sheets, please refer to the previous page.**

**Before glazing, please make sure you have fully assembled and treated your building.**

## Roof Panel Glazing

Parts Needed			
<b>Building</b>	<b>No. 2 (a, b or c) and/or No.3</b>	<b>No. 5</b>	<b>30mm screws</b>
<b>1 x roof panel</b>	<b>QTY 3</b>	<b>QTY 6</b>	<b>QTY 12</b>

**\*\*Please Note: The process of fitting the glazing into the Roof Panels is the same for both Apex and Pent buildings and for Standard Roof Panels and Roof Panels with an Opening Window.**

**a** Starting from one Gable end on the first Roof Panel, slide one sheet of Roof Glazing (**No. 2 or 3**) into the Panel grooves. Push the sheet all the way into the Panel. Ensure the sheet stays within the Panel grooves and is positioned centrally across the width of the Panel, as shown. The Edge protector (**No. 8**) should sit centrally between the Panel framing.

**Make sure the Sheet is the correct way up, with the UV protected side facing outwards (face up in the panel). Ensure the Solid tape (No. 6) is at the top of the Panel, and the with the Ventilation tape (No. 7) and Edge Protector (No. 8) are at the bottom.**

**The longer side of the protector should be positioned on the top side of the Panel, with the shorter on the underside, as shown.**

The Glazing will not finish flush with the bottom of the Panel, and will sit further up, as shown.

**b** At the bottom of the Roof Panel, where the Glazing ends, position two Glazing Blocks (**No. 5**). Ensure they sit flush up to the Glazing sheet and are positioned equally along the width, as shown.

Secure each Glazing Block in place using 2x30mm screws, screwing through the Glazing Block into the framing below.

**c** Around each side of the Glazing (internally and externally), apply a neat line of Clear Silicone, as shown. This will help make sure your roof is water tight.  
\*Clear silicone not provided.

Repeat steps A-C to fit the Glazing into each opening on the Panel.

**d** Working along the building (end-to-end), repeat steps A-C to fit the Glazing sheet, Glazing Blocks and Silicone to each Roof Panel on your building.

*Please note: A 4ft Roof Panel with an Opening Window has been shown for illustrative purposes, however the process of fitting the glazing into a Standard 4ft Roof Panel or a 2ft Roof Panel is the same.*

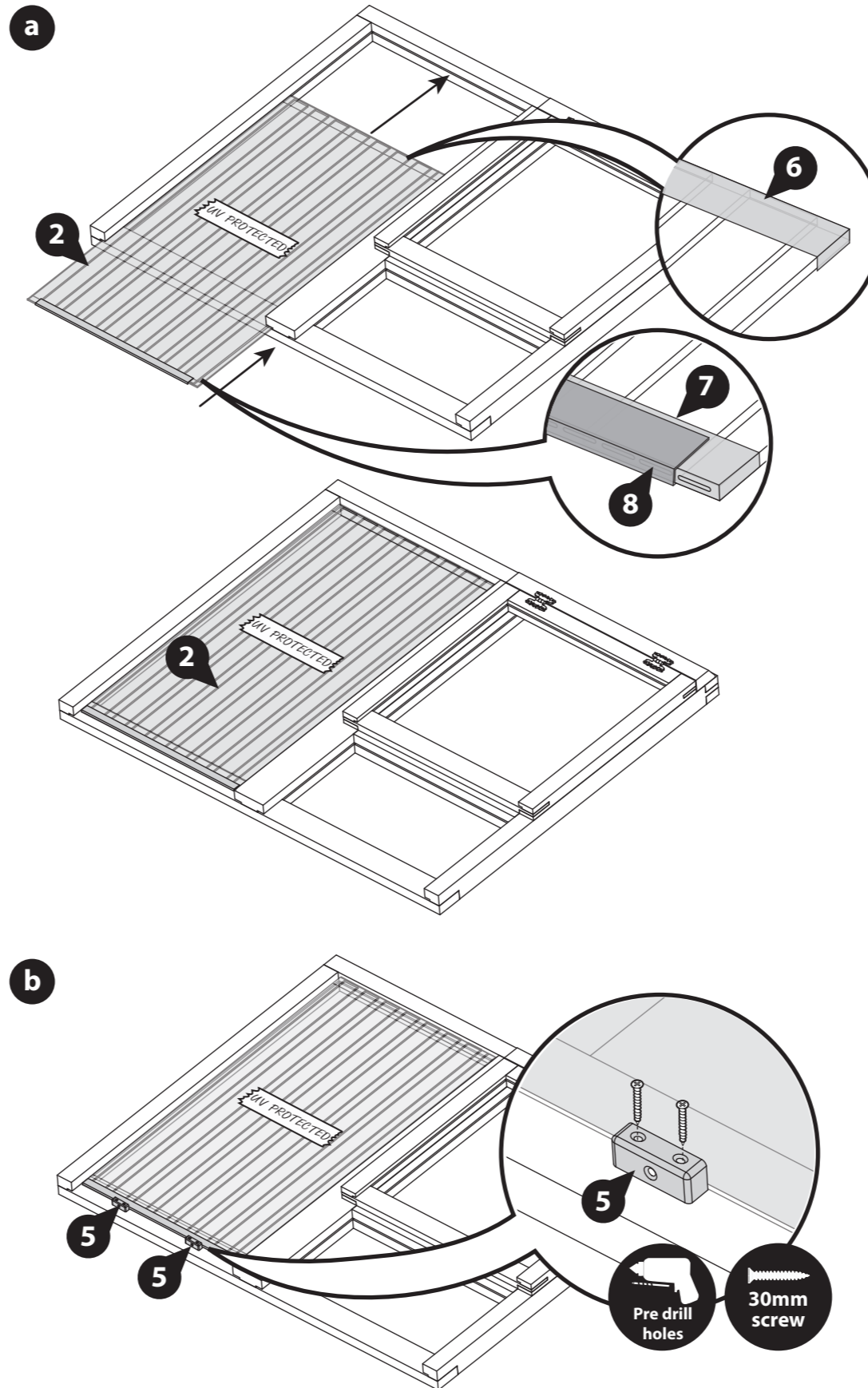

**IMPORTANT: Pre-drill before fixing screws.**

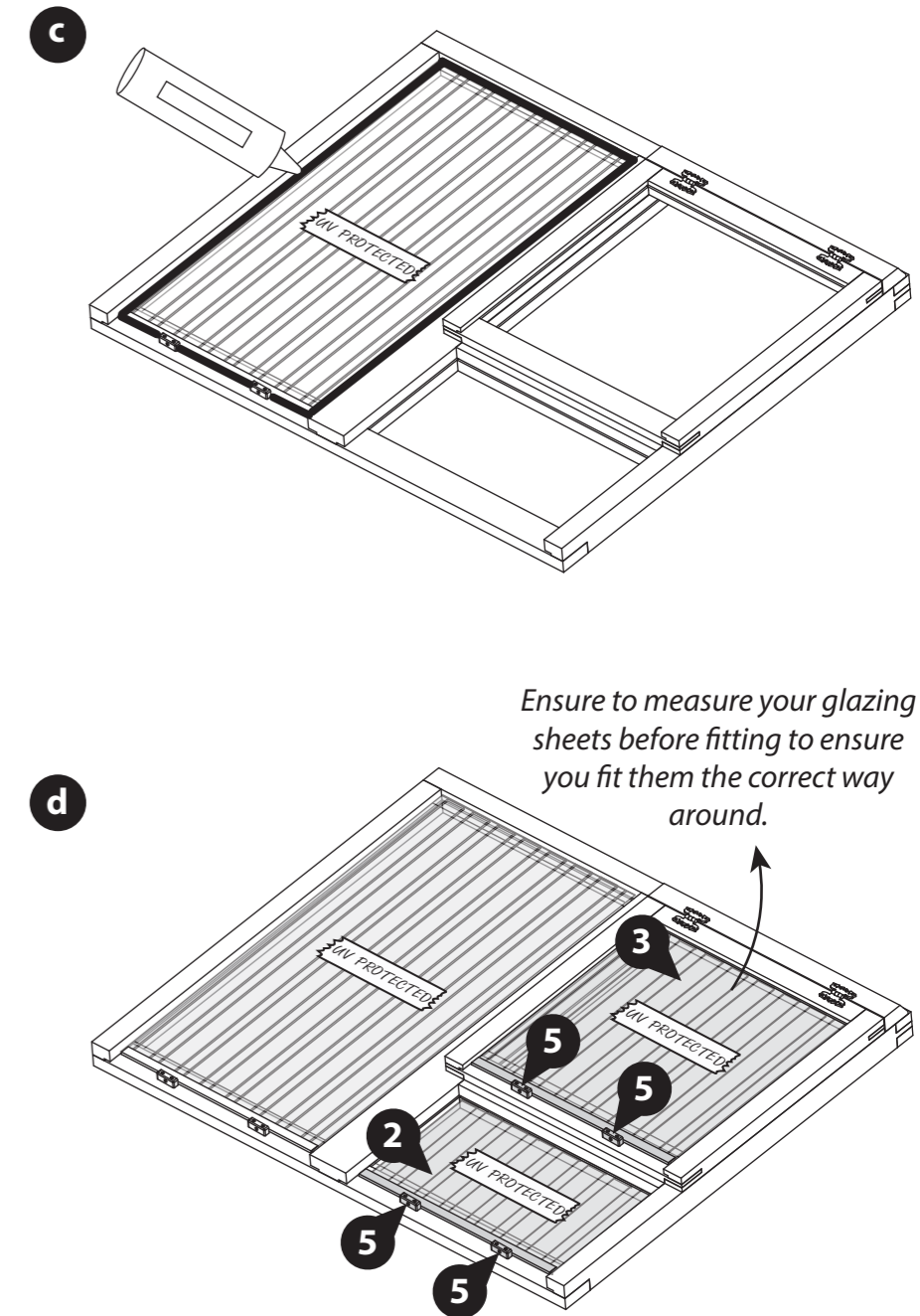

**IMPORTANT NOTE**  
When fitting the glazing into the opening window, ensure the window is latched shut.

**All Polycarbonate glazing sheets must be prepared and taped before using for assembly. If you have not yet prepared and taped your Polycarbonate glazing sheets, please refer to the previous page.**

**Before glazing, please make sure you have fully assembled and treated your building.**

**IMPORTANT: Pre-drill before fixing screws.**

## Wall Panel Glazing

### Parts Needed

Building	No. 1	No. 4	30mm screws
1 x wall panel	QTY 1	QTY 2	QTY 6

**a** On one 2ft Glazing Panel, apply a neat line of Clear Silicone around each side of the Panel framing and along the edge of the cill, as shown. *\*Clear silicone not provided.*

**b** Place one sheet of Wall Glazing (No. 1) on to the window cill, ensuring to slot it into the groove in the top framing, then position it against the upright framing. Make sure the sheet sits centrally on the Panel framing, as shown.

**Make sure the Sheet is the correct way up, with the UV protected side facing outwards. Ensure the Solid tape (No. 6) is at the top of the Panel, and the with the Ventilation tape (No. 7) and Edge Protector (No. 8) are at the bottom. The longer side of the protector should be positioned on the top side of the Panel, with the shorter on the underside, as shown.**

Gently press the sheet onto the clear silicone for a tight seal.

**c** On either side of the Glazing, use a tape measure to measure the distance from the top of the cill to the underside of the top framing, as shown.

Cut two Beading Strips (No. 4) to this size and position them flush against the glazing and the Panel framing on either side, as shown. Ensure the Beading Strips sit flat on the cill.

**\*\*The strips should NOT sit over the Edge Protector.**

Secure in place using 3x30mm screws per Beading Strip, screwing through the Beading Strip into the Panel framing, as shown.

Repeat steps A-C to apply Silicone, fit the Glazing sheet and fix the Beading Strips to each 2ft and 4ft Glazing Panel on your building.

*Please note: A 2ft Glazing panel has been shown for illustrative purposes, however the process of fitting the glazing into a 4ft Panel is the same.*

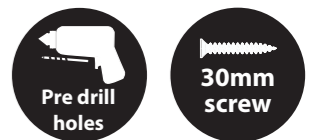
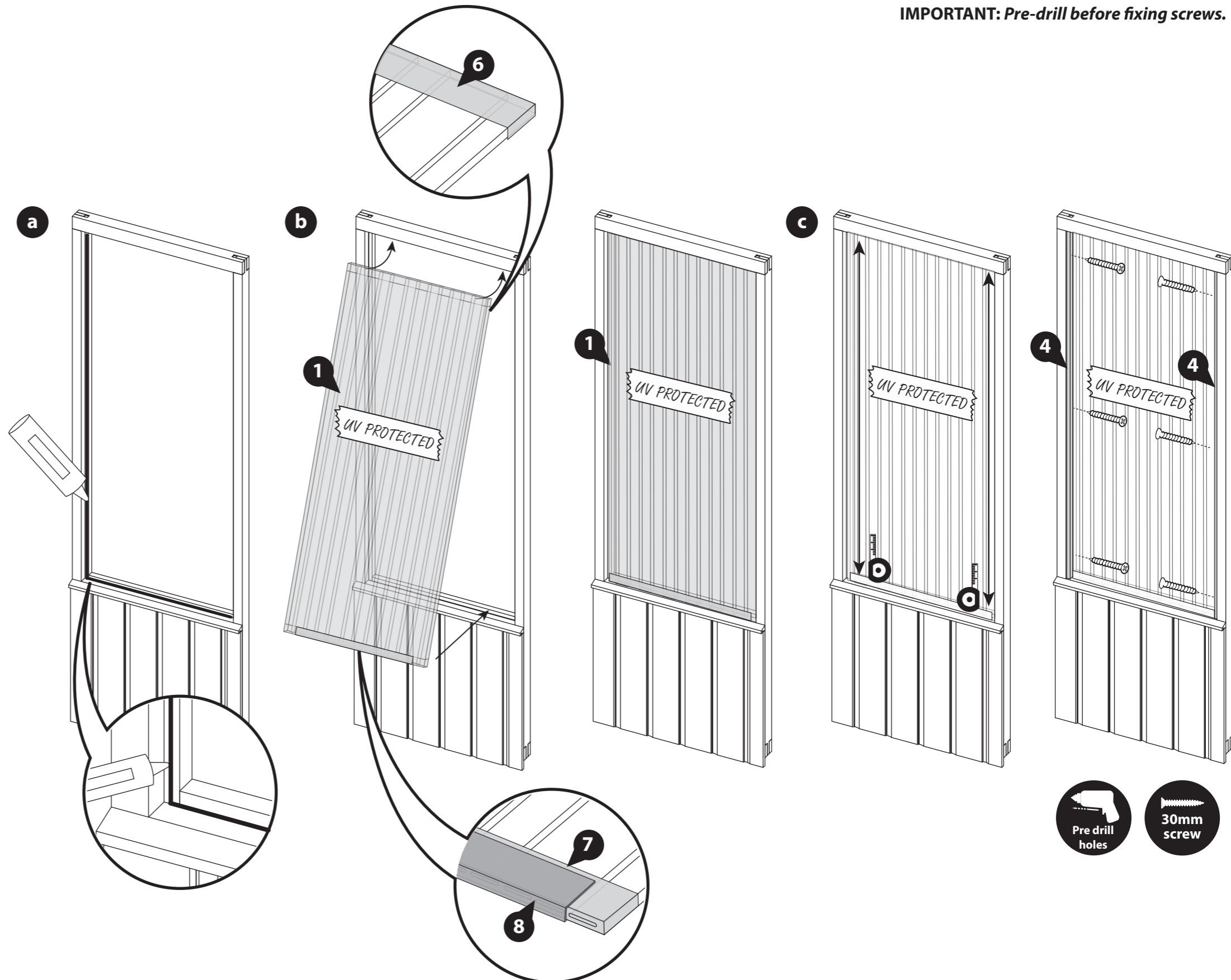

## After Treatment

Once your building is fully glazed, touch up any areas where the treatment has been removed or slightly scuffed.

**\*\*Make sure to check any Beading Strips that have been cut to size post-treatment.**

Ensure to remove the 'UV protected' label from the top of your glazing sheets and remove any left over residue.

*Please note: Continue to treat your building annually after completing construction. To avoid getting treatment on the glazing, apply tape around the edge of each glazed panel and remove once fully treated.*

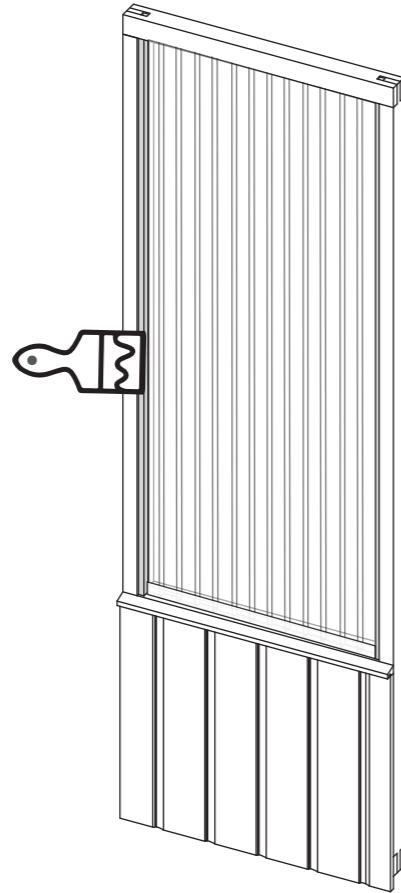

Apply treatment.

## LEAVE US A REVIEW...



Want to share your experience with us?  
Leave us a review on Feefo, TrustPilot or Google.

Your reviews help other people find and trust our business, as well as helping to play an important role in our growth and improvement!

## 1 Perimeter

---

Check around the perimeter of your product to ensure there are not trees or plants that are in contact with or overhanging the building. This can affect airflow and overhanging trees, or branches can damage the roof, it is advised to keep plants at a distance.

## 2 Repair

---

Inspect the interior and exterior of the product to look for splits, cracks, and holes. Although this is a natural occurrence it can be prevented. A wood filler can be used to close the splits, cracks, and holes.

## 3 Roof

---

Check your roof regularly for tears, splits, damaged wood and fallen debris. If you notice any of this immediate repair is critical.

## 4 Doors & Windows

---

Expansion and contraction can cause doors and windows to stick or become difficult to open. Small adjustments to the hinge position can be made to the doors and windows to allow free movement.

## 5 Oil

---

Hinges can seize up over time, apply lubricant to the hinges and locks annually.

## 6 Screws & Bolts

---

It is advised to check all screws and bolts and tighten any loose you might find. For log cabins specifically the storm braces will require loosening. During humidity and temperature changes (seasons) to allow expansion and contraction to prevent gaping, twisting, popping, and warping.

## 7 Wash

---

At least once a year, give the outside of your building a good wash, to remove cobwebs, leaves, or any other dirt that may accumulate on the exterior.

## 8 Airing

---

Airing your product regularly prevents the build up of condensation which can cause the timber to warp, bow, boards to pop, distortion, rot and mould. Condensation can build up over time or daily, it is caused by a rise and fall in temperature.

Excessive moisture levels within your building can cause water to collect on the roofs, walls and floors internally. Leaving doors and windows open regularly can help combat the natural moisture build up.

## 9 Clean & Tidy

---

It is good practice to clean the inside and outside of your product regularly. Clear out the contents, sweep the floor, remove dirt and cobwebs. Check for areas of damp and investigate the cause to remove and prevent future occurrences. Check the ground around your product for build up of debris such as leaves, remove and ensure there is clear ventilation underneath the floor.

All our garden buildings have been designed and manufactured with care and attention to be the perfect addition to your outdoor space. To ensure you do get the best out of your new garden building and to increase the longevity we advise that you follow the product instructions and our manufacturer's recommendations as detailed below. Thank you for choosing a Mercia Garden product!

## 1 Choosing the most suitable location for your garden building...

A minimum of 60cm should be left around the perimeter of your garden building to allow access for maintenance, annual treatment and to allow air flow around the building.

Where possible you should avoid placing your garden building underneath large trees to prevent the tree causing damage to the building.

## 2 Preparing the base for your garden building...

All our buildings must be built on a firm, level base to ensure the longevity of the building and prevent the wood from distorting. We recommend either concrete, concrete slabs or a wooden base, such as our 'Portabase'.

The base should be slightly smaller than the external measurement of the building, i.e. the cladding should overlap the base, creating a run off for water and preventing water from pooling underneath the building.

We also recommend that the floor of the garden building is a minimum of 25mm above the surrounding ground level to avoid flooding.

## 3 After installation...

Once your garden building has been installed, it will need to be treated within 14 days (weather permitting) and annually to prevent the timber from deteriorating and to waterproof it. This is required to maintain the anti-rot guarantee.

Dip Treated buildings - Require a preservative treatment to protect against rot and decay

and a waterproof treatment to prevent water ingress.

Pressure Treated buildings - Require a waterproof treatment to prevent water ingress.

Log Cabins/Insulated Garden Rooms - Are supplied untreated and require a preservative and waterproofing treatment.

We also recommend using a silicon sealant on the inside and outside of the windows as soon as possible after assembly and treatment to fully seal the windows.

Roofing felt/covering should be checked annually and replaced or fixed accordingly.

## 4 General maintenance and wood characteristics

As wood is a natural material it may be affected by the following:

Shrinkage and warping - The timber used in the construction of your garden building will have retained some of its natural moisture content. The moisture content of the timber will vary, depending upon prevailing environmental conditions, which will result in the components either naturally expanding or contracting. As the components dry out, shrinkage may occur. A good waterproofing treatment from the start is the best protection to minimise the effect of moisture loss/intake.

In extended periods of very warm weather getting some moisture to the building will help the overall balance. You can do this by spraying it down lightly with a garden hose. In contrast, after snow fall try to remove the snow as best as possible from the roof to prevent moisture intake and to remove the extra weight.

**Top tip** - using a garden brush will help you to reach the highest part of the building to remove snow and any debris left from bad weather.

Damp and mould - During the winter months, cold and damp conditions can result in an increased amount of moisture within your garden building, especially when used infrequently. Condensation can form on the timber and other items stored within your garden building. If left this moisture is likely to cause mould and mildew.

To prevent the build-up of moisture, we recommend leaving the door or windows of your building open from time to time, to allow the fresh air to circulate. We also advise against storing wet or damp items in your garden building as this will also increase the level of moisture in the building. If mould or mildew does start to form within your building we recommend using an anti-mould cleaner to remove it and to prevent it spreading, which if left untreated could permanently damage your garden building.

Splits, cracks and knots - You may notice small splits and cracks in some components or holes may appear where knots shrink and fall out. This will not affect the structure of your Garden building however, if you wish to fill them this can be easily done using any good quality wood filler.

Sap - is naturally occurring in wood and may appear in some boards of your garden building. If you wish to remove the sap, we advise waiting until it is dry and then using a sharp knife to carefully remove it. If the removal of the sap causes a hole in the timber, we recommend using a good quality wood filler to fill it.



### Any further questions?

Contact our Customer Service Team via the MGP Customer Portal at: [www.mgplogistics.co.uk](http://www.mgplogistics.co.uk)

For more handy hints and tips on how to care and maintain your garden building please refer to the MGP Customer Portal at: [www.mgplogistics.co.uk](http://www.mgplogistics.co.uk)

1

## Manufacturer's Warranty

All Mercia Garden Products are supplied with a 1 year warranty on all parts against manufacturing defects. This warranty does not cover movement, warping or splitting of timber products over time.

This warranty will be voided if any of the following occur:

1. The building has been customised or modified/adapted in any way.
2. The person claiming is not the original purchaser of the building.
3. Any damage has been caused by or as a result of misuse.
4. The building has not been maintained and cared for in accordance to our advisories and manufacturer's recommendations.
5. The building has not been treated annually or as per the manufacturer's recommendations, please ensure receipts are kept to validate this claim.
6. The building has not been erected, fitted or installed as per the supplier instructions.
7. The building has not been erected on a suitable sized firm flat, solid level concrete/slab base or placed on pressure treated bearers.
8. The building is or has been placed with 2 feet (600mm) of any obstructions (walls, trees, plants, fences etc.) which can allow moisture to penetrate the timber.
9. The roofing felt has been incorrectly fitted or damaged, allowing water ingress, or has not been properly maintained.
10. Any windows and joints have not been sealed, inside and out, with silicone or other watertight sealant.
11. Any timber has been cut, pierced or drilled without subsequent application of approved cut-end treatment.

REGISTER FOR YOUR  
**15 YEAR**  
**ANTI-ROT**  
GUARANTEE TODAY



[www.mgplistics.co.uk](http://www.mgplistics.co.uk)

2

## Anti-rot Guarantee

Mercia Garden Products offer a 15 year anti-rot guarantee on dip treated (a preparatory treatment) and 20 years on pressure treated products within this range. This guarantee covers solid timber against rot, decay, blue stain and insect attacks.

To validate the guarantee, the building must be treated (as detailed within manufacturer's recommendations) within 14 days (weather permitting) of assembly and annually thereafter. This guarantee does not cover movement, warping or splitting of timber products over time.

This guarantee will be voided if any of the following occur:

1. The building has been customised or modified/adapted in any way.
2. The person claiming is not the original purchaser of the building.
3. Any damage is caused by or as a result of misuse.
4. The building has not been maintained and cared for in accordance to our advisories and manufacturer's recommendations.
5. The building has not been treated annually or as per the manufacturer's recommendations, please ensure receipts are kept to validate this claim.
6. The building has not been erected, fitted or installed as per the supplier instructions.
7. The building has not been erected on a suitable sized firm flat, solid level concrete/slab base or placed on pressure treated bearers.
8. The building is or has been placed with 600mm of any obstructions (walls, trees, plants, fences etc.) which can allow moisture to penetrate the timber.
9. The roofing felt has been incorrectly fitted or damaged allowing water ingress, or has not been properly maintained.
10. Any windows and joints have not been sealed, inside and out, with silicone or other watertight sealant.
11. Any timber has been cut, pierced or drilled without subsequent application of approved cut-end treatment.